

# C1900 Series Circular Chart Recorders

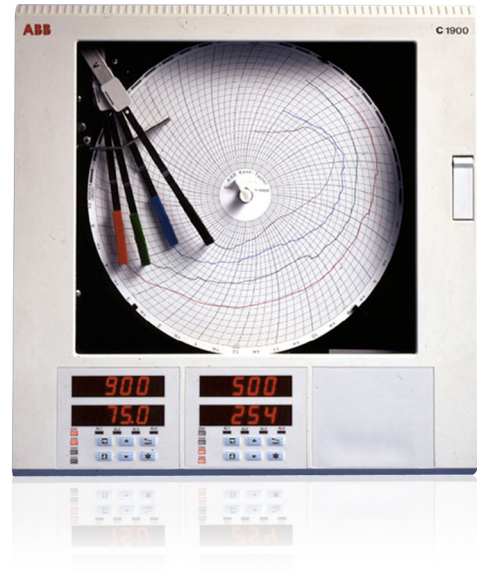

# The Company

We are an established world force in the design and manufacture of measurement products for industrial process control, flow measurement, gas and liquid analysis and environmental applications.

As a part of ABB, a world leader in process automation technology, we offer customers application expertise, service and support worldwide.

We are committed to teamwork, high quality manufacturing, advanced technology and unrivalled service and support.

The quality, accuracy and performance of the Company's products result from over 100 years experience, combined with a continuous program of innovative design and development to incorporate the latest technology.

EN ISO 9001:2000



Cert. No. Q 05907

EN 29001 (ISO 9001)



Lenno, Italy – Cert. No. 9/90A

Stonehouse, U.K.



## Electrical Safety

This equipment complies with the requirements of CEI/IEC 61010-1:2001-2 'Safety Requirements for Electrical Equipment for Measurement, Control and Laboratory Use'. If the equipment is used in a manner NOT specified by the Company, the protection provided by the equipment may be impaired.

## Symbols

One or more of the following symbols may appear on the equipment labelling:

	<b>Warning</b> – Refer to the manual for instructions
	<b>Caution</b> – Risk of electric shock
	Protective earth (ground) terminal
	Earth (ground) terminal

	Direct current supply only
	Alternating current supply only
	Both direct and alternating current supply
	The equipment is protected through double insulation

Information in this manual is intended only to assist our customers in the efficient operation of our equipment. Use of this manual for any other purpose is specifically prohibited and its contents are not to be reproduced in full or part without prior approval of the Technical Publications Department.

### Health and Safety

To ensure that our products are safe and without risk to health, the following points must be noted:

1. The relevant sections of these instructions must be read carefully before proceeding.
2. Warning labels on containers and packages must be observed.
3. Installation, operation, maintenance and servicing must only be carried out by suitably trained personnel and in accordance with the information given.
4. Normal safety precautions must be taken to avoid the possibility of an accident occurring when operating in conditions of high pressure and/or temperature.
5. Chemicals must be stored away from heat, protected from temperature extremes and powders kept dry. Normal safe handling procedures must be used.
6. When disposing of chemicals ensure that no two chemicals are mixed.

Safety advice concerning the use of the equipment described in this manual or any relevant hazard data sheets (where applicable) may be obtained from the Company address on the back cover, together with servicing and spares information.

# CONTENTS

Section	Page
<b>1 INTRODUCTION .....</b>	<b>1</b>
<b>2 GENERAL PROGRAMMING .....</b>	<b>2</b>
2.1 Preparation for Changes to the Parameters .....	2
2.2 Security System .....	2
<b>3 BASIC CONFIGURATION LEVEL .....</b>	<b>3</b>
3.1 Set Up Input (Process Variable) .....	4
3.2 Set Up Pen Range/Event Source .....	8
3.3 Set Up Chart .....	9
3.4 Set Up Alarms .....	10
3.5 Set Up Relay Output .....	15
3.6 Set Up Digital Output .....	17
3.7 Set Up Analog Output .....	19
3.8 Digital Inputs .....	21
3.9 Access Page .....	22
3.10 Scale Adjust .....	23
<b>4 ADVANCED CONFIGURATION LEVEL .....</b>	<b>26</b>
4.1 Set Up Function Keys .....	27
4.2 Set Up Logic .....	28
4.3 Set Up Pen Functions .....	31
<b>5 CONNECTIONS &amp; LINKS .....</b>	<b>32</b>

# 1 INTRODUCTION

The documentation for the C1900 series of circular chart recorders is shown in Fig. 1.1. The **Standard Manuals**, including the data sheet, are supplied with all instruments. The **Supplementary Manuals** supplied depend on the specification of the instrument.

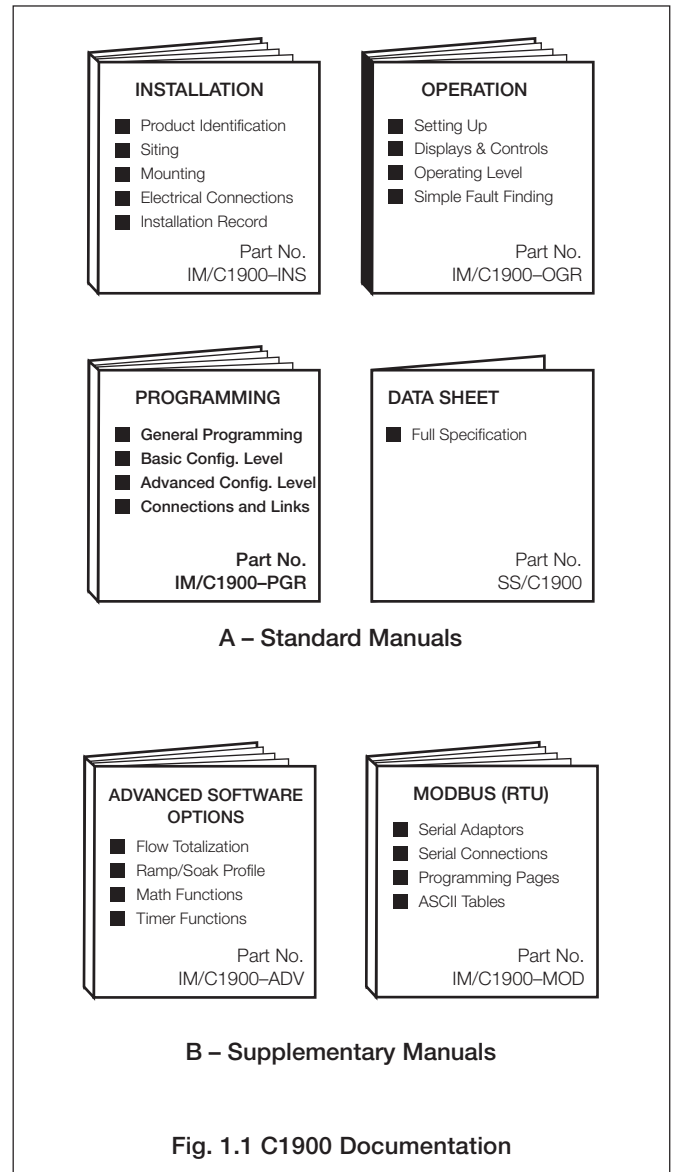

Fig. 1.1 C1900 Documentation

## 2 GENERAL PROGRAMMING

The programming procedures are used to make changes to the operating parameter values and for scale adjustment.

The programming of all channels is performed using faceplate 1 – see Fig. 2.1.

When changing the input type it may be necessary to reposition the input selector links accordingly – see Section 5, **CONNECTIONS & LINKS**.

### 2.1 Preparation for Changes to the Parameters

Isolate all external alarm/control circuits to prevent inadvertent operation during programming.

Changes to the operating parameters are implemented using the ▲ or ▼ keys – see Section 3 of the **Operating Guide**.

---

**Note.** The recorder responds instantly to parameter changes which are saved automatically when leaving the current frame.

---

### 2.2 Security System

A security system is used to prevent tampering with the programmed parameters by restricting access to programming levels, other than the **OPERATOR LEVEL**; all users have access to this level.

A security password is used to give access to the programming pages. The password can be set to any value from 0 to 9999. The recorder is despatched with the password set to '0' – see Section 4.5 of **Operating Guide**.

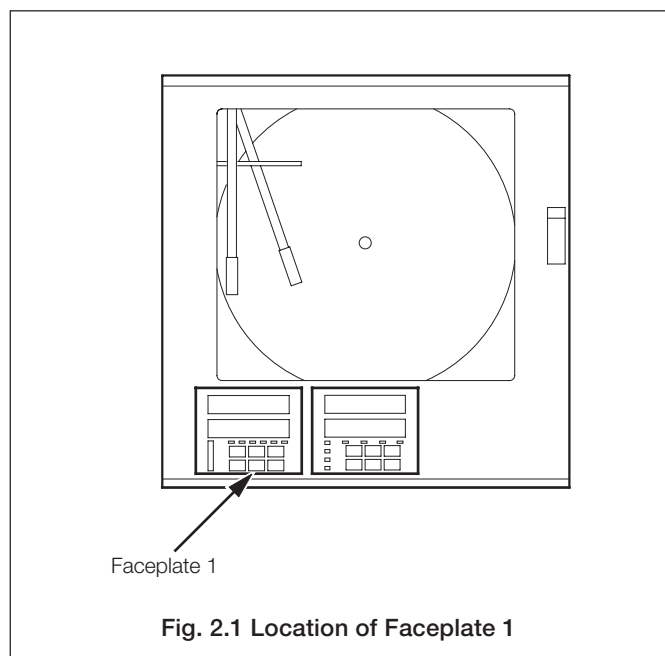

### 3 BASIC CONFIGURATION LEVEL

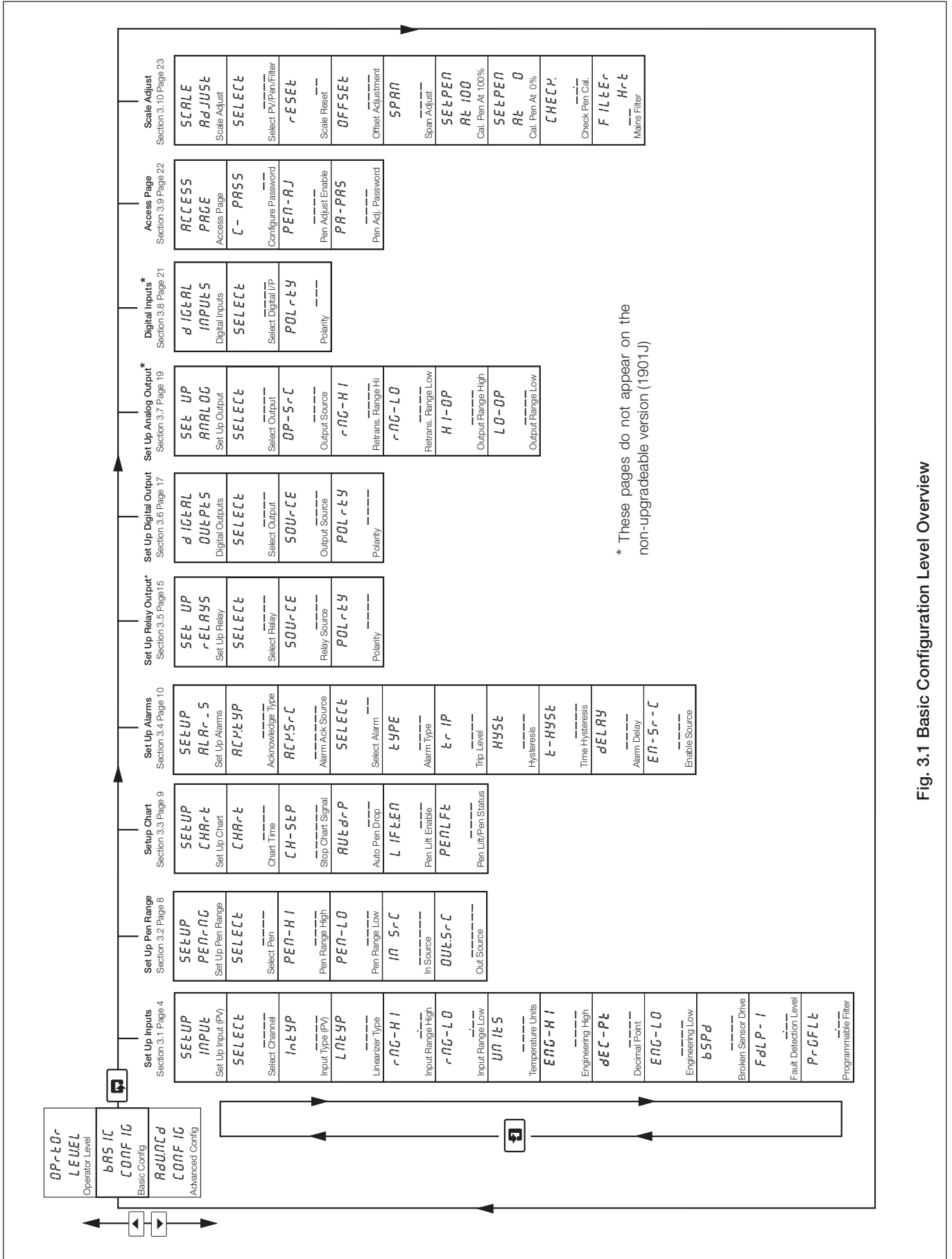

Fig. 3.1 Basic Configuration Level Overview

### ...3 BASIC CONFIGURATION LEVEL

#### 3.1 Set Up Input (Process Variable)

**Information.**

- **Universal inputs** – mV, mA, V, THC, RTD and resistance.
- **Internal cold junction compensation.**
- **Linearization** – of temperature sensors to allow use of non-linearizing transmitters or any electrical input.
- **Programmable fault levels and actions.**
- **Digital filter** – to reduce the effect of noise on inputs.

**Example A – setting up:**

- a current input of 4 to 20mA
- displaying a range of 0 to 200psi
- a fault detection level 10% above 200psi (engineering/display range) and 10% below 0psi (engineering/display range)
- in the event of a fault being detected and/or the fault detection level being exceeded the process variable is driven downscale.

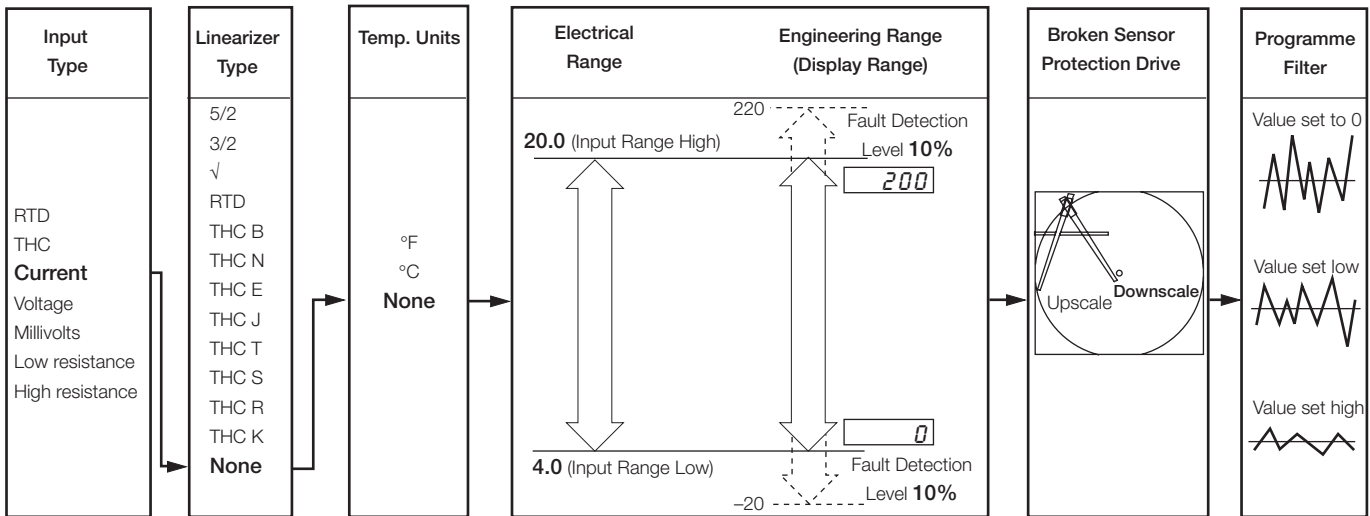

**Example B – setting up:**

- a Type K thermocouple
- displaying temperature in °F
- displaying a range of 0 to 2000°F
- a fault detection level 10% above 2000°F (engineering/display range) and 10% below 0°F (engineering/display range)
- in the event of a fault being detected and/or the fault detection level being exceeded the process variable is driven upscale.

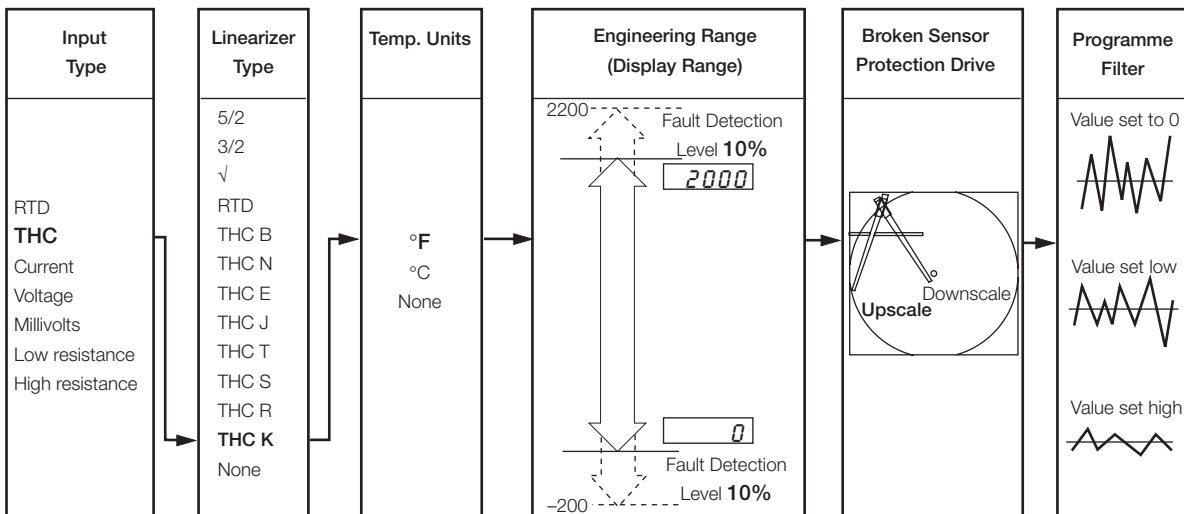

...3.1 Set Up Input (Process Variable)

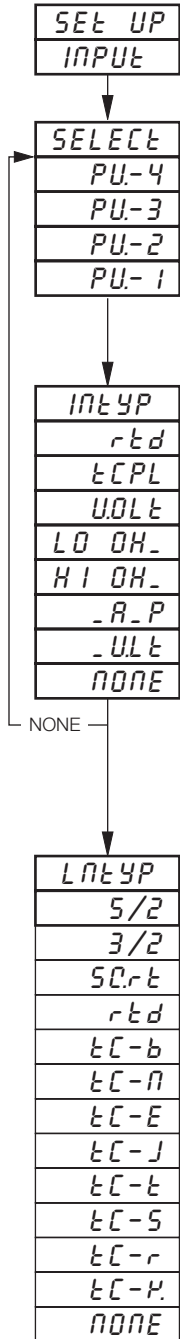

Page Header – Set Up Input (Process Variable)

To advance to Set Up Pen Range Page press the key.

**Select Channel**

Select the channel to be programmed:

- PU- 1 – Channel 1
- PU- 2 – Channel 2
- PU- 3 – Channel 3
- PU- 4 – Channel 4

**Note.** In the remaining frames press the key to view the channel selected.

**Input Type (Process Variable)**

**Caution.** Ensure the correct input link positions are selected and the input is wired correctly – see Section 5, CONNECTIONS & LINKS.

Select the input type required:

- rtd – Resistance thermometer
- tCPL – Thermocouple
- UDLt – Voltage
- LO OH\_ – Low resistance ( $\leq 750\Omega$ )
- HI OH\_ – High resistance ( $> 750\Omega$ )
- A-P – Current
- ULt – Millivolt ( $\leq 150\text{mV}$ )
- NONE – None

**Linearizer Type**

Select the linearizer type required:

- 5/2 –  $x^{5/2}$
  - 3/2 –  $x^{3/2}$
  - SQ.r.t – Square Root
  - rtd – Resistance thermometer
  - tC-b – Type B thermocouple
  - tC-N – Type N thermocouple
  - tC-E – Type E thermocouple
  - tC-J – Type J thermocouple
  - tC-t – Type T thermocouple
  - tC-S – Type S thermocouple
  - tC-r – Type R thermocouple
  - tC-K – Type K thermocouple
  - NONE – No linearizer
- } Open channel flow applications

Continued on next page.

### ...3 BASIC CONFIGURATION LEVEL

#### ...3.1 Set Up Input (Process Variable)

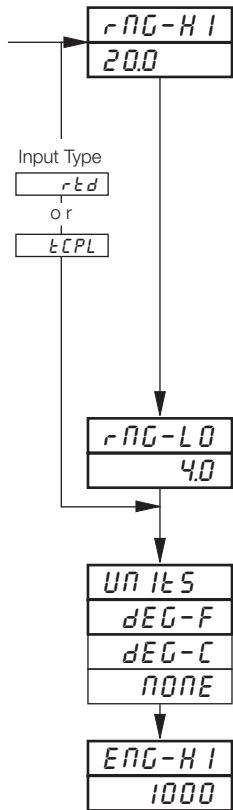

#### Input Range High

Set the maximum electrical input value required (in electrical units).

**Note.** The value set must be within the limits detailed in the table below.

Input Type	Range Low Min.	Range High Max.	Min. Range (Low to High)
Millivolts	0	150	5.0
Volts	0	5	0.1
Milliamps	0	50	1.0
Resistance Low	0	750	20
Resistance High	0	9999	400

#### Input Range Low

Set the minimum electrical input value required (in electrical units).

**Note.** The value set must be within the limits detailed in the above table.

#### Temperature Units

Select units required.

#### Engineering Range High

Set the maximum engineering (display) value required.

**Note.** The value set must be within the limits detailed in the tables below.

Linearizer Type	Degrees Fahrenheit			Degrees Celsius		
	Min.	Max.	Min. Span	Min.	Max.	Min. Span
Type B	0	3272	1278	-18	1800	710
Type E	-148	1652	81	-100	900	45
Type J	-148	1652	90	-100	900	50
Type K	-148	2372	117	-100	1300	65
Type N	-328	2372	162	-200	1300	90
Type R & S	0	3092	576	-18	1700	320
Type T	-418	572	108	-250	300	60
RTD	-328	1112	45	-200	600	25

Performance accuracy is not guaranteed below 725°F/400°C for types B, R and S thermocouples.

Minimum span below zero Type T 126°F/70°C

Minimum span below zero Type N 189°F/105°C

THC standard DIN 4730 IEC 584

RTD standard DIN 43760 IEC 751

Linearizer Type	Engineering Range High and Low	
	Min.	Max.
5/2	-9999	+9999
3/2		
Square Root		
None		

Continued on next page.

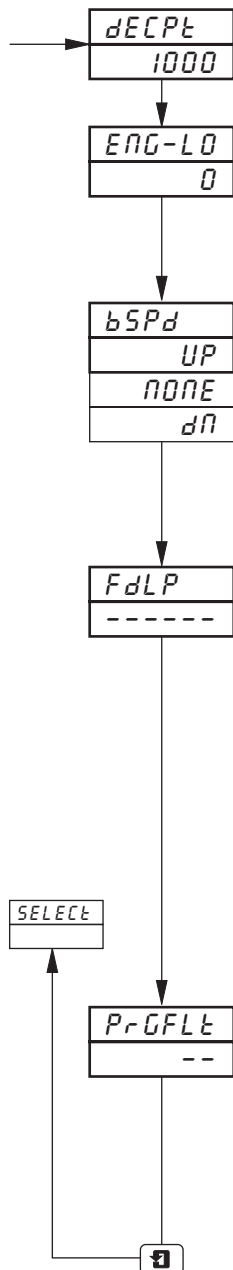

## ...3.1 Set Up Input (Process Variable)

**Decimal Point**

Set the decimal point position required for **both** the engineering range high and engineering range low values.

**Engineering Range Low**

Set the minimum engineering (display) value required,

**Note.** The value set must be within the limits detailed in **Engineering Range High** tables opposite.

**Broken Sensor Protection Drive**

In the event of a fault being detected on the input and/or if the **Fault Detection Level Percentage** is exceeded (see next frame), the process variable is driven in the direction of the drive selected.

Select the broken sensor drive required:

- none* - No drive
- UP* - Upscale drive
- dN* - Downscale drive.

**Fault Detection Level Percentage**

A fault level percentage can be set to detect a deviation above or below the display limits.

For example, if *FdLP* is set at 10.0%, a fault is detected if an input goes more than 10% above **Engineering Range High** or more than 10% below **Engineering Range Low**.

On some ranges the input circuitry may saturate before the fault level set is reached. In this case an error is detected below the level set.

Set the level required, between 0.0 and 100.0% of engineering span (range low to high) in 0.1% increments.

**Note.** If an input exceeds the minimum or maximum value for the linearizer selected an error is detected regardless of any fault level.

**Programmable Filter**

Filters the process variable input, i.e. if the input is stepped it smooths the transition between steps and may also be used for some degree of cleaning of noisy inputs. The filter time represents the time a step in the input takes to change the displayed process variable from 10 to 90% of the step.

Set the value required, between 0 and 60 in 1 second increments.

Return to **Select Channel** frame.

3.2 Set Up Pen Range/Event Source

Information.

- **Trend pens** – have an independent chart range allowing a selected part of the engineering (display) range to be used for extra resolution on the chart.
- **Three position event pen function** – can be driven by digital inputs, alarms, logic equation results and real time events (when timer option is fitted).

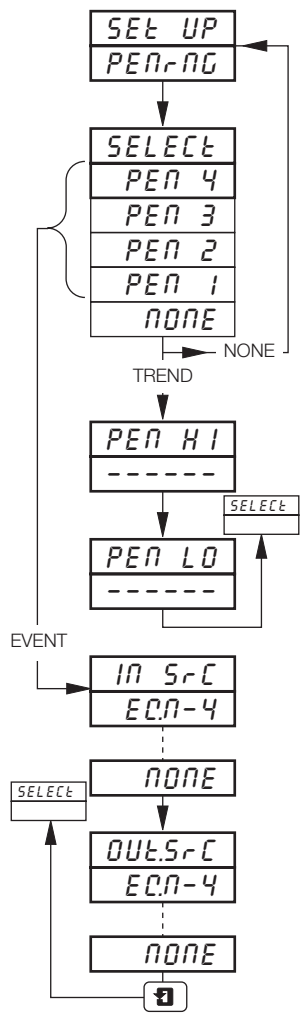
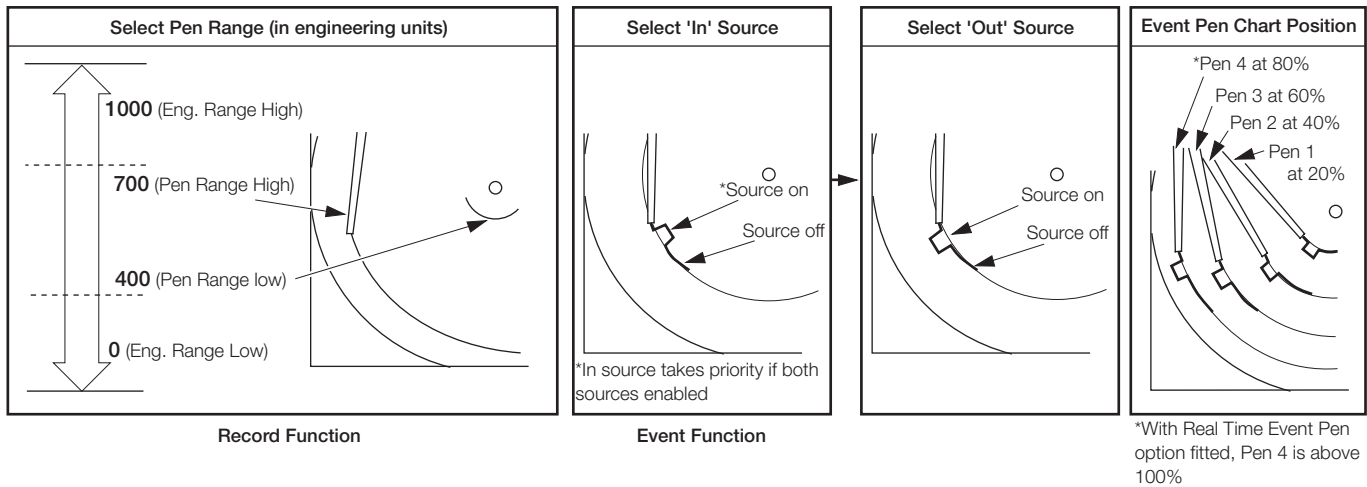

Page Header – Set Up Pen Range

To advance to **Set Up Chart Page** press the key.

**Select Pen**

Select the pen to be programmed

**Note.**

- In the remaining frames press the key to view the pen selected.
- Record (trend) or event pen function is set in the **ADVANCED CONFIGURATION LEVEL** (if True Time Event Pen option is selected, the fourth pen is fitted with a special pen arm and is set automatically for event pen function) – see Section 4.3, **Set Up Pen Functions**.

**Pen Range High**

Set the maximum value required on the chart, in engineering units (the value must be within the engineering range set in **Set Up Input Page** – see Section 3.1).

**Pen Range Low**

Set the minimum value required on the chart, in engineering units (the value must be within the engineering range set in **Set Up Input Page**).

**In Source**

Select a source to move the pen inwards on the chart.

For a description of sources – see **Table 3.1** on page 16.

**Out Source**

Select a source to move the pen outwards on the chart.

For a description of sources – see **Table 3.1** on page 16.

Return to **Select Pen** frame.

### 3.3 Set Up Chart

**Information.**

- **Programmable chart duration** – between 1 and 167 hours or 7 and 32 days.
- **Chart stop function** – the chart can be stopped by an alarm, digital input, logic equation result or a real time event (if timer option is fitted).
- **Auto pen drop** – automatically drops the pen(s) onto the chart after a 5 minute delay to ensure recording is not left disabled inadvertently.

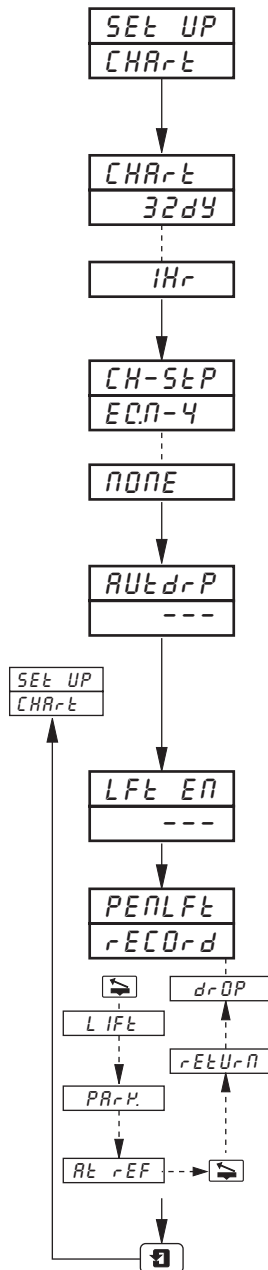

Page Header – **Set Up Chart**

To advance to **Set Up Alarms Page** press the key.

**Chart Duration**

Select the chart duration required per revolution of the chart; between 1 and 167 hours or 7 and 32 days.

**Stop Chart Source**

Select the source required for stopping the chart.

For a description of sources – see **Table 3.1** on page 16.

**Auto Pen Drop**

Select 'YES' to enable or 'NO' to disable.

If 'YES' selected, pen(s) drop automatically onto the chart 5 minutes after they are lifted.

If 'NO' selected, the pen(s) remain lifted until they are manually dropped by the operator.

**Pen Lift Enable/Disable**

The key can be disabled if required. Select 'YES' to enable or 'NO' to disable.

**Pen Lift/Pen Status**

To raise pen(s) press key. The following status displays are shown:

- rECOrd* – pen records on chart
- L Ift* – pen lifts off chart
- PARk* – pen moves to park position
- At rEF* – pen at reference position

To lower pen(s) press key. The following status displays are shown:

- rEtUrN* – pen returns to record position
- drOP* – drops (lowers) onto chart
- rECOrd* – pen records on chart

Return to top of **Set Up Chart Page**.

3.4 Set Up Alarms

Information.

- **Four alarms per channel** – identified A1 to D1 (for channel 1) up to A4 to D4 (for channel 4).
- **Three operator acknowledge options.**
- **Global alarm acknowledgment** – by digital input, alarm, logic equation result or real time event (if option fitted).
- **High/low process alarms.**
- **Delayed high/low process alarms.**
- **Fast/slow rate of change** – of process variable alarms.
- **Adjustable hysteresis value** – to prevent oscillation of alarm state.
- **Time hysteresis** – to allow delayed triggering of alarms.

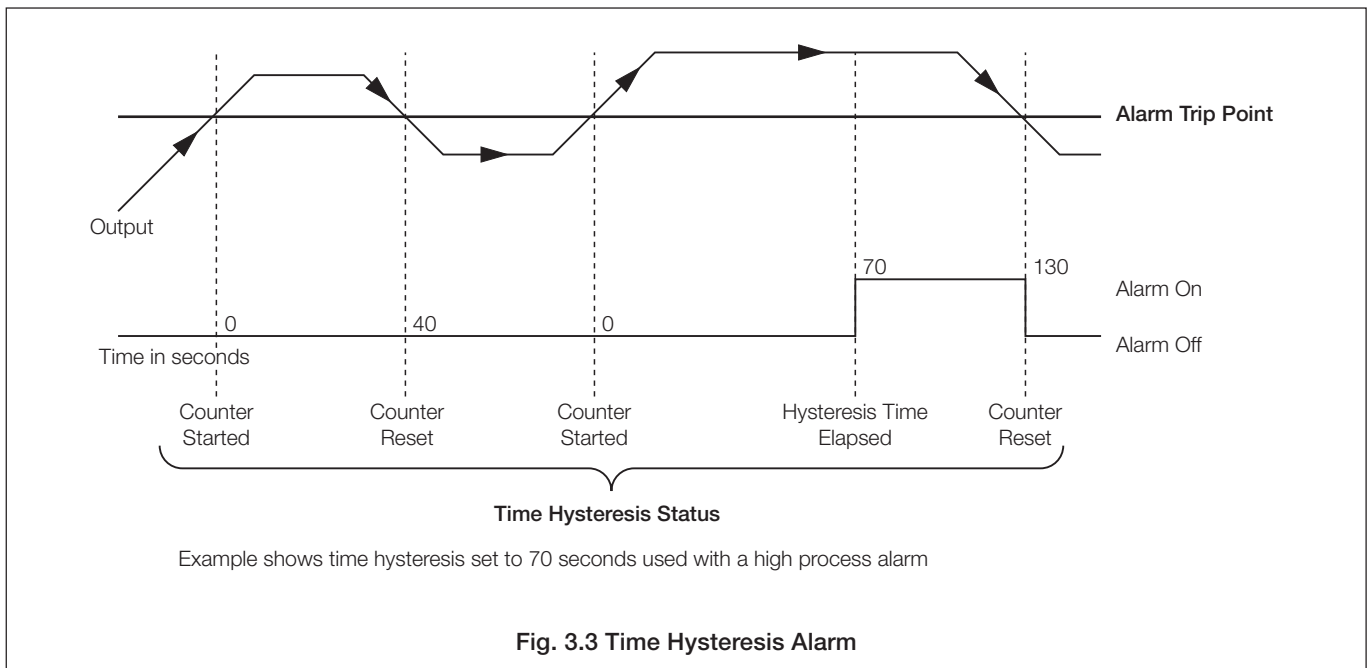
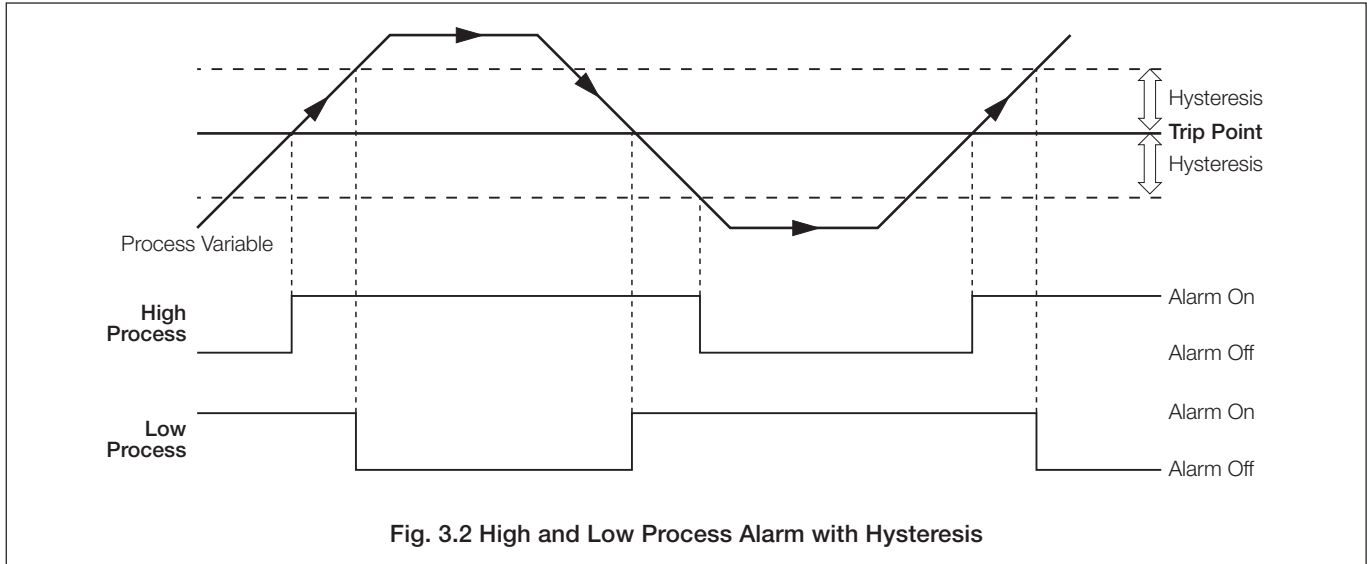

## ...3.4 Set Up Alarms

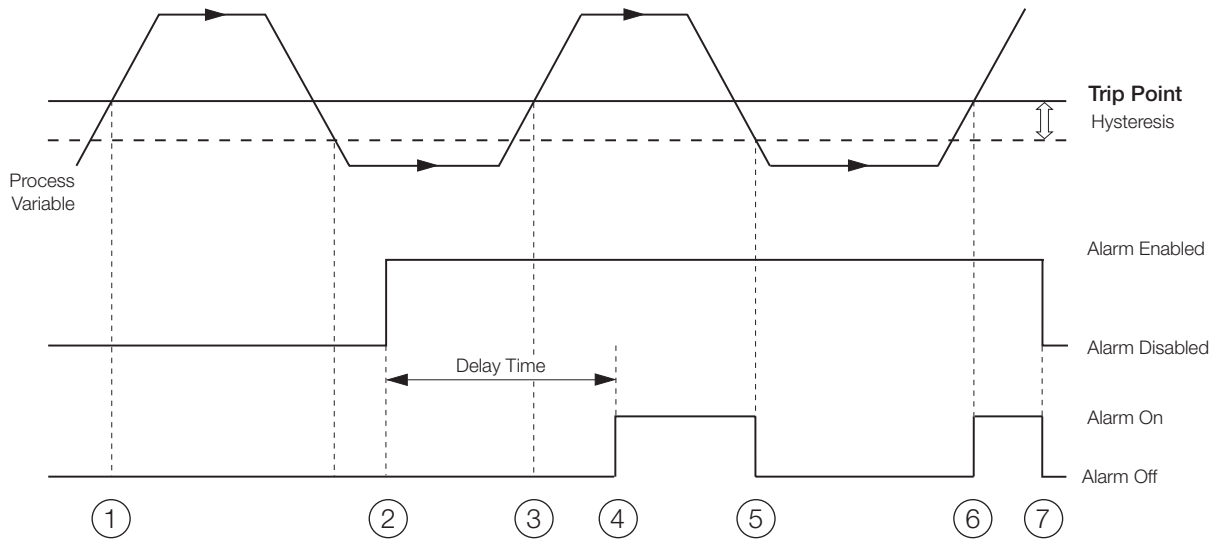

The operation of a delayed high/low process alarm is identical to that of the standard high/low process alarm but the alarm can be enabled/disabled by use of a digital signal.

The alarm state is held off whilst the enable signal is off and continues to be held off for a pre-configured period of time after the enable signal is switched ON (irrespective of the process variable value). Once the pre-configured alarm delay time has expired then the alarm operates in the same manner as a standard high/low process alarm.

- ① Process variable goes above trip point but alarm is not activated because enable signal is low (Alarm Disable).
- ② Alarm Enable signal is switched On. Alarm delay timer started.
- ③ Process variable goes above trip point but alarm is not activated because alarm delay time has not expired.
- ④ Alarm delay timer expires, alarm is now enabled. Alarm is activated because process variable is above trip point.
- ⑤ Process variable goes below trip (hysteresis) point therefore alarm is de-activated.
- ⑥ Process variable goes above trip point, alarm is activated (alarm is enabled and delay time has expired).
- ⑦ Alarm Enable signal is switched Off. Alarm is disabled immediately. Alarm de-activates.

**Fig. 3.4 Delayed High Process Alarm**

### ...3 BASIC CONFIGURATION LEVEL

#### ...3.4 Set Up Alarms

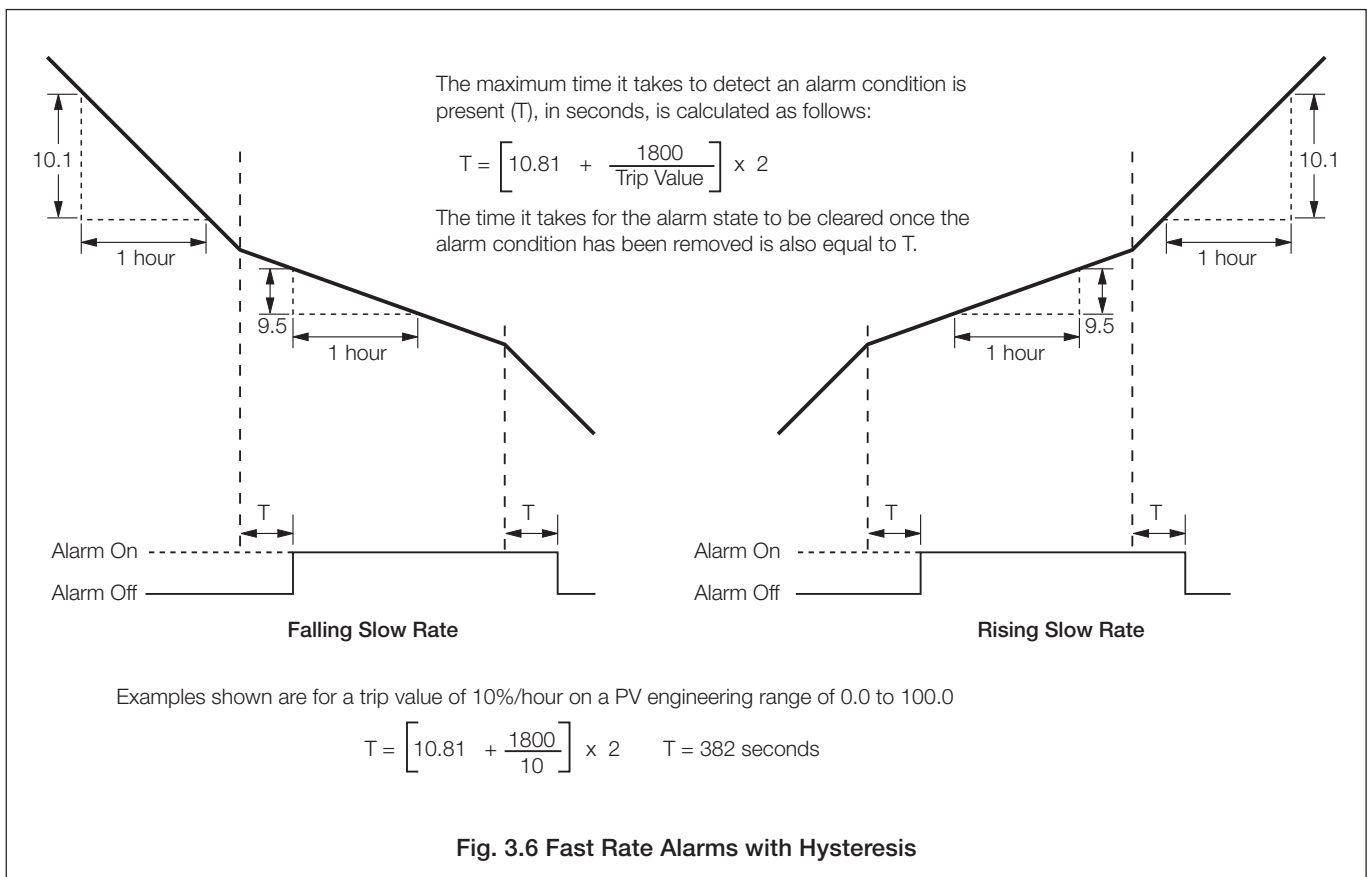
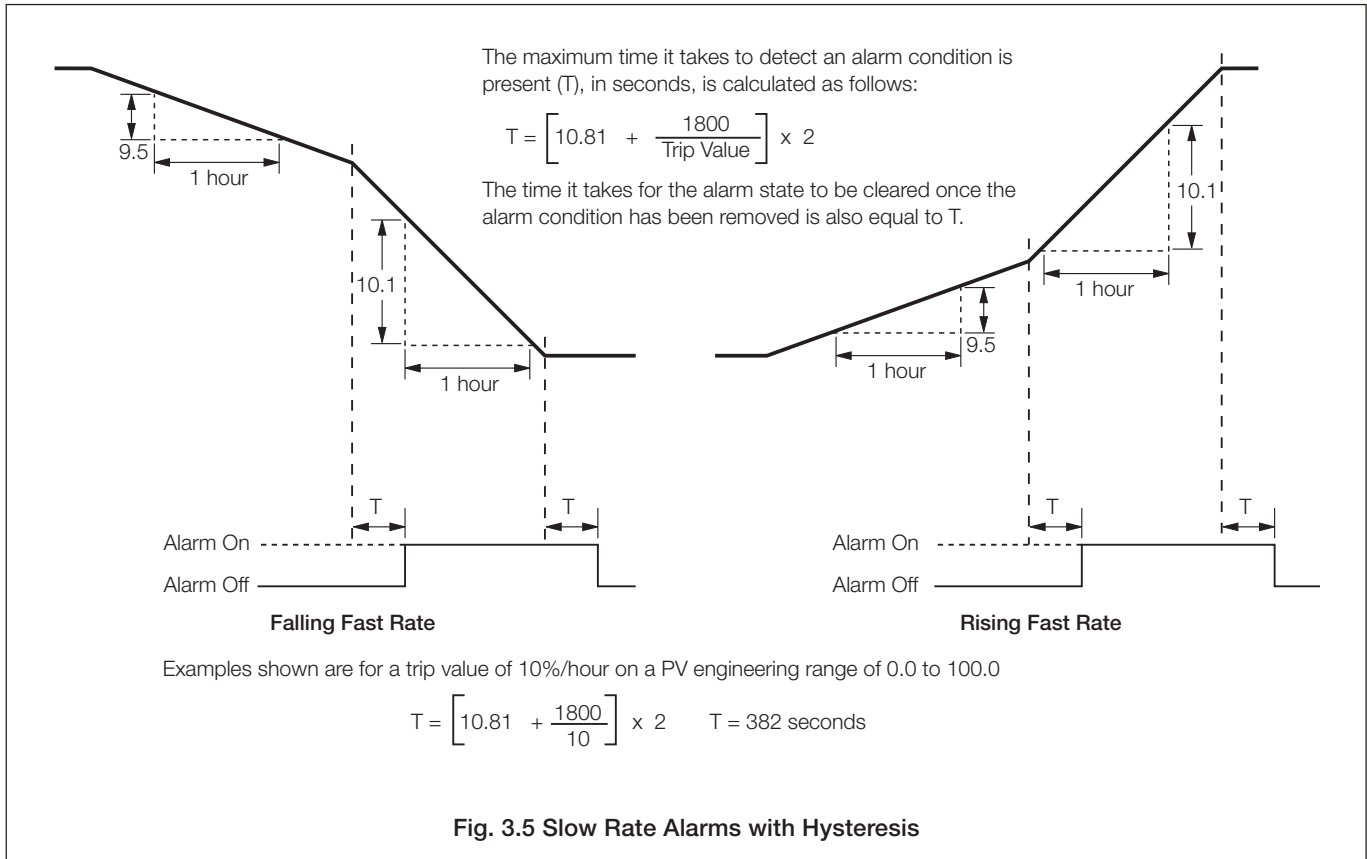

...3.4 Set Up Alarms

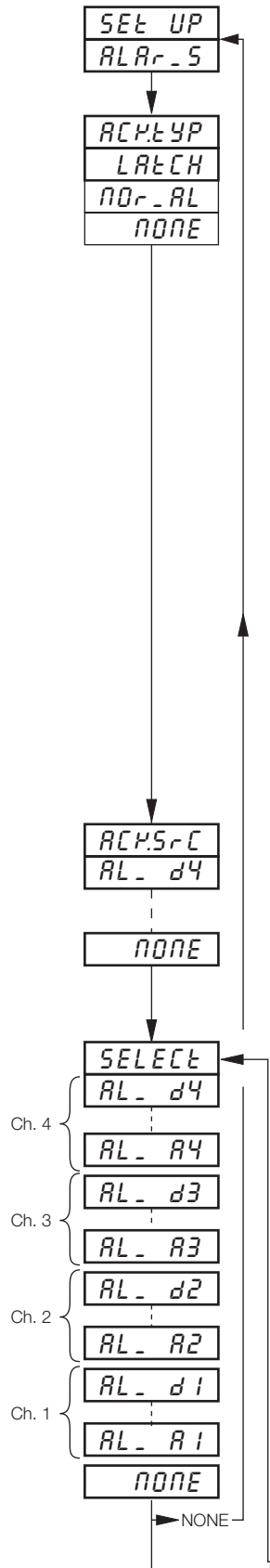

Page Header – Set Up Alarms

To advance to **Set Up Relay Output** page press the key.

**Alarm Acknowledge Type**

Alarms may be acknowledged while they are displayed.

Select the alarm acknowledge type:

*NONE* – no acknowledge facility. If the cause of the alarm no longer exists, the alarm state and display are cleared automatically.

Alarm cause	LED	Alarm State
Present	Flashing	Active
Not Present	Off	Inactive

*NOR\_AL* and *LATCH* – if the cause of the alarm no longer exists, the alarm display remains until it has been acknowledged.

Alarm cause	Acknowledge	LED	Alarm State
Present	No	Flashing	Active
Present	Yes	Steady	Active
Not Present	Previously acknowledged	Off	Inactive
Present	No	Flashing	Active
Not Present	No	Flashing	Active/Inactive*
Not Present	Yes	Off	Inactive

\*Alarm state is active if *LATCH* is selected or inactive if *NOR\_AL* is selected.

**Global Alarm Acknowledge Source**

Select the alarm acknowledgment source required.

For a description of sources – see **Table 3.1** on page 16.

**Select Alarm**

Select the alarm to be programmed.

**Note.** In the remaining frames press the key to view the alarm selected.

Continued on next page.

### ...3 BASIC CONFIGURATION LEVEL

#### ...3.4 Set Up Alarms

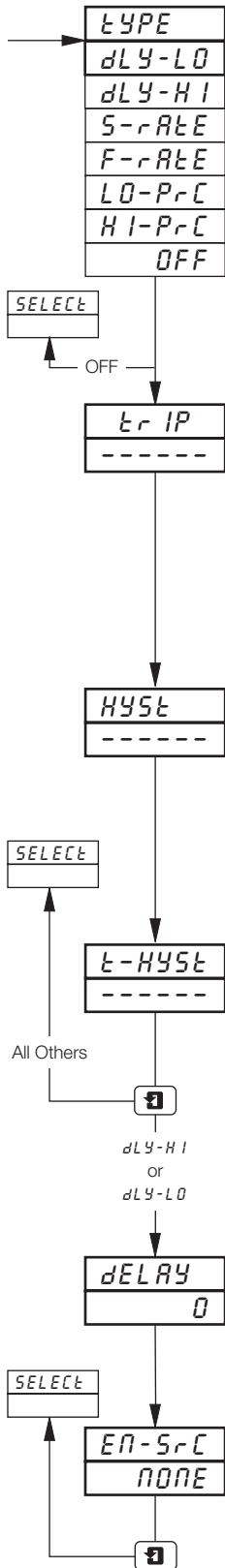

#### Alarm Type

Select the alarm type required for the alarm selected.

- dLY-L0* – delayed low process
- dLY-H1* – delayed high process
- H1-PrC* – high process
- L0-PrC* – low process
- F-rtE* – fast rate (rate of change of process variable)
- S-rtE* – slow rate (rate of change of process variable)
- OFF* – alarm off

#### Trip Level

Set the trip value required for the alarm selected.

The following are displayed in engineering units:

*HPrC, LPrC.*

The following are displayed as a percentage of the engineering span (engineering range high – engineering range low) per hour between  $\pm 0.5$  and  $\pm 500\%$ :

*FrtE* and *SrtE*.

#### Hysteresis

Hysteresis is operational when the alarm is active.

Set the hysteresis value required for high/low process, in engineering units (within the engineering range) or in 0.1% increments for rate alarms. The alarm is activated at the trip level but is only turned off after the alarm variable has moved into the safe region by an amount equal to the hysteresis value. For rate alarms this setting is a percentage of the trip rate – see '*FrtE*' and '*SrtE*' in previous frame.

#### Time Hysteresis

Set the time hysteresis value required between 0 and 9999 seconds.

**Note.** The alarm condition must be present continually for the time set, before the alarm becomes active. If a hysteresis level is also set, the alarm condition remains active until the process variable moves outside the hysteresis band. When the alarm condition no longer exists the alarm becomes inactive, i.e. time hysteresis does not affect turning off of alarm states.

#### Alarm Delay

After a transition of the enable signal from disabled to enabled, the alarm remains disabled for this period of time.

Set 0 to 250 minutes.

#### Enable Source

Any digital signal can be assigned as the signal to enable/disable the alarm.

Return to **Select Alarm** frame.



### 3.5 Set Up Relay Output

**Information.**

- **Relay Output** – not applicable to 1901J (non-upgradeable version).
- **Relays** – can be energized by alarms, logic equation results, digital inputs, real time events (timer option) and totalizer wrap signal (totalizer option).
- **External Totalizer count function** – external counter can only be driven by module type 3 (4 relays module) fitted in module positions 4, 5 and 6.
- **Polarity** – to allow failsafe settings.

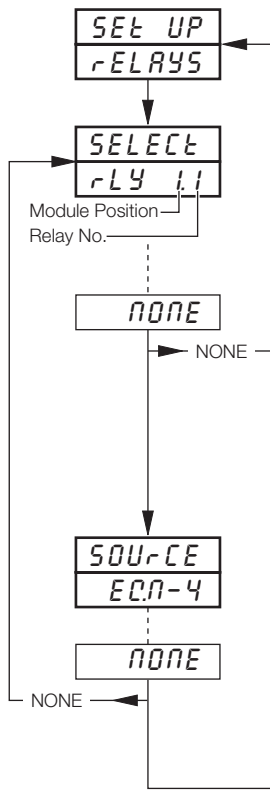
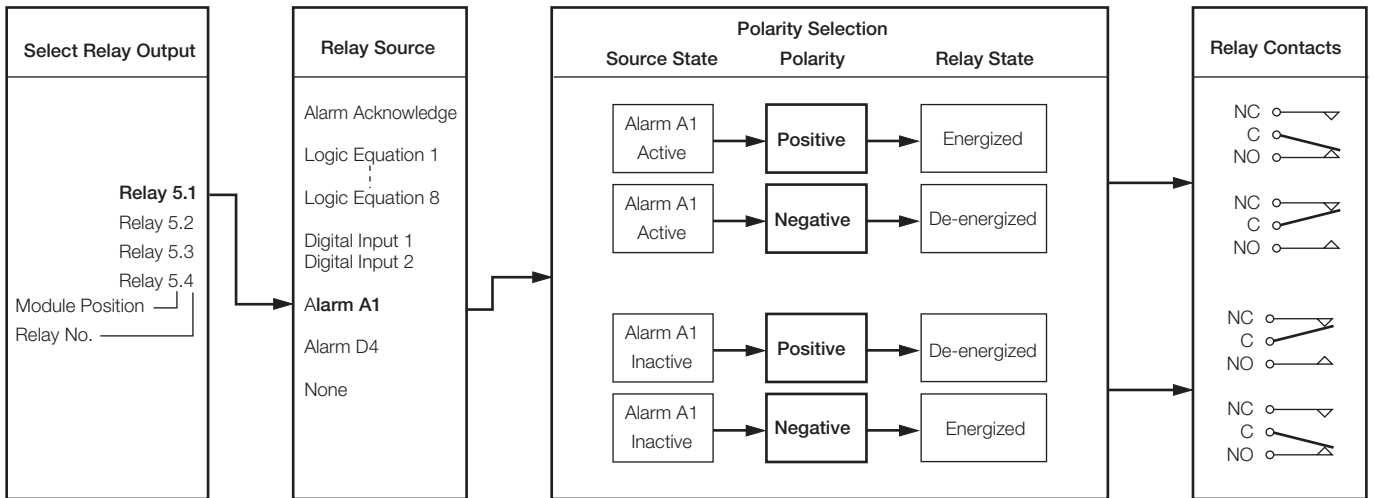

Page Header – Set Up Relays

To advance to **Set Up Digital Output Page** press the key.

**Select Relay Output**

Select the output to be programmed. The selections in this frame relate to the number of fitted modules with relays and their relative module positions.

**Example** – for a type 3 (four relays) module fitted in position five the following selections are also programmable:

- RELAY 5.1 (position 5, relay 1)
- RELAY 5.2 (position 5, relay 2)
- RELAY 5.3 (position 5, relay 3)
- RELAY 5.4 (position 5, relay 4)

**Note.** In the remaining frames press the key to view the relay selected.

**Relay Source**

Select the source required to activate the selected relay.

For a description of sources – see **Table 3.1** on page 16.

**Note.** To drive an external counter **COUNTx** must be selected.

Continued on next page

### ...3 BASIC CONFIGURATION LEVEL

#### ...3.5 Set Up Relay Output

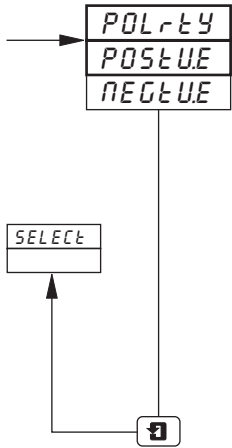

#### Polarity

The polarity selection is used to invert the effect of the digital source state on the relay state as shown in the following table:

Source State	Polarity	Relay State
Active	Positive	Energized
	Negative	De-energized
Non-active	Positive	De-energized
	Negative	Energized

Select the polarity required

**Caution.** Check connections before operating – see Section 5, **CONNECTIONS & LINKS**.

Return to **Select Relay Output** frame.

Source	Description
<i>AL_ACP</i>	Alarm Acknowledge – Unacknowledged process alarm anywhere in the unit
<i>t 1_Er.2</i> <i>t 1_Er.1</i>	Real time event 2 Real time event 1 } Real time events (available only if timer option fitted – see <b>Advanced Software Options Manual</b> ).
<i>EEN-4</i> <i>EEN-3</i> <i>EEN-2</i> <i>EEN-1</i>	Programmable logic equation 4 Programmable logic equation 3 Programmable logic equation 2 Programmable logic equation 1 } Programmable logic equations – see Section 4.2, <b>Set Up Logic</b>
<i>r AP-4</i> <i>*COUNT. 4</i> ⋮ <i>r AP-1</i> <i>*COUNT. 1</i>	Wrap around on total 4 Total 4 external counter drive ⋮ Wrap around on total 1 Total 1 external counter drive } Wrap around and count (available only if totalizer option fitted)
<i>d IG-6.8</i> ⋮ <i>d IG-1.1</i>	Digital Input 6.8 ⋮ Digital input 1.1  ┌ Digital Input number └ Module number
<i>AL-d4</i> <i>AL-c4</i> <i>AL-b4</i> <i>AL-A4</i>	Alarm D Alarm C Alarm B Alarm A } Channel 4 Alarms (if applicable)
<i>AL-d3</i> <i>AL-c3</i> <i>AL-b3</i> <i>AL-A3</i>	Alarm D Alarm C Alarm B Alarm A } Channel 3 Alarms (if applicable)
<i>AL-d2</i> <i>AL-c2</i> <i>AL-b2</i> <i>AL-A2</i>	Alarm D Alarm C Alarm B Alarm A } Channel 2 Alarms (if applicable)
<i>AL-d 1</i> <i>AL-c 1</i> <i>AL-b 1</i> <i>AL-A 1</i>	Alarm D Alarm C Alarm B Alarm A } Channel 1 Alarms
<i>NONE</i>	No source required

\* Available only on 4-relay and 8-digital output modules (types 3 and 5), fitted in module positions 4,5 and 6.

**Table 3.1 Description of Sources**

### 3.6 Set Up Digital Output

**Information.**

- **This page is displayed only if digital outputs are fitted.**
- **Up to 24 digital outputs are available** – depending on the module types fitted.
- **Digital outputs** – can be energized by alarms, logic equations results, digital inputs, real time events (timer option) and totalizer wrap signal (totalizer option).
- **External Totalizer count function** – external counter can only be driven by module type 5 (8 digital outputs module) fitted in module positions 4, 5 and 6.
- **Polarity** – inverts the effect of the selected source on the output state.

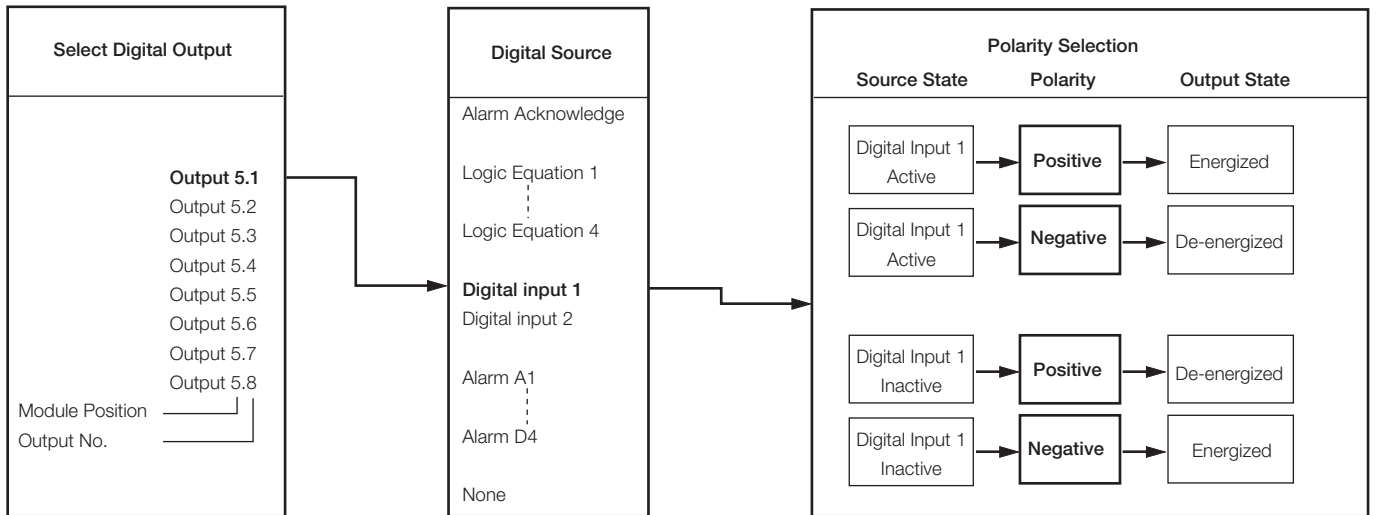

...3.6 Set Up Digital Output

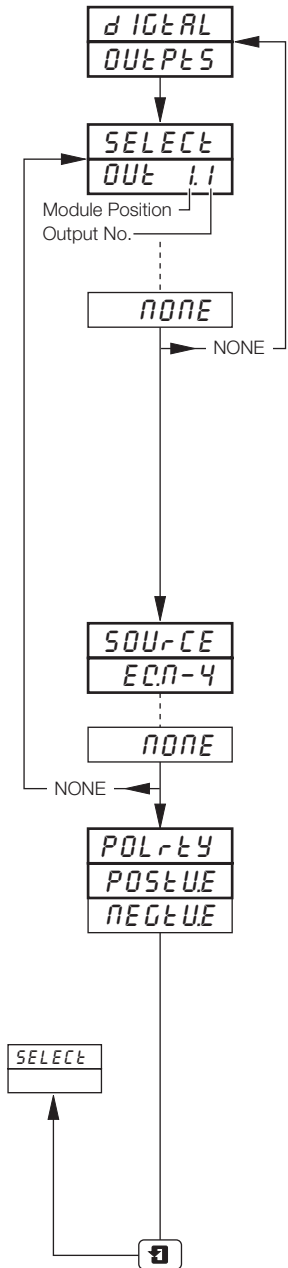

Page Header – Set Up Digital Outputs

to advance to **Set Up Analog Output** page press the key.

**Select Digital Output**

Select the output to be programmed – the selections in this frame relate to the number of fitted digital output modules and their relative module positions.

**Example** – for a type 5 (eight digital outputs) module fitted in position five the following selections are also programmable:

- OUT 5.1 (position 5, output 1)
- OUT 5.2 (position 5, output 2)
- OUT 5.3 (position 5, output 3)
- OUT 5.4 (position 5, output 4)
- OUT 5.5 (position 5, output 5)
- OUT 5.6 (position 5, output 6)
- OUT 5.7 (position 5, output 7)
- OUT 5.8 (position 5, output 8)

**Note.** In the remaining frames press the key to view the output selected.

**Output Source**

Select the source required to activate the selected digital output.

For a description of sources – see **Table 3.1** on page 16.

**Note.** To drive an external counter *COUNTx* must be selected.

**Polarity**

The polarity selection is used to invert the effect of the source state on the output as shown in the following table:

Source State	Polarity	Output State
Active	Positive Negative	Energized De-energized
Non-active	Positive Negative	De-energized Energized

Select the polarity required.

**Caution.** Check connections before operating – see Section 5, **CONNECTIONS & LINKS**.

Return to **Select Digital Output** frame.

### 3.7 Set Up Analog Output

#### Information.

- **Analog Output** – not applicable to 1901J (non-upgradeable version).
- **Fitted analog outputs** – assignable to retransmit any process variable.
- **Selectable retransmission range** – allows maximum resolution on range of interest.
- **Adjustable output range** – for non-standard and reversed outputs.

**Note.** The example below shows analog output 1 set to retransmit part of process variable 1's engineering range (250 to 750°C) as a 4.0 to 20.0mA current output.

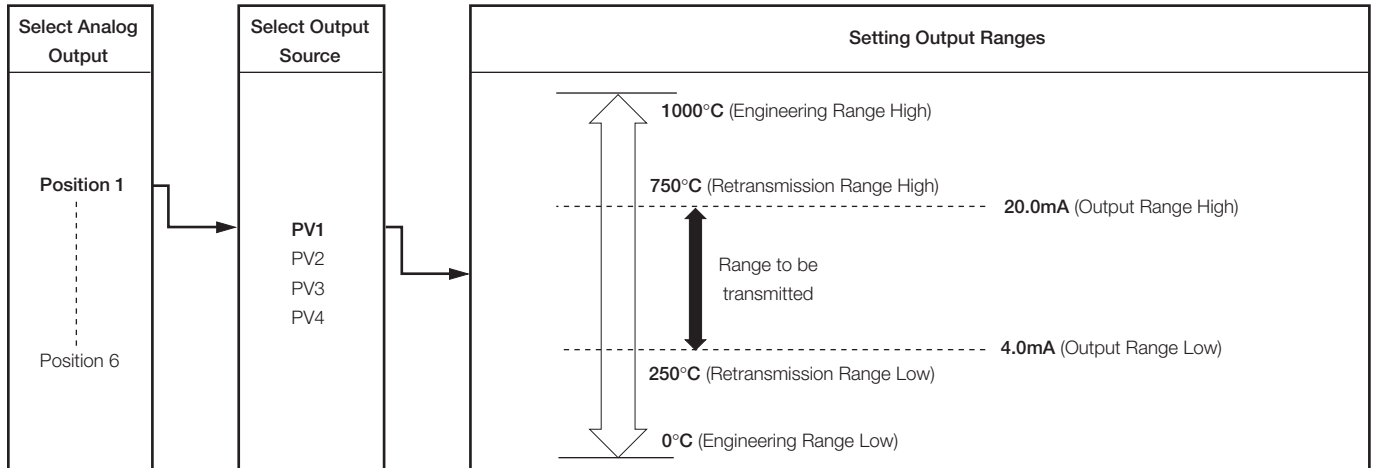



### 3.8 Digital Inputs

**Information.**

- **Digital Input** – not applicable to 1901J (non-upgradeable version).
- **Up to 30 digital inputs are available** – depending on the module types fitted.
- **Volt-free contacts or TTL levels.**
- **Polarity** – sets the logic state (unchanged or inverted) for the module position(s).

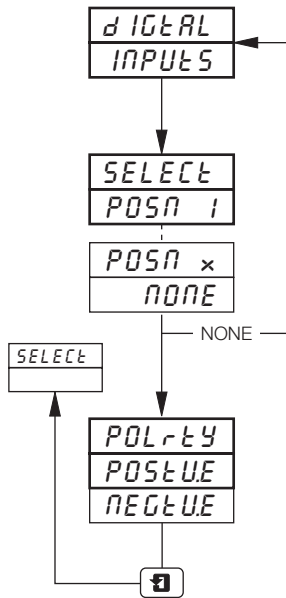
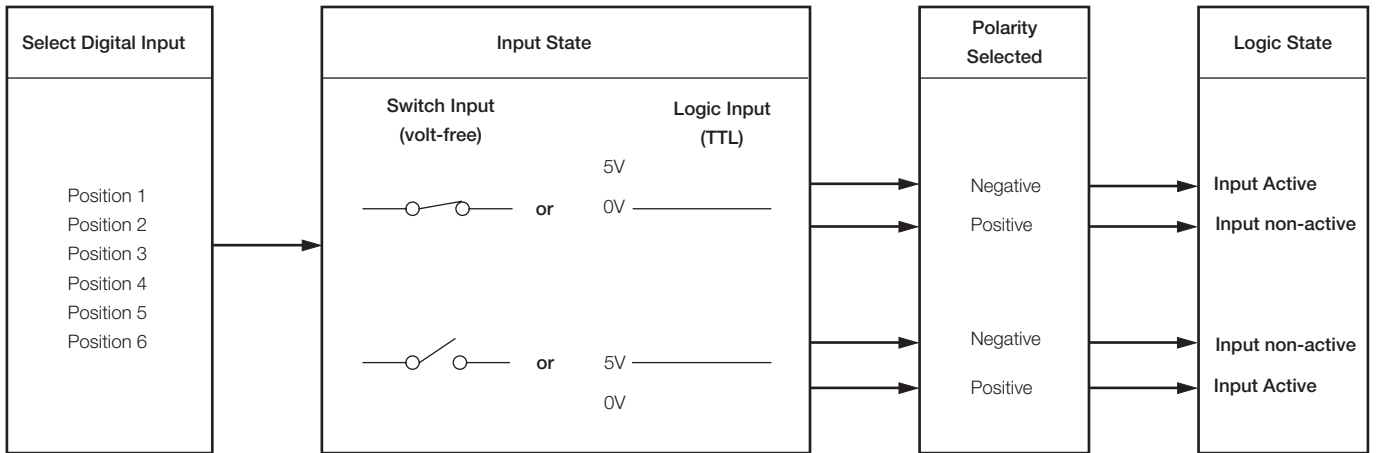

Page Header – Digital Inputs

To advance to **Access Page** press the key.

**Select Digital Input**

Select digital module position to be programmed.

**Note.** In the remaining frames press the key to view the module selected.

**Polarity**

Select the polarity required for the module position selected above:

- POSITIVE* – logic input state unchanged
- NEGATIVE* – logic input state inverted

Return to **Select Digital Input** frame.

3.9 Access Page

Information.

- Configurable password protection – of PROGRAMMING LEVELS.
- Internal security link – enable/disable password protection.

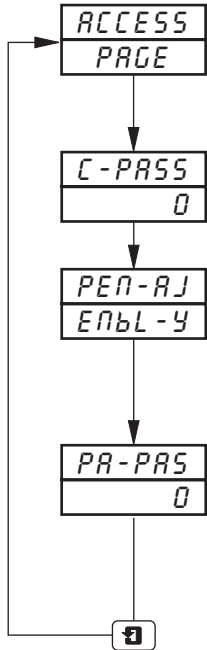

Page Header – Access Page.

To advance to Scale Adjust Page press the key.

**Configuration Password**  
Prevents access to the Programming Pages.

**Pen Adjust Enable**  
Enables / Disables the pen adjustment feature.  
This allows the position of any trend to be adjusted for checking against a reference standard. The displayed value is not changed.

**Pen Adjust Password**  
Prevents access to the pen adjustment.

Set the required password, between 0 and 9999.

Return to top of Access Page.

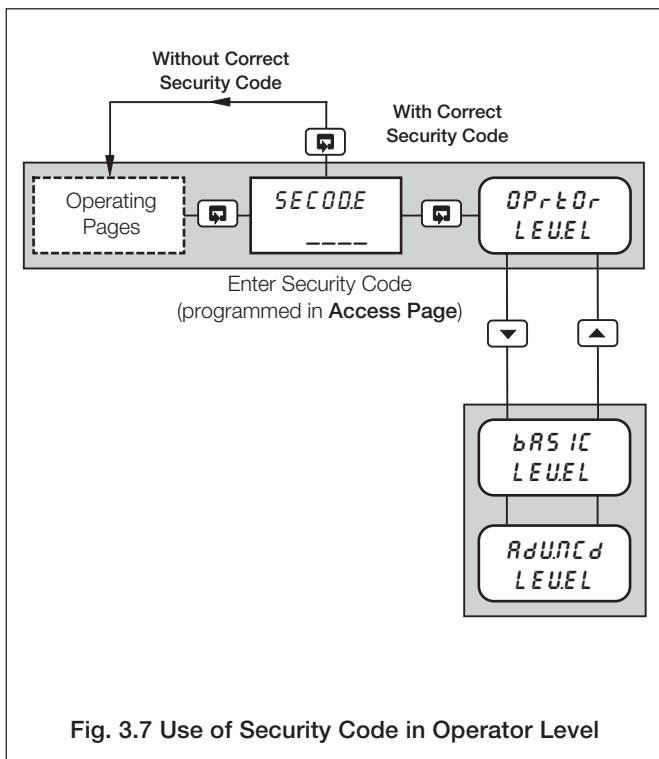

Fig. 3.7 Use of Security Code in Operator Level

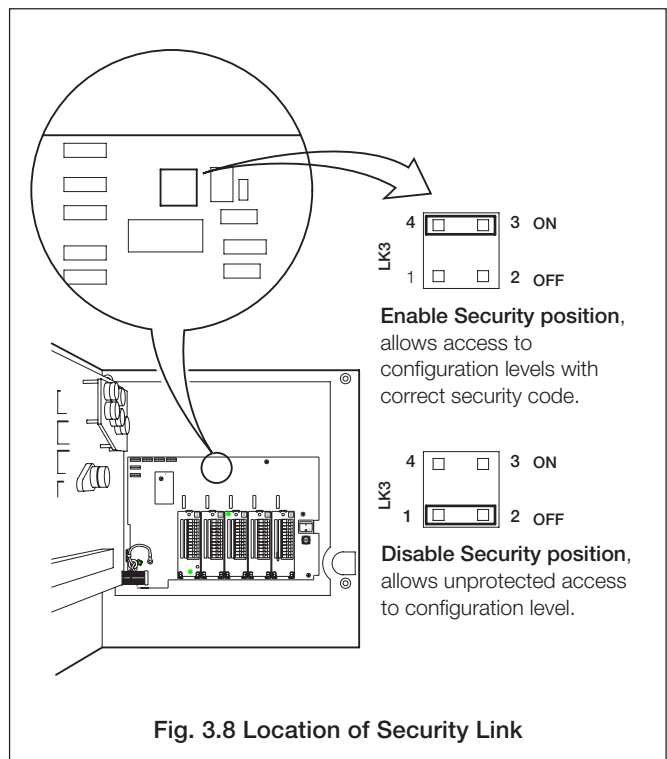

Fig. 3.8 Location of Security Link



## 3.10 Scale Adjust

**Information.**

- **Analog Inputs** – do not require re-calibrating when the input type or range is changed.
- **Process variable adjust reset** – removes any previously programmed offset or scale adjustment settings.
- **System offsets errors** – can be removed using process variable scale offset adjustment.
- **System scale errors** – can be removed using process variable span adjustment.
- **Process variable offset/span adjustment** – can be used to perform spot calibration
- **Pen(s)** – can be independently calibrated and checked across the full range of the chart.
- **Mains filter** – selectable for maximum noise rejection.
- **Pen Linearity Check** – automatically draws a pen linearity test pattern.

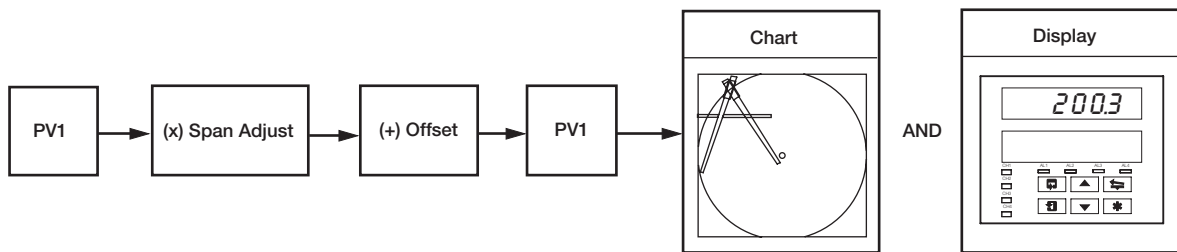
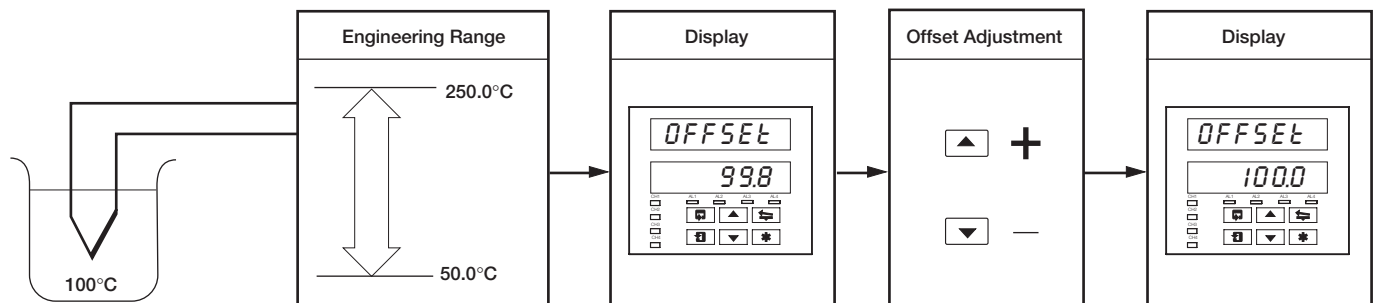
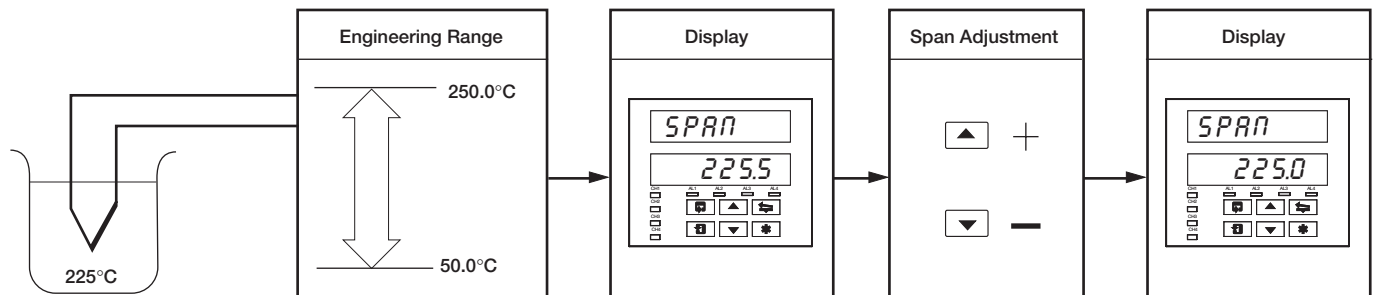
**Scale Adjustment****Offset Adjustment****Span Adjustment****Note.** As a general rule:

- use **Offset** adjustment for spot calibration at <50% of engineering range span.
- use **Span** adjustment for spot calibration at >50% of engineering range span.

...3.10 Scale Adjust

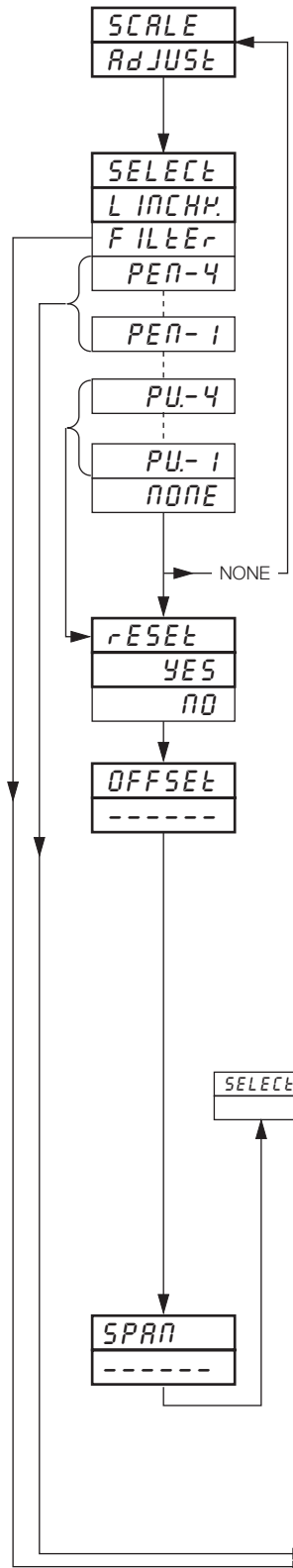

Page Header – **Scale Adjust**

To advance to **BASIC CONFIGURATION LEVEL** frame use the key.

**Select Process Variable/Pen**

Select linearity check, process variable or pen required:

- L INCHP.* – the pens automatically draw a test pattern to check pen linearity. *DONE* is displayed on completion
- F ILtEr* – mains frequency filter
- PEN x* – pens 1 to 4
- PU-4* – process variable on channel 4
- PU-3* – process variable on channel 3
- PU-2* – process variable on channel 2
- PU- 1* – process variable on channel 1
- NONE* – None

**Note.** In the remaining frames press the key to view the process variable or pen selected.

**Process Variable Scale Adjustment Reset**

Set *YES* to reset the process variable offset and span values to their nominal values (values are reset when frame is exited).

**Process Variable Offset Adjustment**

**Electrical and resistance thermometer inputs:** apply the correct input for the spot calibration required.

**RTD inputs:** use resistance values obtained from standard tables.

**Thermocouple Inputs:** measure the ambient temperature at the output terminals of the signal source (calibrator). From thermocouple tables obtain the millivolt equivalent of this temperature (a) and that for the spot calibration temperature (b). Subtract (a) from (b) and set the signal source to the resultant value. (The voltage is negative if the spot calibration temperature is below the measured ambient temperature).

**Note.** The displayed units are engineering units.

Set the value required. The decimal point position is set automatically.

**Example** – If the display range is 50.0 to 250.0 and a spot calibration is required at 100 and 225, inject a signal equivalent to 100 and set the display to 100.0 using the and keys.

**Span Adjust**

Proceed as for **Offset Adjustment** above and apply the correct input for the spot calibration required. The displayed units are engineering units. Set the value required. The decimal point is set automatically.

For the example above, inject a signal equivalent to 225 and set the display to 225.0.

Continued on next page.

## ...3.10 Scale Adjust

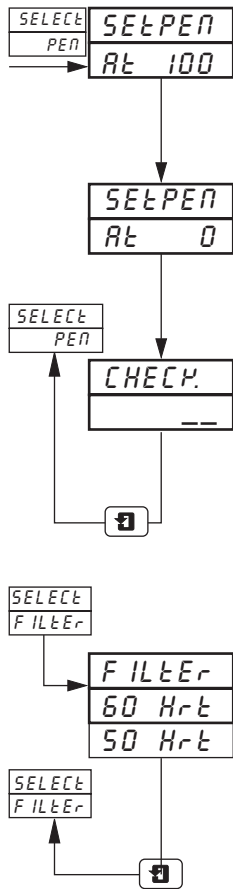
**Calibrate Pen At 100%**

Drives the pen automatically to the full scale position on the chart.

Use the ▲ and ▼ keys to set pen to 100% on the chart.

**Calibrate Pen At 0%**

Drives the pen automatically to the zero position on the chart.

Use the ▲ and ▼ keys to set pen to 0% on the chart.

**Check Pen Calibration**

The pen calibration can be checked at any point on the chart.

Use the ▲ and ▼ keys to move the selected pen from the zero point up to the 100% position on the chart.

**Note.** If the true time event option is fitted the red pen does not move beyond the 94% position on the chart.

**Select Filter**

Select the mains frequency of the supply used to ensure maximum noise rejection on analog inputs.

Return to **Select Process Variable/Pen** frame.

## 4 ADVANCED CONFIGURATION LEVEL

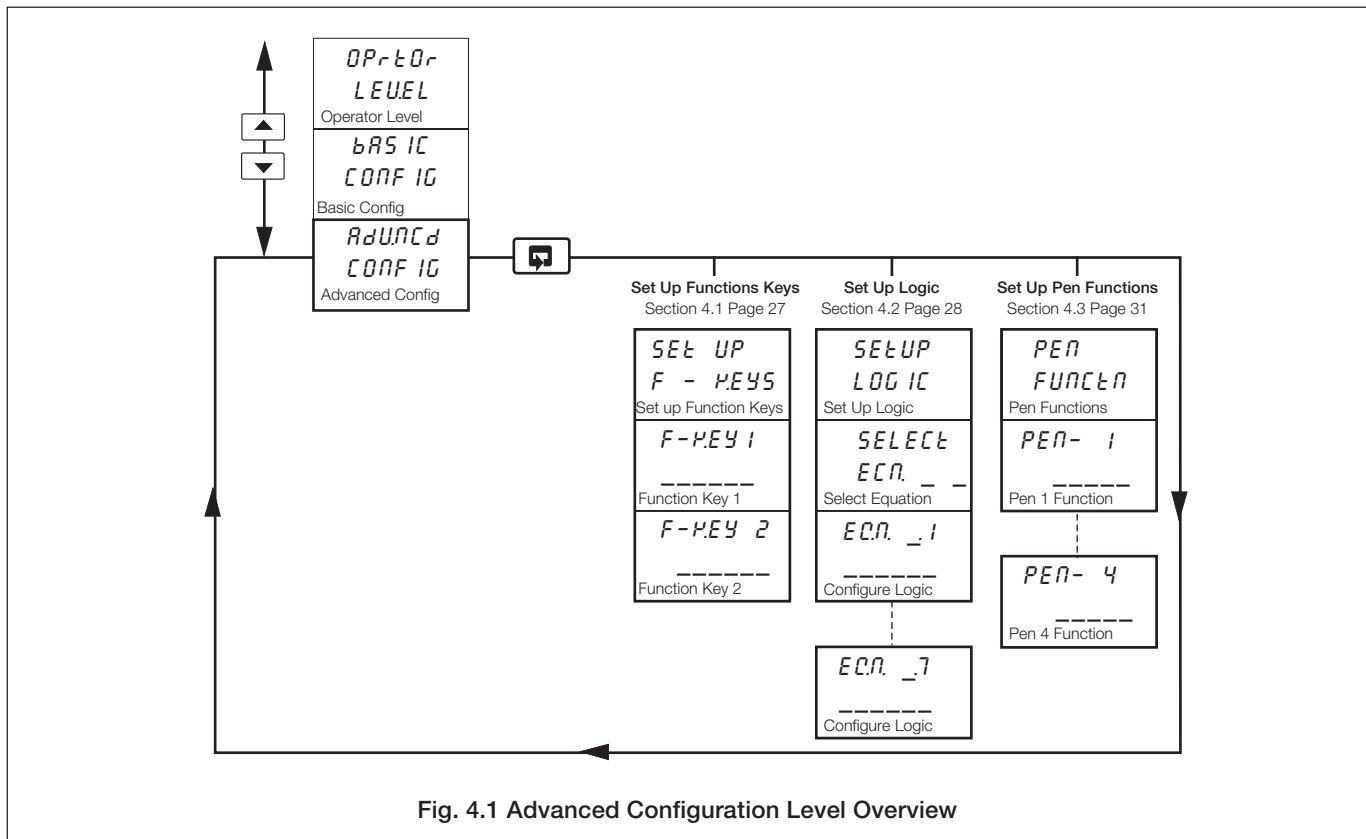
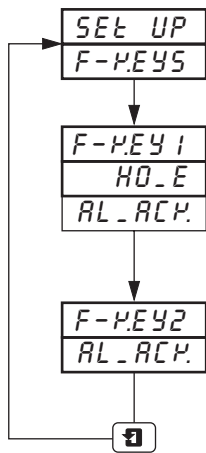

Fig. 4.1 Advanced Configuration Level Overview

## 4.1 Set Up Function Keys

### Information.

- **Programmable function key** – on each faceplate
- **Home function** – returns the instrument display to the start of the operating page when at the top of any page.
- **Global alarm acknowledge function** – acknowledges any unacknowledged alarms on all channels.



### Page Header – Set Up Function Keys

To advance to the **Set Up Logic** press the  key.

### Function Key 1

Select function required.

*HO\_E* – Home (return to **Operating Page** in **OPERATING LEVEL**)

*AL\_ACK.* – Acknowledge alarm

### Function Key 2

Select function required (if applicable).

Return to **Set Up Function Keys** frame.

## 4.2 Set Up Logic

**Information.**

- 4 logic equations
- 7 elements per equation
- OR/AND operators
- **Can combine internal and external digital signals** – i.e. alarms, digital inputs, other logic equation results and real time events (timer option).

For each equation, the logic elements 1 to 7 are arranged sequentially, as shown below. Odd numbered elements are used for logic inputs and even numbered elements for logic gates.

Logic inputs must be set to one of the digital sources listed in Table 3.1 on page 16.

Logic gates must be set to *AND*, *OR* or *END*. Setting an element to *END* terminates the equation.

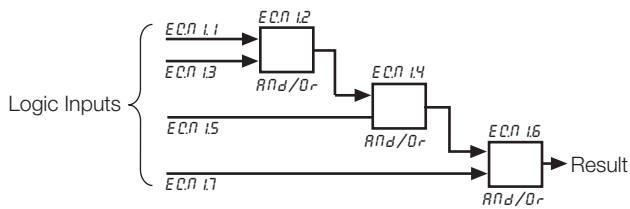

**Note.** Elements on each equation are calculated sequentially, i.e. elements 1, 2 and 3 are evaluated first and this result is then combined with elements 4 and 5. Similarly, this resultant is then combined with elements 6 and 7 to give the logic equation result.

...4.2 Set Up Logic

**Example** – Reservoir level monitoring using:

- process variable 1 with an engineering range 0 to 100 feet
- logic equation 1 result assigned to relay 1.1 which is used to operate the control valve.

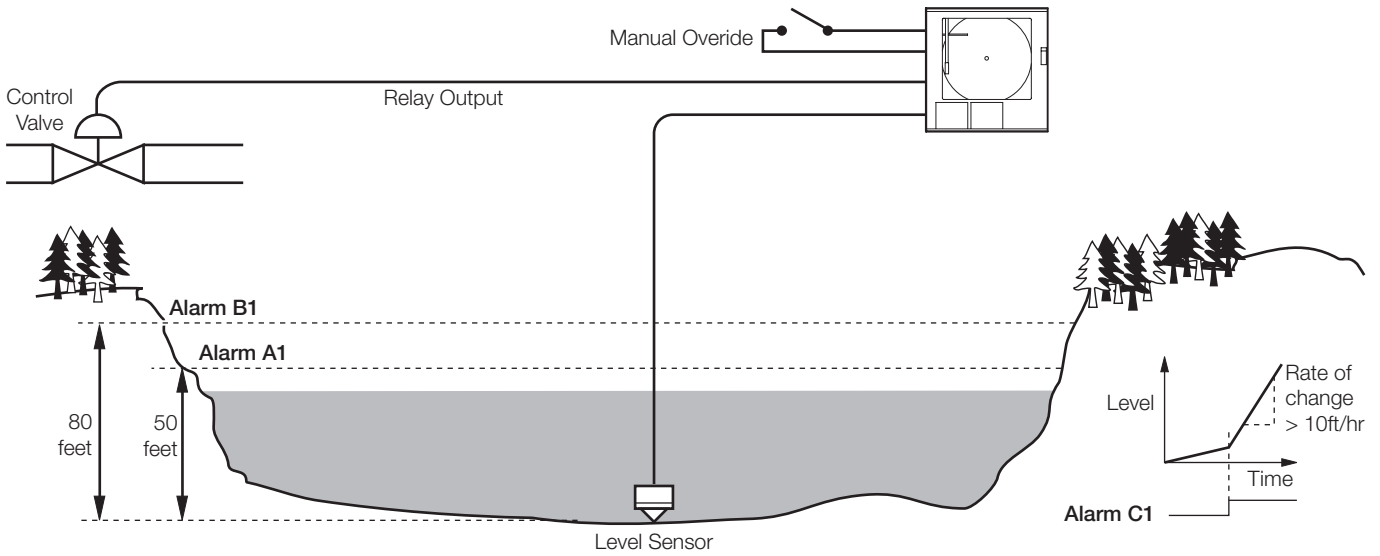

Flow Conditions
Close reservoir control valve if:
<ul style="list-style-type: none"> <li>• Reservoir level &gt;50 feet AND rate of change &gt;10 ft/hr</li> </ul> OR
<ul style="list-style-type: none"> <li>• Reservoir level &gt;80 ft</li> </ul> OR
<ul style="list-style-type: none"> <li>• Manual override switch operated</li> </ul>

Input Elements
<ul style="list-style-type: none"> <li>• <b>Alarm A1</b> – set to high process trip at 50 ft</li> <li>• <b>Alarm B1</b> – set to high process trip at 80 ft</li> <li>• <b>Alarm C1</b> – set to fast rate trip at 10% of range per hour (10 ft/hr)</li> <li>• <b>Manual override switch:</b>                              Connected to digital input 1.1                              Digital input number <u>    </u>                              Module number <u>    </u>                              Negative polarity                              Volt-free switching                         </li> </ul>

Entering the Logic Equation
<i>ECCN 1.1</i> ⇨ <i>RL-R 1</i>
<i>ECCN 1.2</i> ⇨ <i>ANNd</i>
<i>ECCN 1.3</i> ⇨ <i>RL-C 1</i>
<i>ECCN 1.4</i> ⇨ <i>Or</i>
<i>ECCN 1.5</i> ⇨ <i>RL-B 1</i>
<i>ECCN 1.6</i> ⇨ <i>Or</i>
<i>ECCN 1.7</i> ⇨ <i>d 10- 1.1</i>

...4.2 Set Up Logic

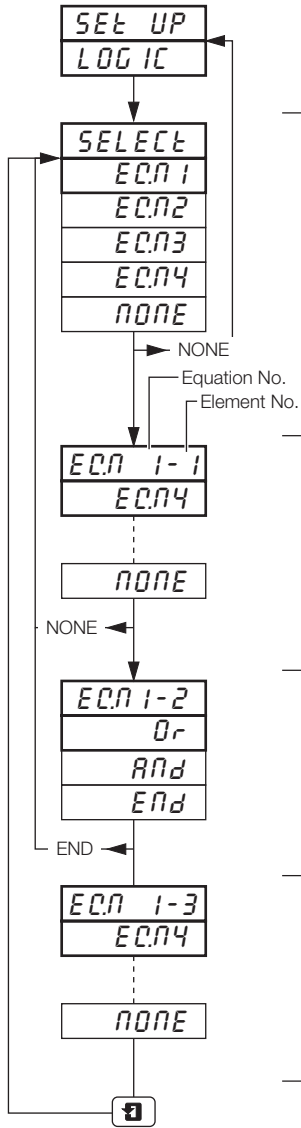

Page Header – Set Up Logic

To advance to **Set Up Pen Functions Page** press the key.

**Select Equation**

Select equation to be constructed.

In the remaining frames press the key to view the equation selected.

**Equation n/Element 1**

Select the source required for element 1.

For a description of sources – see **Table 3.1** on page 16.

**Equation n/Element 2**

Select the operator required to combine elements 1 and 3:

- Or* – Or
- And* – And
- End* – Ends equation

**Equation n/Element 3**

Repeat previous two steps for elements 3 to 7.

Odd numbered elements = sources  
Even numbered elements = operators

Return to **Select Equation** frame.



4.3 Set Up Pen Functions

**Information.** Any fitted pen can be assigned to a trend or an event function.

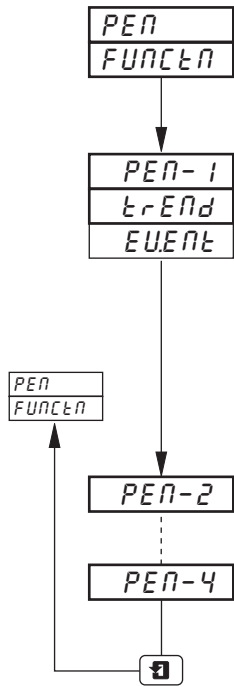

Page Header – Pen Functions

To advance to **Advanced Configuration** frame press the key.

**Pen 1**

Select pen function required:

- TREND* – Trend pen
- EVENT* – Event pen

**Note.** The event pen and true time line event pen are separate functions and only the event pen can be selected in this page. The true time line event pen option allows event marking on the same time line as the red pen and requires a special pen arm and motor assembly. Refer to the order code in the **Specification Sheet**.

**Pen 2 to 4**

Repeat as for **Pen 1** (if applicable).

Return to top of **Set Up Pen Functions Page**.

## Main Input, Standard Input & Analog + Relay

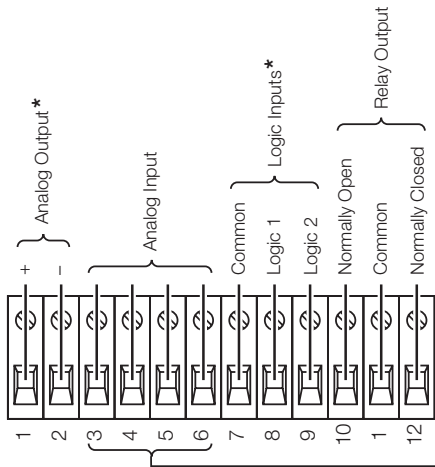

\* Not fitted on Analog + Relay Module

## 4 Relays Module

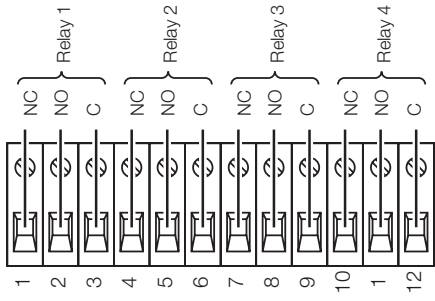

## 8 Digital Inputs/Outputs Module

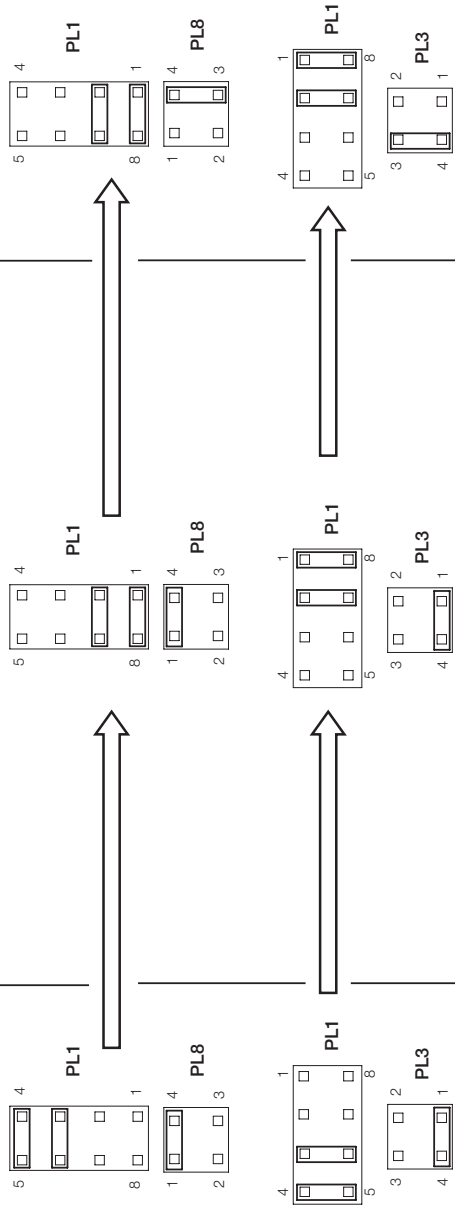
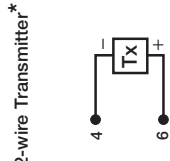
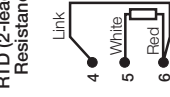
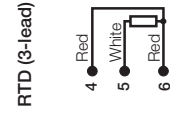
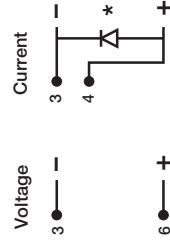
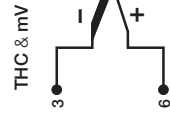
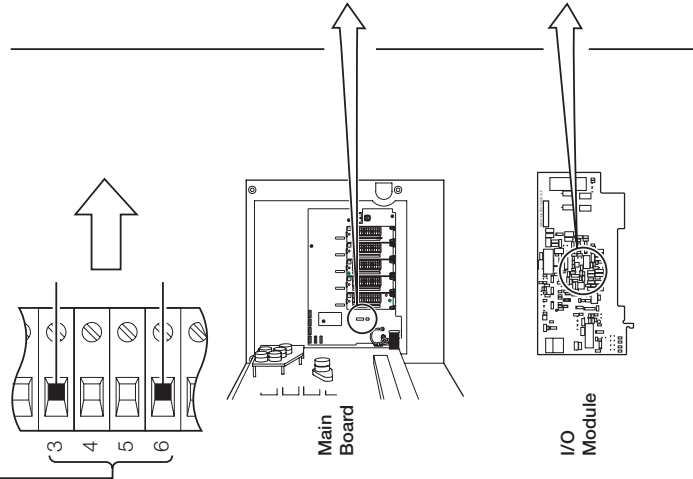
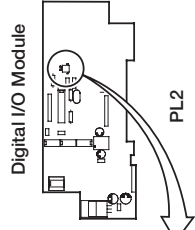
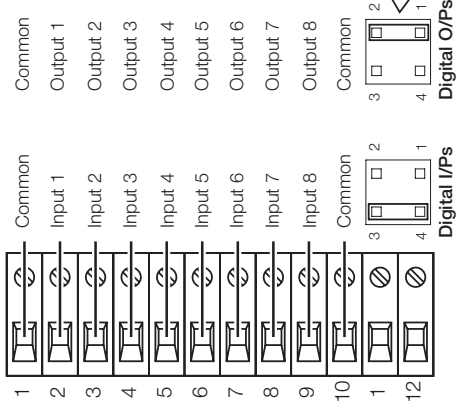

\* Recommended diode: Diode forward voltage > 0.8 V @ 20 mA or use 2 x 1N4001 general purpose diodes in series.

# Products and customer support

## Automation Systems

For the following industries:

- Chemical & Pharmaceutical
- Food & Beverage
- Manufacturing
- Metals and Minerals
- Oil, Gas & Petrochemical
- Pulp and Paper

## Drives and Motors

- AC and DC Drives, AC and DC Machines, AC Motors to 1kV
- Drive Systems
- Force Measurement
- Servo Drives

## Controllers & Recorders

- Single and Multi-loop Controllers
- Circular Chart and Strip Chart Recorders
- Paperless Recorders
- Process Indicators

## Flexible Automation

- Industrial Robots and Robot Systems

## Flow Measurement

- Electromagnetic Flowmeters
- Mass Flowmeters
- Turbine Flowmeters
- Wedge Flow Elements

## Marine Systems & Turbochargers

- Electrical Systems
- Marine Equipment
- Offshore Retrofit and Refurbishment

## Process Analytics

- Process Gas Analysis
- Systems Integration

## Transmitters

- Pressure
- Temperature
- Level
- Interface Modules

## Valves, Actuators and Positioners

- Control Valves
- Actuators
- Positioners

## Water, Gas & Industrial Analytics Instrumentation

- pH, Conductivity and Dissolved Oxygen Transmitters and Sensors
- Ammonia, Nitrate, Phosphate, Silica, Sodium, Chloride, Fluoride, Dissolved Oxygen and Hydrazine Analyzers
- Zirconia Oxygen Analyzers, Katharometers, Hydrogen Purity and Purge-gas Monitors, Thermal Conductivity

## Customer support

We provide a comprehensive after sales service via a Worldwide Service Organization. Contact one of the following offices for details on your nearest Service and Repair Centre.

### UK

ABB Limited  
Tel: +44 (0)1453 826661  
Fax: +44 (0)1453 829671

### USA

ABB Inc.  
Tel: +1 215 674 6000  
Fax: +1 215 674 7183

### Client Warranty

Prior to installation, the equipment referred to in this manual must be stored in a clean, dry environment, in accordance with the Company's published specification. Periodic checks must be made on the equipment's condition. In the event of a failure under warranty, the following documentation must be provided as substantiation:

- A listing evidencing process operation and alarm logs at time of failure.
- Copies of all storage, installation, operating and maintenance records relating to the alleged faulty unit.

# Contact us

To find your local ABB contact visit:

[www.abb.com/contacts](http://www.abb.com/contacts)

For more product information visit:

[www.abb.com](http://www.abb.com)

## Note

We reserve the right to make technical changes or modify the contents of this document without prior notice. With regard to purchase orders, the agreed particulars shall prevail. ABB does not accept any responsibility whatsoever for potential errors or possible lack of information in this document.

We reserve all rights in this document and in the subject matter and illustrations contained therein. Any reproduction, disclosure to third parties or utilization of its contents in whole or in parts - is forbidden without prior written consent of ABB.

Copyright© 2010 ABB

All rights reserved

IM/C1900-PGR Rev. K 06.2010