

C1900 Series Circular Chart Recorder / Controllers

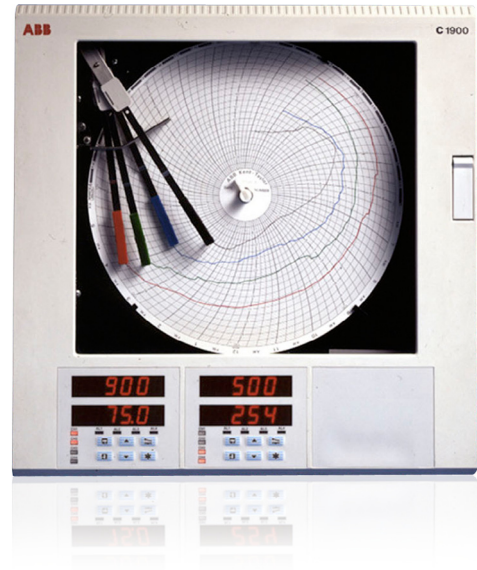

The Company

We are an established world force in the design and manufacture of measurement products for industrial process control, flow measurement, gas and liquid analysis and environmental applications.

As a part of ABB, a world leader in process automation technology, we offer customers application expertise, service and support worldwide.

We are committed to teamwork, high quality manufacturing, advanced technology and unrivalled service and support.

The quality, accuracy and performance of the Company's products result from over 100 years experience, combined with a continuous program of innovative design and development to incorporate the latest technology.

EN ISO 9001:2000



Cert. No. Q 05907

EN 29001 (ISO 9001)



Lenno, Italy – Cert. No. 9/90A

Stonehouse, U.K.



Electrical Safety

This equipment complies with the requirements of CEI/IEC 61010-1:2001-2 'Safety Requirements for Electrical Equipment for Measurement, Control and Laboratory Use'. If the equipment is used in a manner NOT specified by the Company, the protection provided by the equipment may be impaired.

Symbols

One or more of the following symbols may appear on the equipment labelling:

	Warning – Refer to the manual for instructions
	Caution – Risk of electric shock
	Protective earth (ground) terminal
	Earth (ground) terminal

	Direct current supply only
	Alternating current supply only
	Both direct and alternating current supply
	The equipment is protected through double insulation

Information in this manual is intended only to assist our customers in the efficient operation of our equipment. Use of this manual for any other purpose is specifically prohibited and its contents are not to be reproduced in full or part without prior approval of the Technical Publications Department.

Health and Safety

To ensure that our products are safe and without risk to health, the following points must be noted:

1. The relevant sections of these instructions must be read carefully before proceeding.
2. Warning labels on containers and packages must be observed.
3. Installation, operation, maintenance and servicing must only be carried out by suitably trained personnel and in accordance with the information given.
4. Normal safety precautions must be taken to avoid the possibility of an accident occurring when operating in conditions of high pressure and/or temperature.
5. Chemicals must be stored away from heat, protected from temperature extremes and powders kept dry. Normal safe handling procedures must be used.
6. When disposing of chemicals ensure that no two chemicals are mixed.

Safety advice concerning the use of the equipment described in this manual or any relevant hazard data sheets (where applicable) may be obtained from the Company address on the back cover, together with servicing and spares information.

CONTENTS

Section	Page
1 INTRODUCTION	1
2 GENERAL PROGRAMMING	2
2.1 Preparation for Changes to the Parameters	2
2.2 Security System	2
3 BASIC CONFIGURATION LEVEL	3
3.1 Set Up Input (Process Variable, Remote Set Point and Position Feedback)	4
3.2 Set Up Pen Range/Event Source	8
3.3 Set Up Chart	9
3.4 Set Up Alarms	10
3.5 Set Up Relay Output	16
3.6 Set Up Digital Output	19
3.7 Set Up Analog Output	21
3.8 Digital Inputs	23
3.9 Access Page	24
3.10 Scale Adjust	26
4 CONTROL CONFIGURATION LEVEL	29
4.1 Set Points	30
4.1.1 Cascade Control (without output tracking)	31
4.1.2 Cascade Control (with output tracking)	32
4.1.3 Set Points Page	33
4.2 Motorized Valve Control	35
4.2.1 Motorized Valve with Feedback (Position-Proportioning)	35
4.2.2 Motorized Valve Control without Feedback (Boundless)	35
4.2.3 Valve Page	36
4.2.4 Calculation for Control Pulses, Steps and Deviation (Boundless Control only)	36
4.3 Set Up Control	37
4.3.1 Set Up Control Page (control type)	37
4.3.2 Set Up Control Page (power-fail mode)	39
4.3.3 Set Up Control Page (control actions and limits – non heat/cool)	41
4.3.4 Set Up Control Page (control actions and limits – heat/cool)	42
4.3.5 Set Up Control Page (default control actions)	43
4.4 Set Up Operating Page	45
4.5 Set Up Digital Page	46
4.6 Set Up Digital Inputs	47
5 ADVANCED CONFIGURATION LEVEL	48
5.1 Set Up Function Keys	49
5.2 Set Up Logic	50
5.3 Set Up Pen Functions	52
5.4 Input Assignment	53
6 CONNECTIONS & LINKS	54

1 INTRODUCTION

The documentation for the C1900 series of circular chart recorders is shown in Fig. 1.1. The **Standard Manuals**, including the data sheet, are supplied with all instruments. The **Supplementary Manuals** supplied depend on the specification of the instrument.

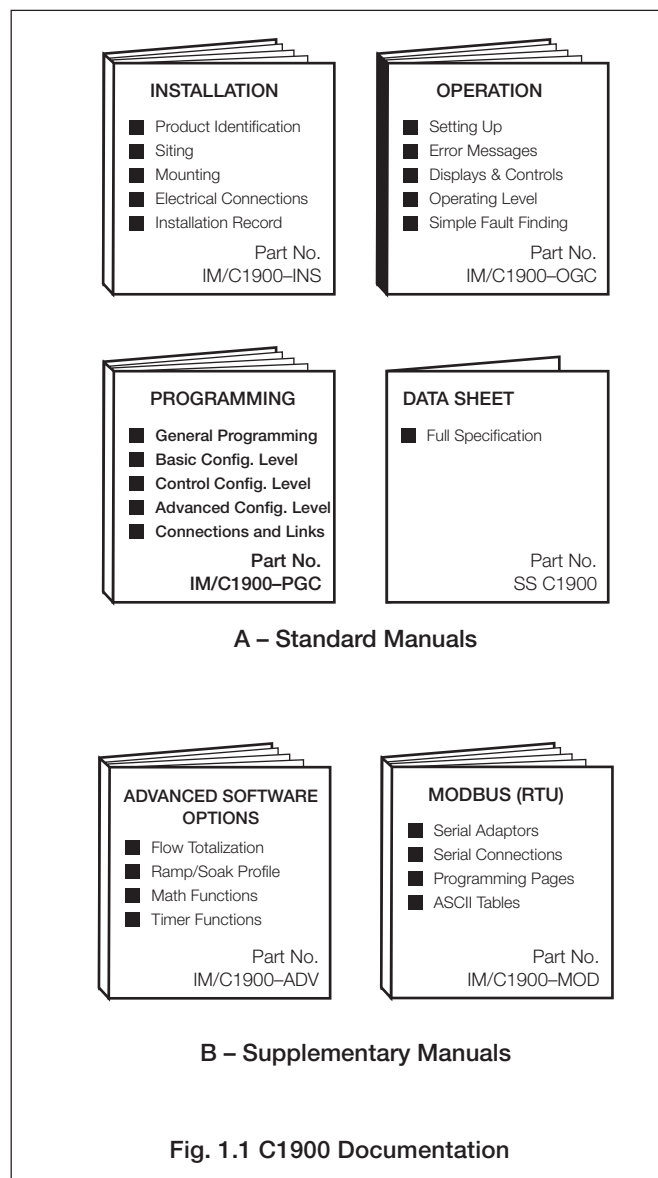

Fig. 1.1 C1900 Documentation

2 GENERAL PROGRAMMING

The programming procedures are used to make changes to the operating parameter values and for scale adjustment.

The programming of all channels is performed using faceplate 1 – see Fig. 2.1

When changing the input type it may be necessary to reposition the input selector links accordingly – see Section 6, **CONNECTIONS & LINKS**.

2.1 Preparation for Changes to the Parameters

Ensure that the external alarm/control circuits are isolated if inadvertent operation during programming is undesirable.

Any change to the operating parameters are implemented using the ▲ or ▼ keys – see Section 3 of the **Operating Guide**.

Note. The recorder responds instantly to parameter changes which are saved automatically when leaving the current frame.

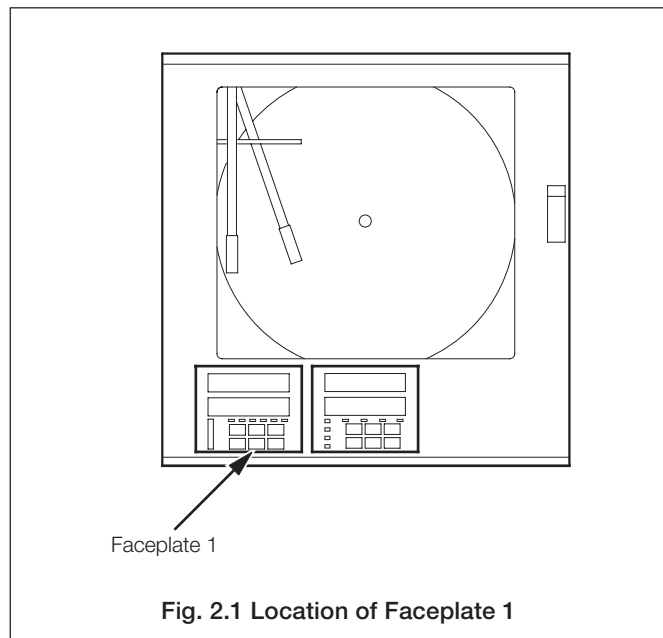

Fig. 2.1 Location of Faceplate 1

2.2 Security System

A security system is used to prevent tampering with the programmed parameters by utilizing a Tune password and a Configuration password.

A Tune password can be assigned to controller faceplates giving access to that faceplate's controller settings. A configuration password gives access to all controller settings and programming pages. The passwords can be set to any value from 0 to 9999. The instrument is despatched with the passwords set to '0' – see Section 5.5 of the **Operating Guide**.

3 BASIC CONFIGURATION LEVEL

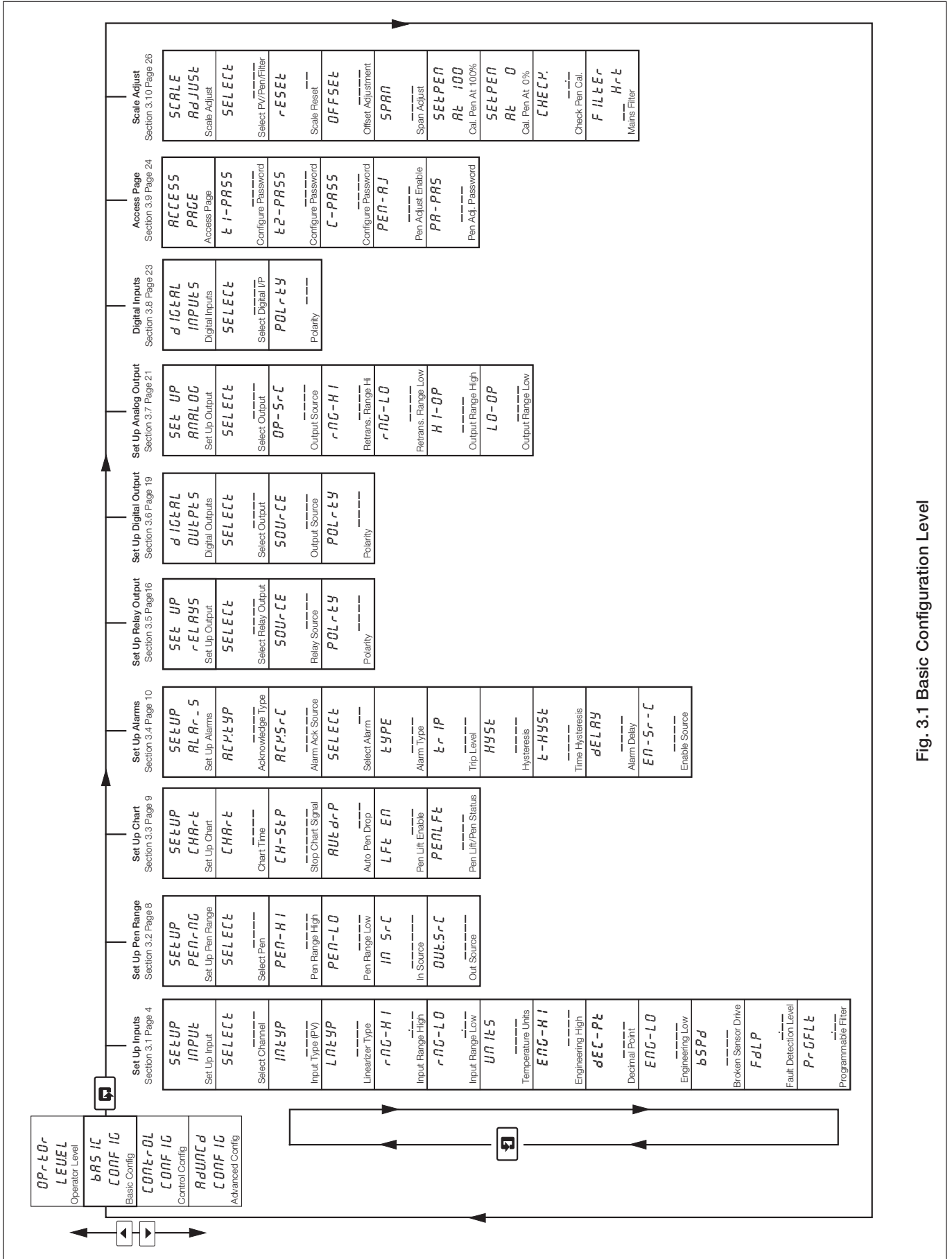

Fig. 3.1 Basic Configuration Level

...3 BASIC CONFIGURATION LEVEL

3.1 Set Up Input (Process Variable, Remote Set Point and Position Feedback)

Information.

- **Universal inputs** – mV, mA, V, THC, RTD and resistance.
- **Internal cold junction compensation.**
- **Linearization** – of temperature sensors to allow use of non-linearizing transmitters or any electrical input.
- **Programmable fault levels and actions.**
- **Digital filter** – reduces the effect of noise on inputs.

Example A – setting up:

- a current input of 4 to 20mA
- displaying a range of 0 to 200psi
- a fault detection level 10% above 200psi (engineering/display range) and 10% below 0psi (engineering/display range)
- in the event of a fault being detected and/or the fault detection level being exceeded the process variable is driven downscale.

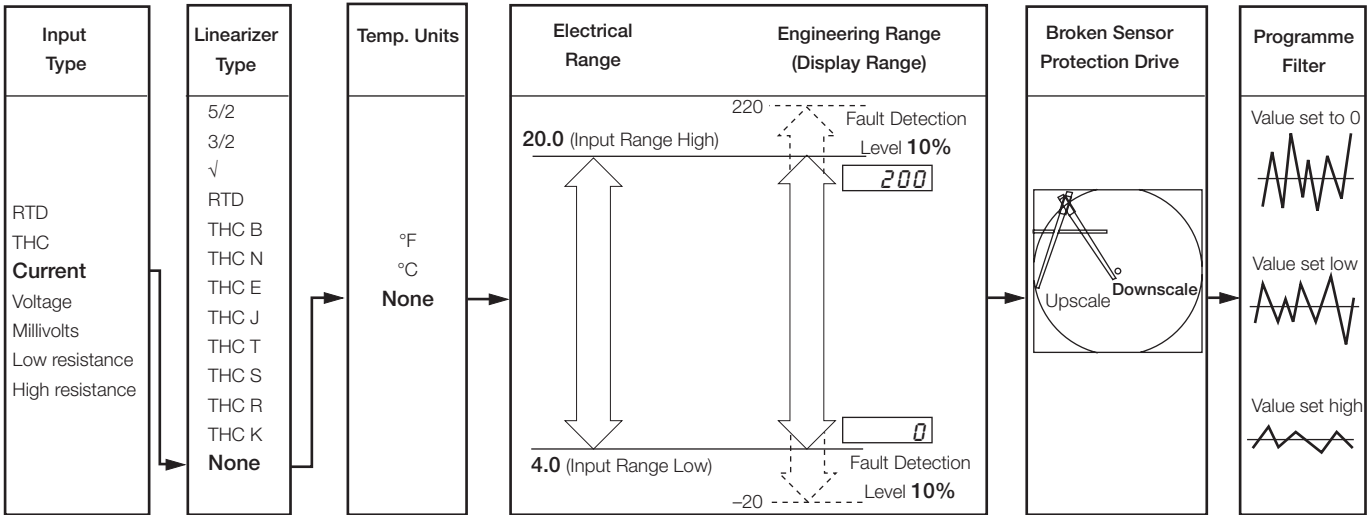

Example B – setting up:

- a Type K thermocouple
- displaying temperature in °F
- displaying a range of 0 to 2000°F
- a fault detection level 10% above 2000°F (engineering/display range) and 10% below 0°F (engineering/display range)
- in the event of a fault being detected and/or the fault detection level being exceeded the process variable is driven upscale.

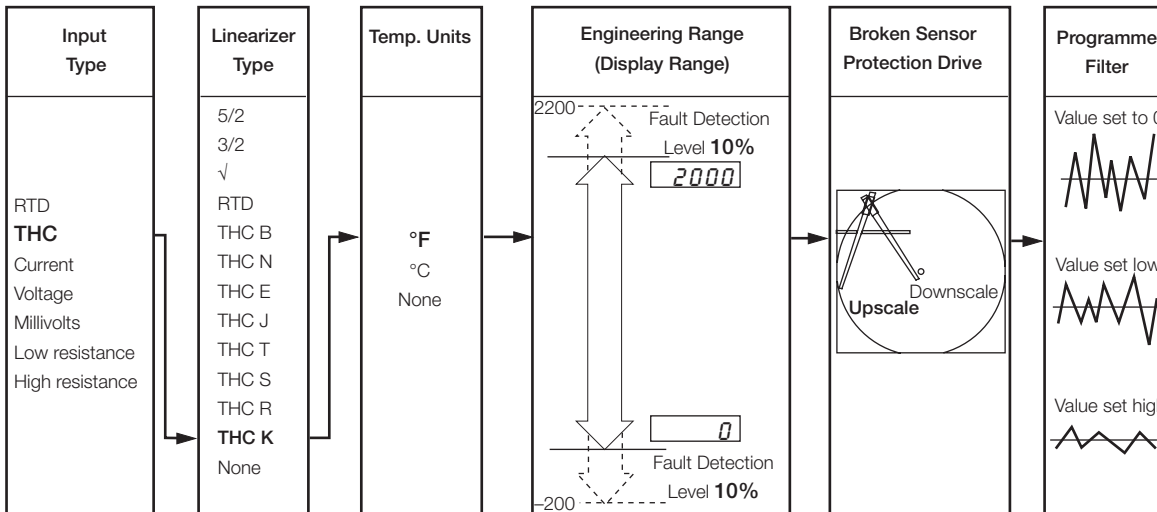

...3.1 Set Up Input

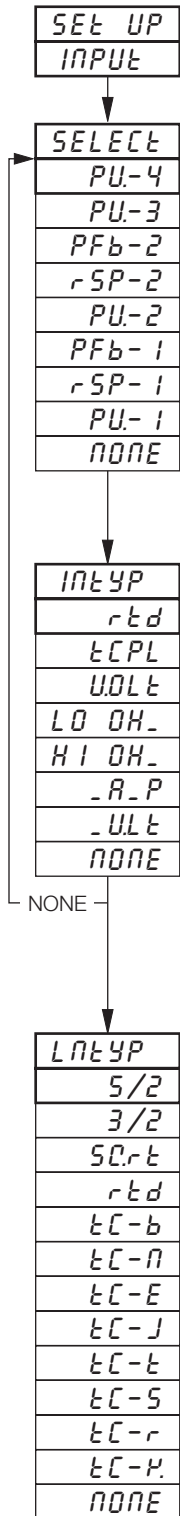

Page Header – Set Up Input (Process Variable)

To advance to Set Up Pen Range Page press the key.

Select Channel

Select the channel to be programmed:

- PU-4 – process variable on channel 4
 - PU-3 – process variable on channel 3
 - PFb-2 – valve position feedback on controller 2
 - rSP-2 – remote set point on controller 2
 - PU-2 – process variable on channel 2
 - PFb-1 – valve position feedback on controller 1
 - rSP-1 – remote set point on controller 1
 - PU-1 – process variable on channel 1
 - NONE – None
- } displayed only if selected in the Input Assignment Page

Note. In the remaining frames press the key to view the channel selected.

Input Type (Process Variable)

Caution. Ensure the correct input link positions are selected and the input is wired correctly – see Section 6, CONNECTIONS & LINKS.

Select the input type required:

- rtd – Resistance thermometer
 - tCPL – Thermocouple
 - UOLt – Voltage
 - LO OH_ – Low resistance ($\leq 750\Omega$)
 - HI OH_ – High resistance ($> 750\Omega$)
 - _R_P – Current
 - _ULt – Millivolt ($\leq 150\text{mV}$)
 - NONE – None
- } Not available on position feedback input

Linearizer Type

Select the linearizer type required:

- 5/2 – $x^{5/2}$
 - 3/2 – $x^{3/2}$
 - SQRt – Square Root
 - rtd – Resistance thermometer
 - tC-b – Type B thermocouple
 - tC-n – Type N thermocouple
 - tC-E – Type E thermocouple
 - tC-J – Type J thermocouple
 - tC-t – Type T thermocouple
 - tC-S – Type S thermocouple
 - tC-r – Type R thermocouple
 - tC-K – Type K thermocouple
 - NONE – No linearizer
- } Open channel flow applications

Continued on next page.

...3 BASIC CONFIGURATION LEVEL

...3.1 Set Up Input

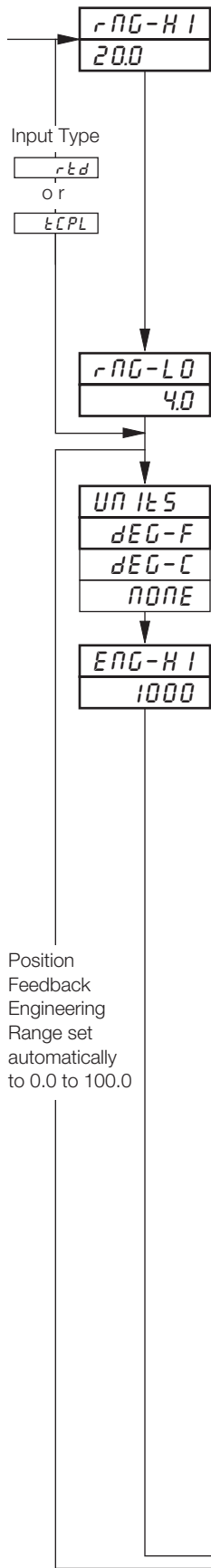

Input Range High

Set the maximum electrical input value required (in electrical units).

Note. The value set must be within the limits detailed in the table below.

Input Type	Range Low Min.	Range High Max.	Min. Range (Low to High)
Millivolts	0	150	5.0
Volts	0	5	0.1
Milliamps	0	50	1.0
Resistance Low	0	750	20
Resistance High	0	9999	400

Input Range Low

Set the minimum electrical input value required (in electrical units).

Note. The value set must be within the limits detailed in the above table.

Temperature Units

Select units required.

Engineering Range High

Set the maximum engineering (display) value required.

Note. The value set must be within the limits detailed in the tables below.

Linearizer Type	Degrees Fahrenheit			Degrees Celsius		
	Min.	Max.	Min. Span	Min.	Max.	Min. Span
Type B	0	3272	1278	-18	1800	710
Type E	-148	1652	81	-100	900	45
Type J	-148	1652	90	-100	900	50
Type K	-148	2372	117	-100	1300	65
Type N	-328	2372	162	-200	1300	90
Type R & S	0	3092	576	-18	1700	320
Type T	-418	572	108	-250	300	60
RTD	-328	1112	45	-200	600	25

Performance accuracy is not guaranteed below 725°F/400°C for types B, R and S thermocouples

Minimum span below zero Type T 126°F/70°C

Minimum span below zero type N 189°F/105°C

THC standard DIN 4730 IEC 584

RTD standard DIN 43760 IEC 751

Linearizer Type	Engineering Range High and Low	
	Min.	Max.
5/2	-9999	+9999
3/2		
Square Root		
None		

Continued on next page.

...3.1 Set Up Input

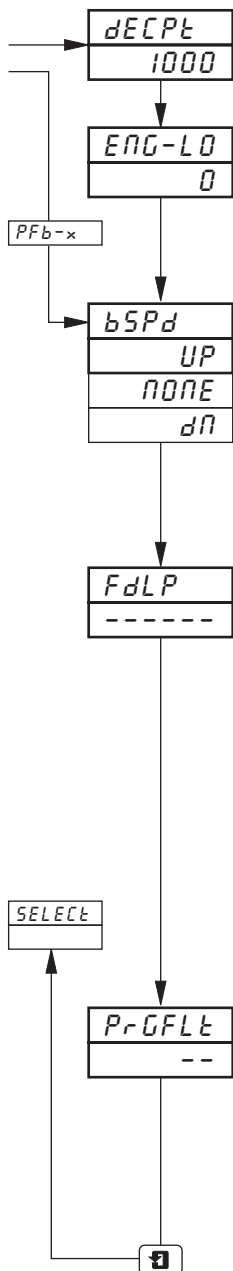
**Decimal Point**

Set the decimal point position required for **both** the engineering range high and engineering range low values.

Engineering Range Low

Set the minimum engineering (display) value required,

Note. The value set must be within the limits detailed in **Engineering Range High** tables opposite.

Broken Sensor Protection Drive

In the event of a fault being detected on the input and/or if the **Fault Detection Level Percentage** is exceeded (see next frame), the process variable is driven in the direction of the drive selected.

Select the broken sensor drive required:

- NONE* – No drive
- UP* – Upscale drive
- dN* – Downscale drive.

Fault Detection Level Percentage

A fault level percentage can be set to detect a deviation above or below the display limits.

For example, if *FdLP* is set at 10.0%, a fault is detected if an input goes more than 10% above **Engineering Range High** or more than 10% below **Engineering Range Low**.

On some ranges the input circuitry may saturate before the fault level set is reached. In this case an error is detected below the level set.

Set the level required, between 0.0 and 100.0% of engineering span (range low to high) in 0.1% increments.

Note. If an input exceeds the minimum or maximum value for the linearizer selected an error is detected regardless of any fault level.

Programmable Filter

Filters the process variable input, i.e. if the input is stepped it smooths the transition between steps and may also be used for some degree of cleaning of noisy inputs. The filter time represents the time a step in the input takes to change the displayed process variable from 10 to 90% of the step.

Set the value required, between 0 and 60 in 1 second increments.

Return to **Select Channel** frame.

3.2 Set Up Pen Range/Event Source

Information.

- **Trend pens** – have an independent chart range allowing a selected part of the engineering (display) range to be used for extra resolution on the chart.
- **Three position event pen function** – can be driven by digital inputs, alarms, logic equation results, real time events (timer option), control modes, set points, ramp/soak profile segments or programs (profile option).

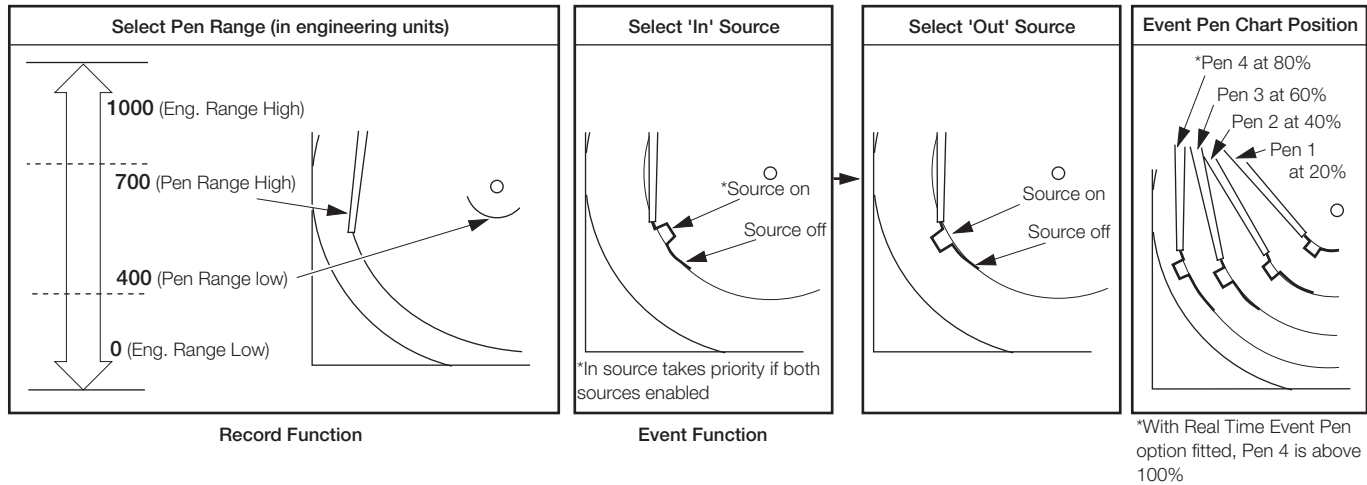

*With Real Time Event Pen option fitted, Pen 4 is above 100%

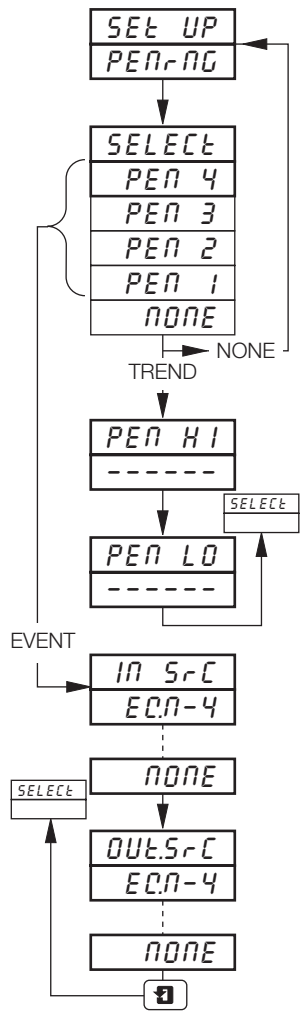

Page Header – Set Up Pen Range

To advance to **Set Up Chart Page** press the key.

Select Pen

Select the pen to be programmed

Note.

- In the remaining frames press the key to view the pen selected.
- Record (trend) or event pen function is set in the **ADVANCED CONFIGURATION LEVEL** (if True Time Event Pen option is selected, the fourth pen is fitted with a special pen arm and is set automatically for event pen function) – see Section 4.3, **Set Up Pen Functions**.

Pen Range High

Set the maximum value required on the chart, in engineering units (the value must be within the engineering range set in **Set Up Input Page** – see Section 3.1).

Pen Range Low

Set the minimum value required on the chart, in engineering units (the value must be within the engineering range set in **Set Up Input Page**).

In Source

Select a source to move the pen inwards on the chart.

For a description of sources – see **Table 3.1** on page 18.

Out Source

Select a source to move the pen outwards on the chart.

For a description of sources – see **Table 3.1** on page 18.

Return to **Select Pen** frame.

3.3 Set Up Chart

Information.

- **Programmable chart duration** – between 1 and 167 hours or 7 and 32 days.
- **Chart stop function** – the chart can be stopped by an alarm, digital input, logic equation result or a real time event (if timer option is fitted).
- **Auto pen drop** – automatically drops the pen(s) onto the chart after a 5 minute delay to ensure recording is not left disabled inadvertently

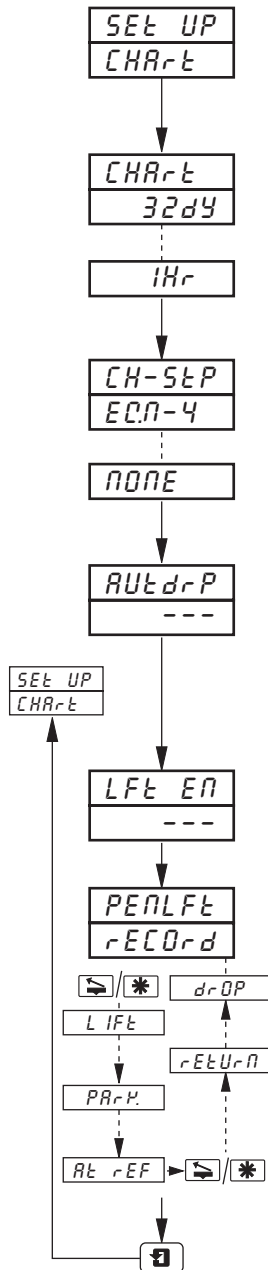

Page Header – **Set Up Chart**

To advance to **Set Up Alarms Page** press the key.

Chart Duration

Select the chart duration required per revolution of the chart; between 1 and 167 hours or 7 and 32 days.

Stop Chart Source

Select the source required for stopping the chart.

For description of sources, refer to **Table 3.1** on page 18.

Auto Pen Drop

Select 'YES' to enable or 'NO' to disable.

If 'YES' selected, pen(s) drop automatically onto the chart 5 minutes after they are lifted.
If 'NO' selected, the pen(s) remain lifted until they are manually dropped by the operator.

Pen Lift Enable/Disable

The key (record faceplate only) or key (control faceplate – if programmed for pen lift) can be disabled if required. Select 'YES' to enable or 'NO' to disable.

Pen Lift/Pen Status

To raise pen(s) press or key. The following status displays are shown:

- rECOrd – pen records on chart
- LIFT – pen lifts off chart
- PARK – pen moves to park position
- RETURN – pen at reference position

To lower pen(s) press or key. The following status displays are shown:

- RETURN – pen returns to record position
- DROP – drops (lowers) onto chart
- rECOrd – pen records on chart

Return to top of **Set Up Chart Page**.

3.4 Set Up Alarms

Information.

- **Four alarms per channel** – identified A1 to D1 (for channel 1) up to A4 to D4 (for channel 4).
- **Three operator acknowledge options.**
- **Global alarm acknowledgment** – by digital input, alarm, logic equation result or real time event (if option fitted).
- **High/low process alarms.**
- **Delayed high/low process alarms.**
- **High/low output alarms.**
- **High/low deviation alarms.**
- **Fast/slow rate of change** – of process variable alarms.
- **Adjustable hysteresis value** – to prevent oscillation of alarm state.
- **Time hysteresis** – to allow delayed triggering of alarms.

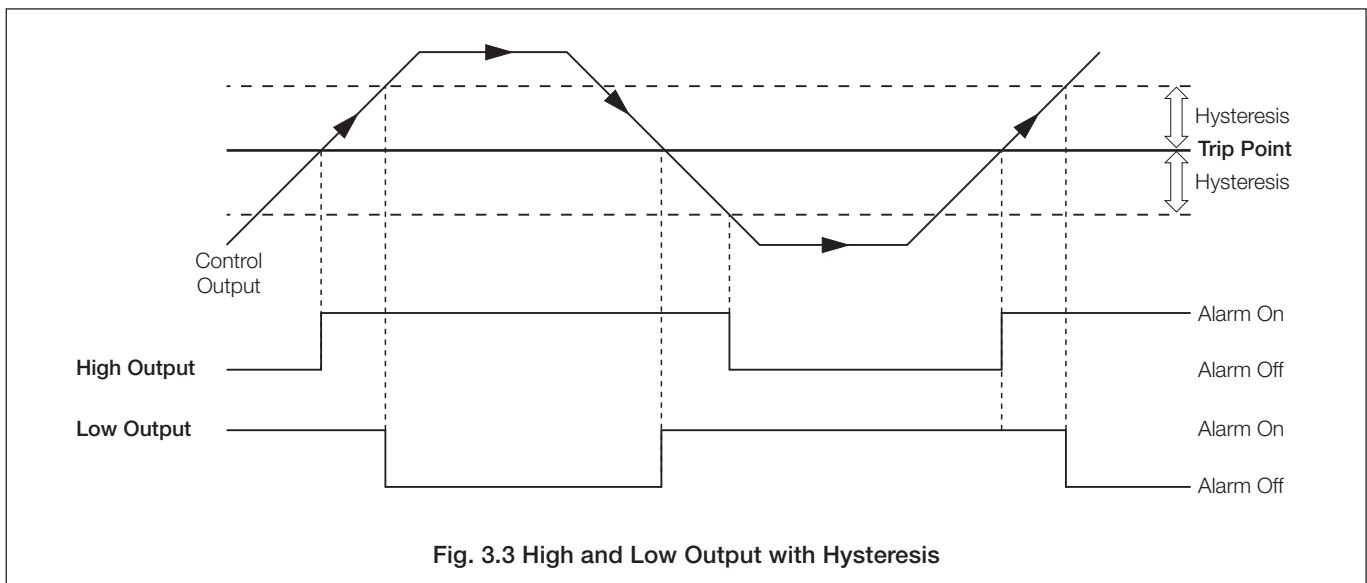
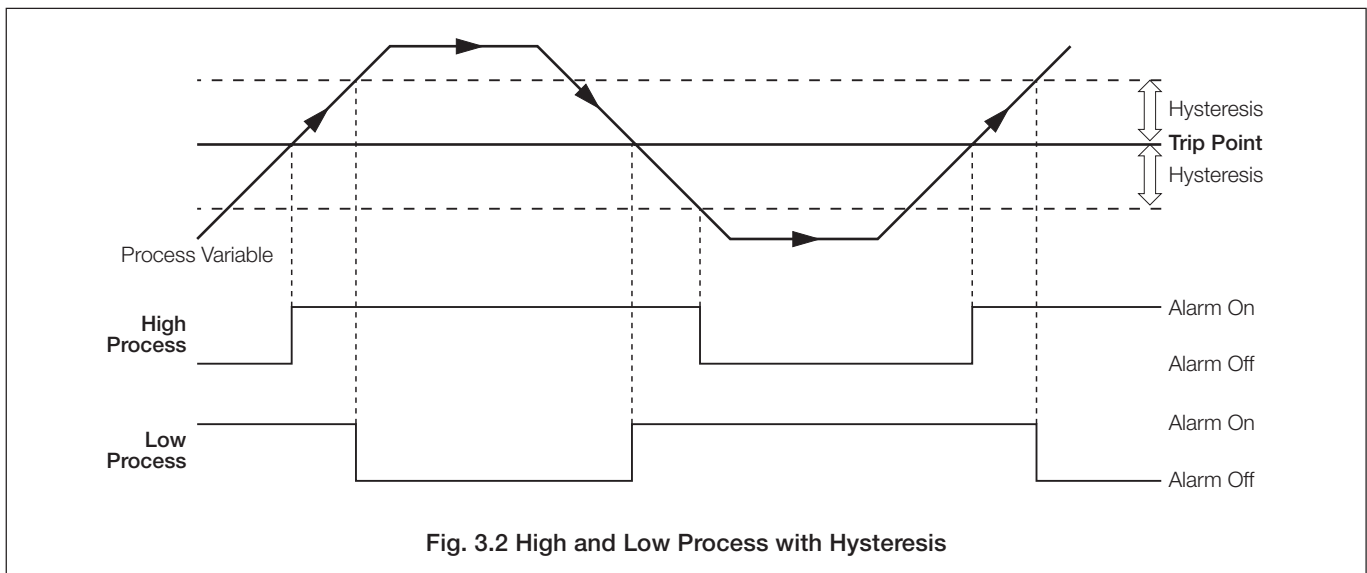

...3.4 Set Up Alarms

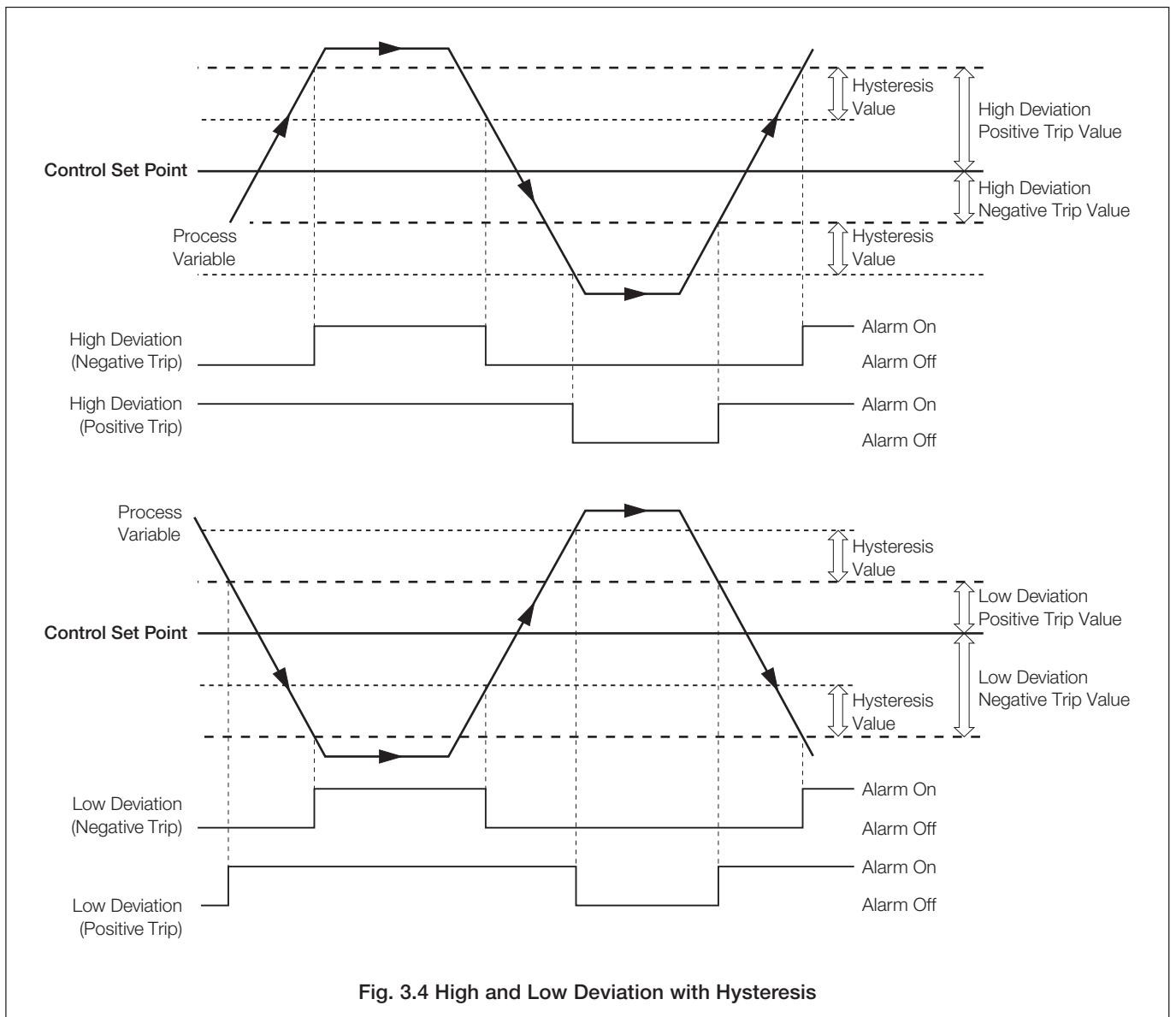
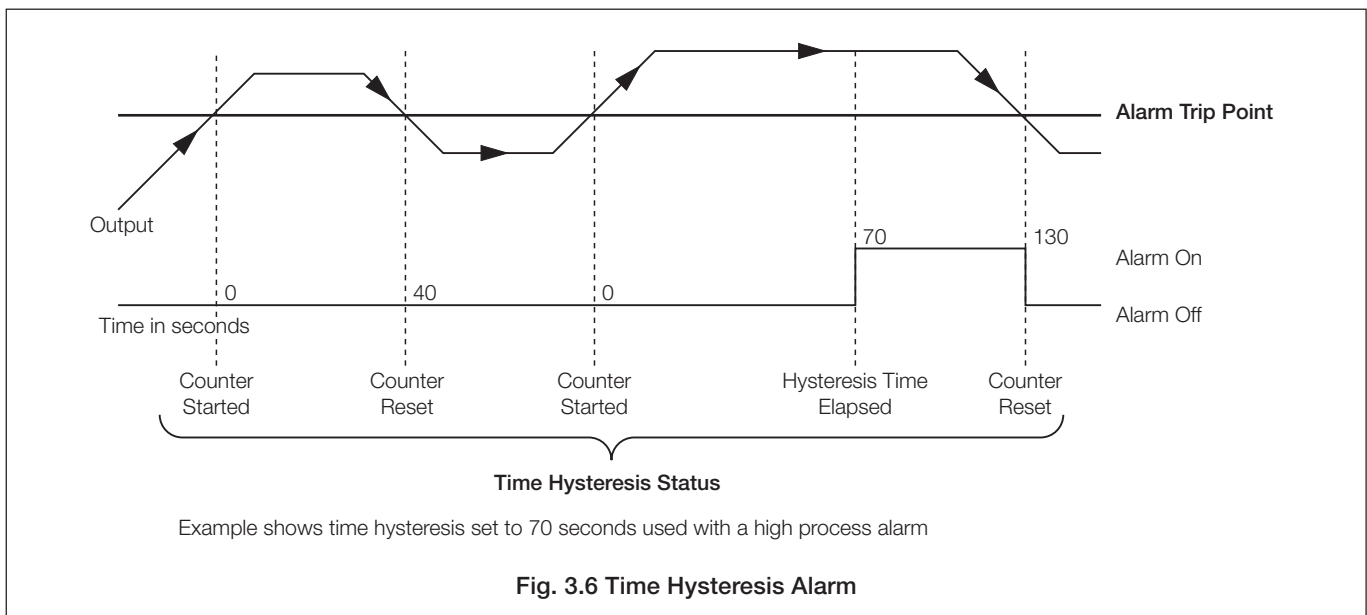
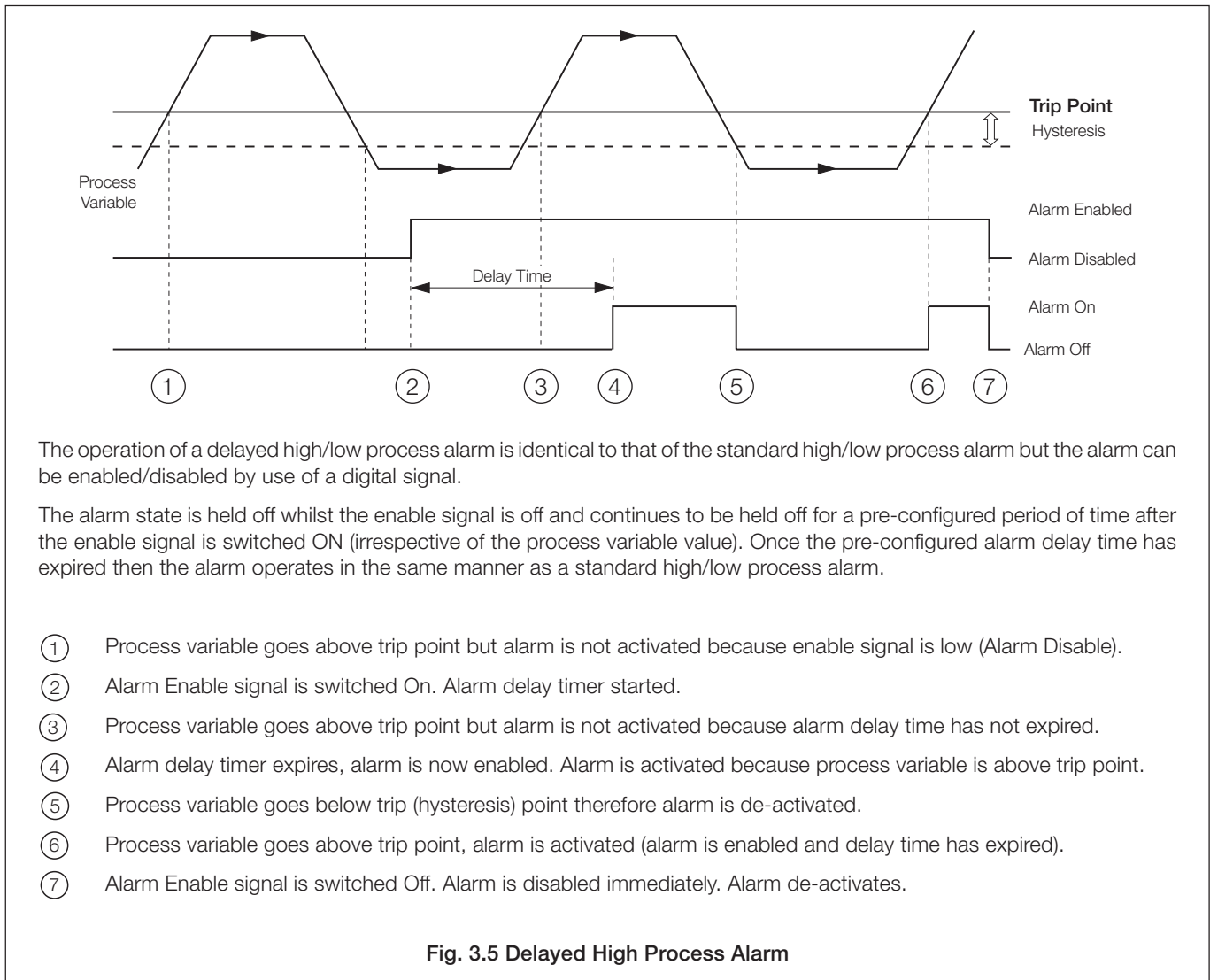

Fig. 3.4 High and Low Deviation with Hysteresis

...3.4 Set Up Alarms



...3.4 Set Up Alarms

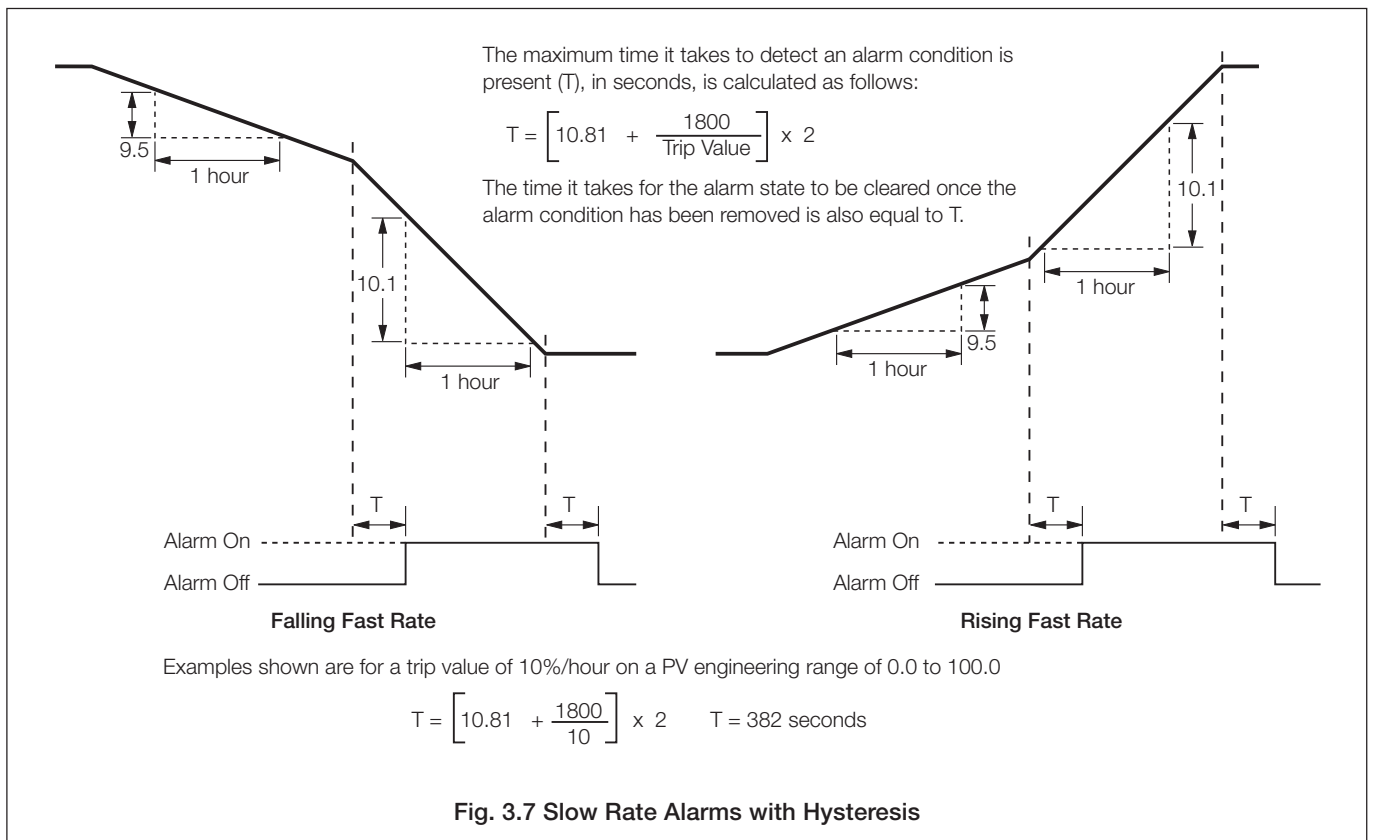

Fig. 3.7 Slow Rate Alarms with Hysteresis

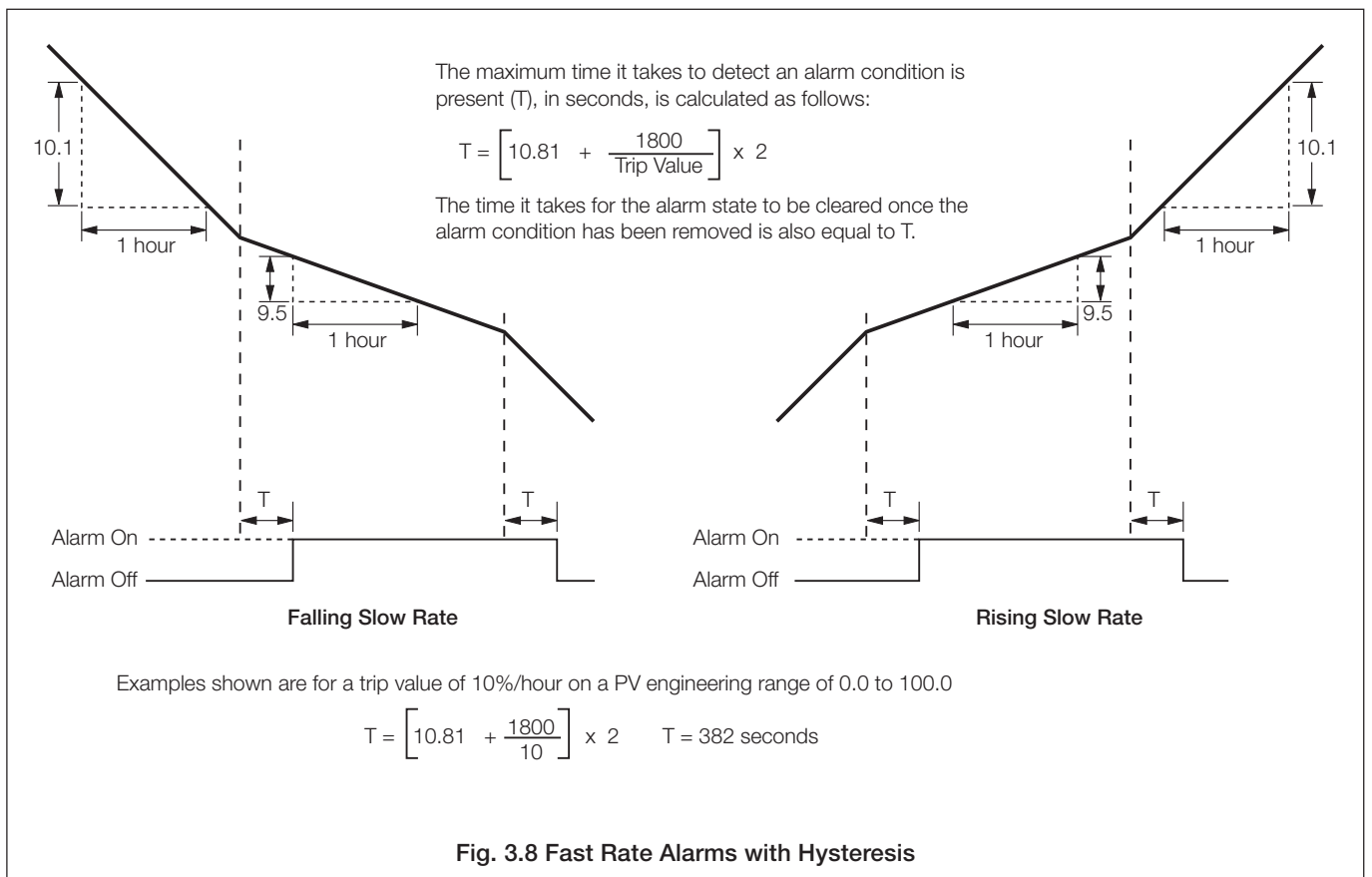
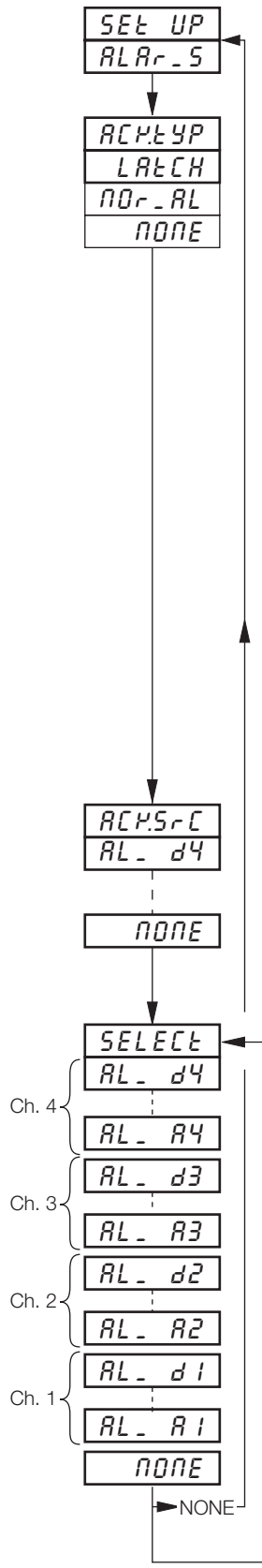

Fig. 3.8 Fast Rate Alarms with Hysteresis

...3.4 Set Up Alarms



Page Header – Set Up Alarms

To advance to **Set Up Relay Output Page** press the key.

Alarm Acknowledge Type

Alarms may be acknowledged while they are displayed.

Select the alarm acknowledge type:

none – no acknowledge facility. If the cause of the alarm no longer exists, the alarm state and display are cleared automatically.

Alarm cause	LED	Alarm State
Present	Flashing	Active
Not Present	Off	Inactive

NOR_AL and *LATCH* – if the cause of the alarm no longer exists, the alarm display remains until it has been acknowledged.

Alarm cause	Acknowledge	LED	Alarm State
Present	No	Flashing	Active
Present	Yes	Steady	Active
Not Present	Previously acknowledged	Off	Inactive
Present	No	Flashing	Active
Not Present	No	Flashing	Active/Inactive*
Not Present	Yes	Off	Inactive

*Alarm state is active if *LATCH* is selected or inactive if *NOR_AL* is selected.

Global Alarm Acknowledge Source

Select the alarm acknowledgment source required.

For a description of sources – see **Table 3.1** on page 18.

Select Alarm

Select the alarm to be programmed.

Note. In the remaining frames press the key to view the alarm selected.

Continued on next page.

...3.4 Set Up Alarms

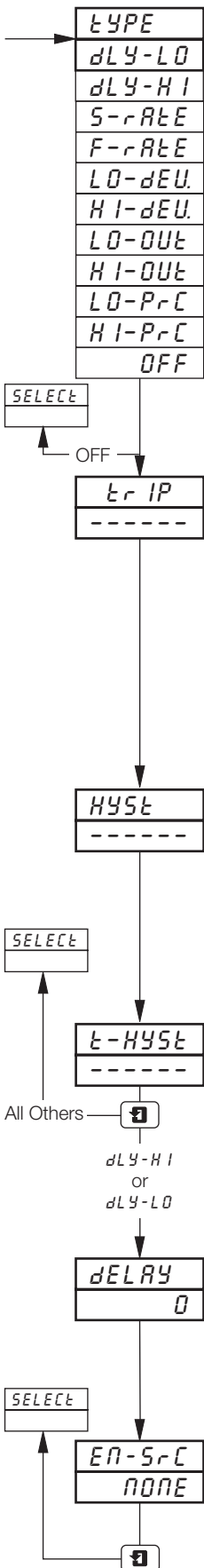

Alarm Type

Select the alarm type required for the alarm selected.

- dLY-LO* – delayed low process
 - dLY-HI* – delayed high process
 - S-rtE* – slow rate (rate of change of process variable)
 - F-rtE* – fast rate (rate of change of process variable)
 - LO-dEU* – low deviation
 - HI-dEU* – high deviation
 - LO-OUt* – low output
 - HI-OUt* – high output
 - LO-PrC* – low process
 - HI-PrC* – high process
 - OFF* – alarm off
- } Displayed only on Controller faceplate

Trip Level

Set the trip value required for the alarm selected.

The following are displayed in engineering units:

HP-rC, *LP-rC*, *HI-dEU* and *LO-dEU*.

The following are displayed as percentage (0.0 to 100.0%):

HI-OUt and *LO-OUt*.

The following are displayed as a percentage of the engineering span (engineering range high – engineering range low) per hour between ±0.5 and ±500%:

FrtE and *SrtE*.

Hysteresis

Hysteresis is operational when the alarm is active.

Set the hysteresis value required for high/low process or high/low deviation in engineering units (within the engineering range) or in 0.1% increments for fast/slow rate and high/low output alarms. The alarm is activated at the trip level but is only turned off after the alarm variable has moved into the safe region by an amount equal to the hysteresis value. For rate alarms this setting is a percentage of the trip rate – see *FrtE* and *SrtE* in previous frame.

Time Hysteresis

Set the time hysteresis value required between 0 and 9999 seconds.

Note. The alarm condition must be present continually for the time set, before the alarm becomes active. If a hysteresis level is also set, the alarm condition remains active until the process variable moves outside the hysteresis band. When the alarm condition no longer exists the alarm becomes inactive, i.e. time hysteresis does not affect turning off of alarm states.

Alarm Delay

After a transition of the enable signal from disabled to enabled, the alarm remains disabled for this period of time.

Set 0 to 250 minutes.

Enable Source

Any digital signal can be assigned as the signal to enable/disable the alarm.

Return to **Select Alarm** frame.

3.5 Set Up Relay Output

Information.

- **Relays** – can be energized by alarms, logic equation results, digital inputs, control and set point modes, real time events, (timer option), totalizer wrap signal (totaliser option) and ramp/soak programs/segments (profile option).
- **External Totalizer count function** – external counter can only be driven by relays fitted on module type 3 (4 relay module) in module positions 3, 4 and 5.
- **Polarity** – to allow failsafe settings.
- **Control outputs** – time proportioning (on type 1 and 2 modules or the first 2 relays only on type 3 module), valve open/close or on/off control.

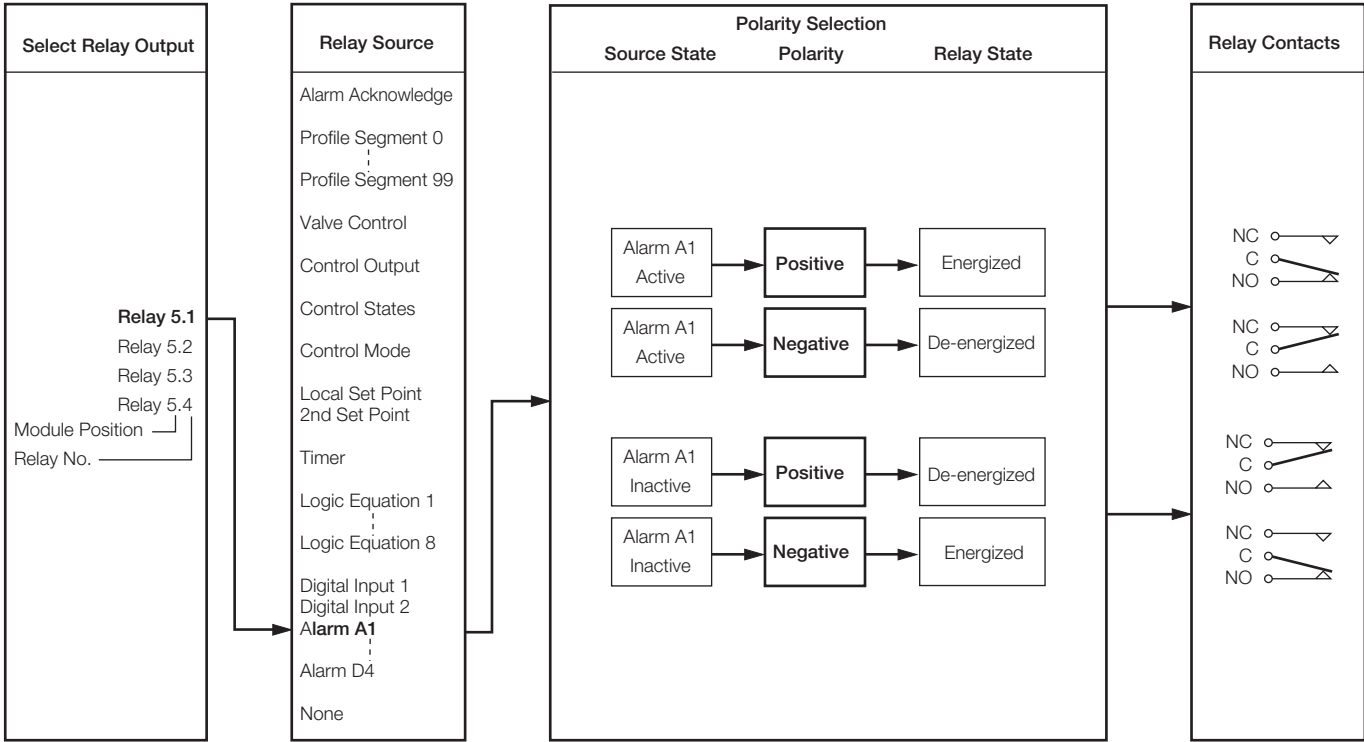

...3.5 Set Up Relay Output

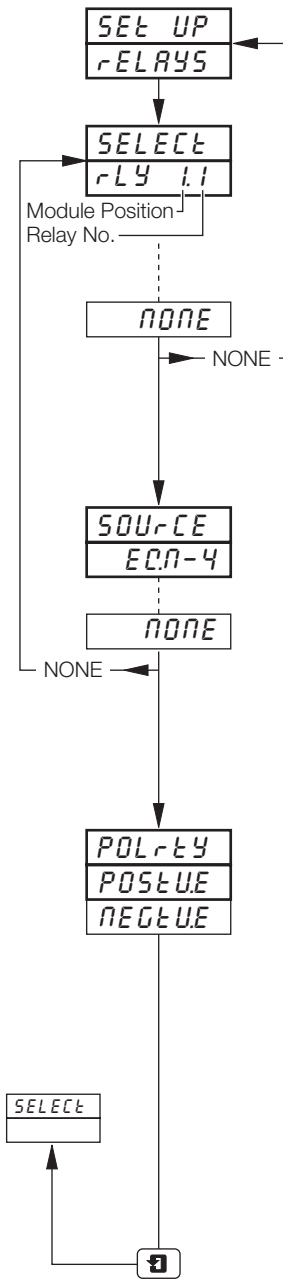

Page Header – Set Up Relays

To advance to **Set Up Digital Output Page** press the key.

Select Relay Output

Select the output to be programmed. The selections in this frame relate to the number of fitted modules with relays and their relative module positions.

Example – for a type 3 (four relays) module fitted in position five the following selections are also programmable:

- RELAY 5.1 (position 5, relay 1)
- RELAY 5.2 (position 5, relay 2)
- RELAY 5.3 (position 5, relay 3)
- RELAY 5.4 (position 5, relay 4)

Note. In the remaining frames press the key to view the relay selected.

Relay Source

Select the source required to activate the selected relay.

For description of sources, refer to **Table 3.1** on page 18.

Notes.

- Time proportioning control can be allocated only to the first two relays on a type 3 (4 relay) module or the relay on types 1 and 2 modules (standard I/O and analog + relay).
- To drive an external counter *COUNTx* must be selected.

Polarity

The polarity selection is used to invert the effect of the digital source state on the relay state as shown in the following table:

Source State	Polarity	Relay State
Active	Positive	Energized
	Negative	De-energized
Non-active	Positive	De-energized
	Negative	Energized

Select the polarity required.

Caution. Check connections before operating – see Section 6, **CONNECTIONS & LINKS**.

Return to **Select Relay Output** frame.

...3 BASIC CONFIGURATION LEVEL

Source	Description
<i>AL_ACP</i>	Alarm Acknowledge – Unacknowledged process alarm anywhere in the unit
<i>SEG-99</i> ⋮ <i>SEG-0</i> <i>PG-2.10</i> ⋮ <i>PG-1.01</i> <i>run-x</i> <i>HOLD-x</i> **PFAIL	Profile segment 99 ⋮ Profile segment 0 Profile program 10, Controller 2 ⋮ Profile program 1, Controller 1 Profile 1 or 2 running Profile 1 or 2 in Hold mode Power failure
*OPEN-x <i>CLSE-x</i>	Motorized valve 1 or 2 open Motorized valve 1 or 2 closed
*ONOFFx <i>OP-x</i> <i>OP-xc</i> <i>OP-xh</i>	Control output 1 or 2 on/off Control output 1 or 2 (time proportioning) Control output cool 1 or 2 (time proportioning) Control output heat 1 or 2 (time proportioning)
<i>2nd-x</i> <i>LOC-x</i>	Second set point Local set point
<i>_MAN-x</i> <i>AUTO-x</i>	Manual control Automatic control
<i>t1.Er.2</i> <i>t1.Er.1</i>	Real time event 2 Real time event 1
<i>EQN-8</i> <i>EQN-1</i>	Programmable logic equation 8 Programmable logic equation 1
<i>rAP-4</i> <i>COUNT.4</i> <i>rAP-1</i> <i>COUNT.1</i>	Wrap around on total 4 Total 4 external counter drive Wrap around on total 1 Total 1 external counter drive
<i>dIG-6.8</i> <i>dIG-1.1</i>	Digital Input 6.8 Digital input 1.1
	┌ Digital Input number └ Module number
<i>AL-d4</i> <i>AL-C4</i> <i>AL-b4</i> <i>AL-A4</i>	Alarm D Alarm C Alarm B Alarm A
<i>AL-d3</i> <i>AL-C3</i> <i>AL-b3</i> <i>AL-A3</i>	Alarm D Alarm C Alarm B Alarm A
<i>AL-d2</i> <i>AL-C2</i> <i>AL-b2</i> <i>AL-A2</i>	Alarm D Alarm C Alarm B Alarm A
<i>AL-d1</i> <i>AL-C1</i> <i>AL-b1</i> <i>AL-A1</i>	Alarm D Alarm C Alarm B Alarm A
<i>NONE</i>	No source required

* Available only on 4-relay and 8-digital output modules (types 3 and 5), fitted in module positions 4,5 and 6.

** Available only for relay assignment.

Table 3.1 Description of Sources

3.6 Set Up Digital Output

Information.

- **This page is not displayed if there are no digital outputs fitted.**
- **Up to 24 digital outputs are available** – depending on the module types fitted.
- **Digital outputs** – can be energized by alarms, logic equations results, digital inputs, real time events (if timer option is fitted), control modes, set points, ramp/soak profile segments or programs (if fitted) and totalizer wrap signal (if fitted).
- **Control outputs** – time proportioning (on first two digital outputs of any module), valve open/close and on/off control.
- **External Totalizer count function** – external counter can only be driven by a type 5 module (8 digital outputs) fitted in module positions 4, 5 or 6.
- **Polarity** – inverts the effect of the selected source on the output state.

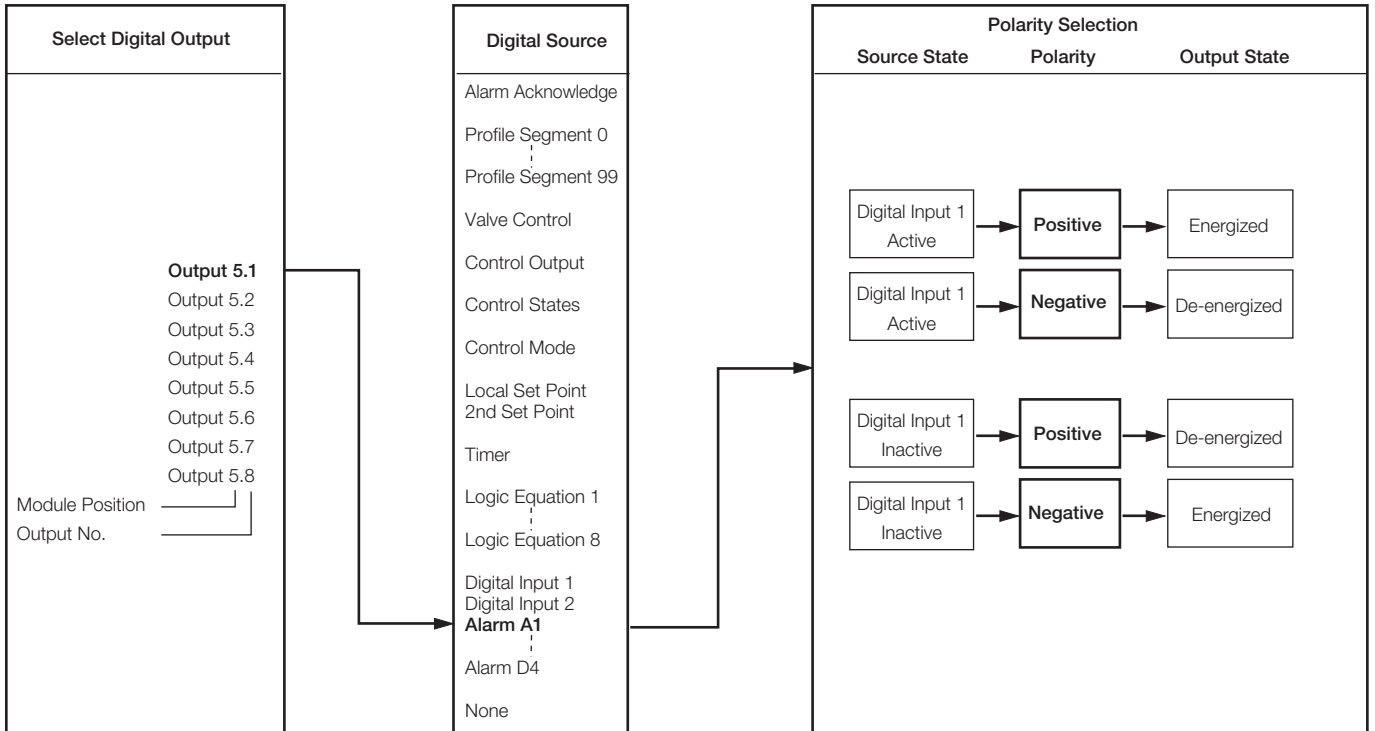

...3.6 Set Up Digital Output

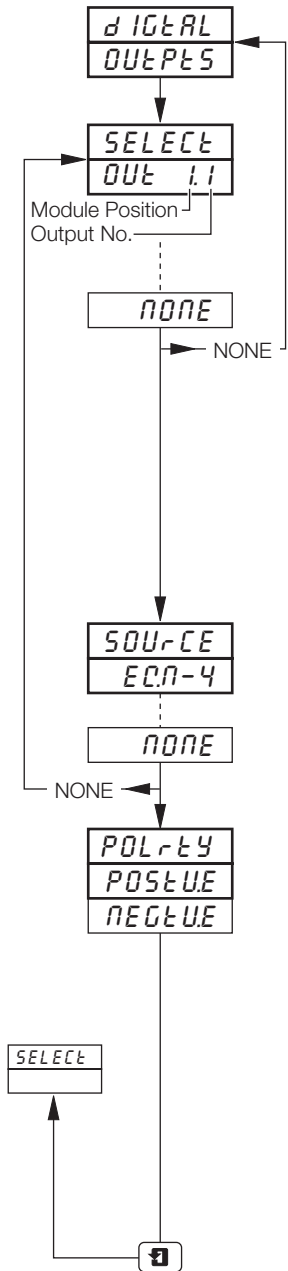

Page Header – Set Up Digital Outputs

To advance to **Set Up Analog Output Page** press the key.

Select Digital Output

Select the output to be programmed – the selections in this frame relate to the number of fitted digital output modules and their relative module positions.

Example – for a type 5 (eight digital outputs) module fitted in position five the following selections are also programmable:

- OUT 5.1 (position 5, output 1)
- OUT 5.2 (position 5, output 2)
- OUT 5.3 (position 5, output 3)
- OUT 5.4 (position 5, output 4)
- OUT 5.5 (position 5, output 5)
- OUT 5.6 (position 5, output 6)
- OUT 5.7 (position 5, output 7)
- OUT 5.8 (position 5, output 8)

Note. In the remaining frames press the key to view the output selected.

Output Source

Select the source required to activate the selected digital output.

For description of sources, refer to **Table 3.1** on page 18.

Note. To drive an external counter *COUNT.x* must be selected.

Polarity

The polarity selection is used to invert the effect of the source state on the output as shown in the following table:

Source State	Polarity	Output State
Active	Positive	Energized
	Negative	De-energized
Non-active	Positive	De-energized
	Negative	Energized

Select the polarity required.

Caution. Check connections before operating – see Section 6, **CONNECTIONS & LINKS**.

Return to **Select Digital Output** frame.

3.7 Set Up Analog Output

Information.

- **Fitted analog outputs** – assignable to retransmit any input (process variable, remote set point or position feedback) or provide the control output.
- **Selectable retransmission range** – allows maximum resolution on range of interest.
- **Adjustable output range** – for non-standard and reversed outputs.

Note. The example below shows analog output 1 set to retransmit part of process variable 1's engineering range (250 to 750°C) as a 4.0 to 20.0mA current output.

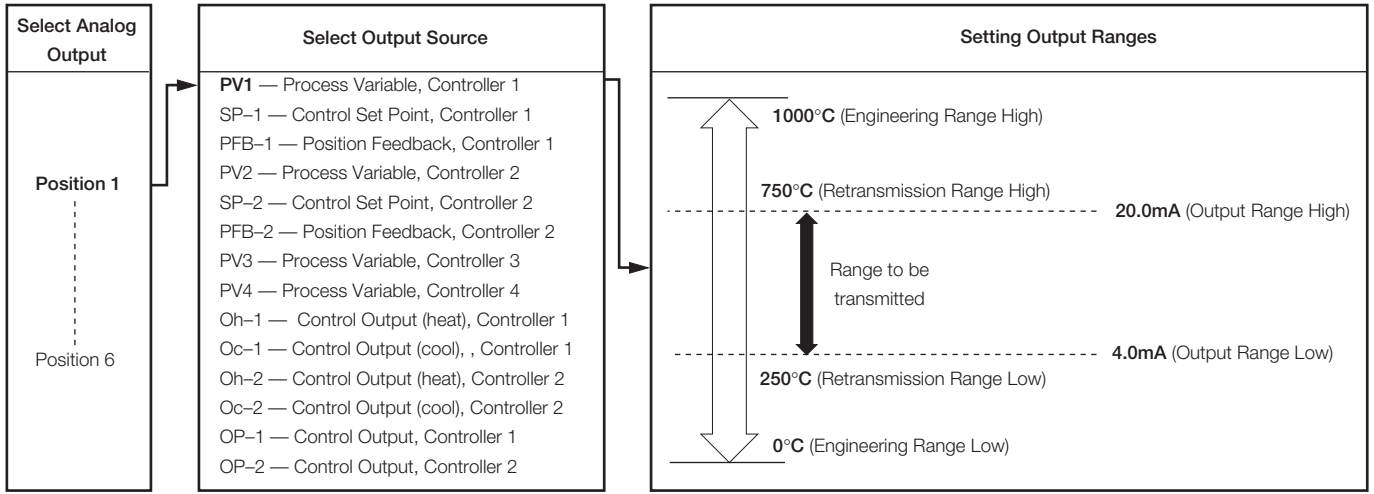

...3.7 Set Up Analog Output

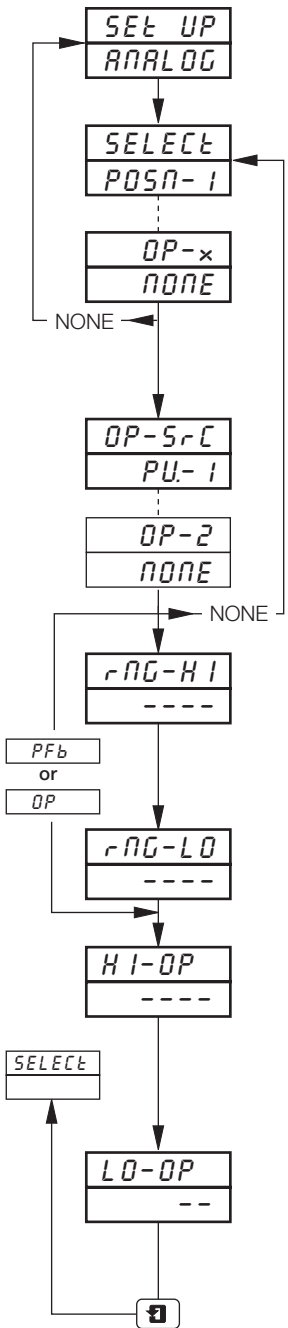

Page Header – Set Up Analog Output

To advance to **Digital Inputs Page** press the key.

Select Analog Output

Select the analog output position to be programmed. The selections in this frame relate to the number of fitted modules with analog output.

Example – Output 1 is the analog output in position 1 (fitted on the main board), output 3 is the analog output fitted in module position 3.

Note. In the remaining frames press the key to view the analog output selected.

Output Source

Select output source required. The selections in this frame correspond to the inputs (Process Variable, Set Point and Position Feedback) and controller outputs available.

Retransmission Range High

Set the engineering range value (in engineering units) at which maximum output is required.

Retransmission Range Low

Set the engineering range value (in engineering units) at which minimum output is required.

Output Range High

Set the maximum current output required for the **Retransmission Range** programmed between 2.0 and 20.0mA.

Output Range Low

Set the minimum current output required for the **Retransmission Range** programmed between 2.0 and 20.0mA.

Return to **Select Analog Output** frame.

3.8 Digital Inputs

Information.

- Up to 30 digital inputs are available – depending on the module types fitted.
- Volt-free contacts or TTL levels.
- Polarity – sets the logic state (unchanged or inverted) for the module position(s).

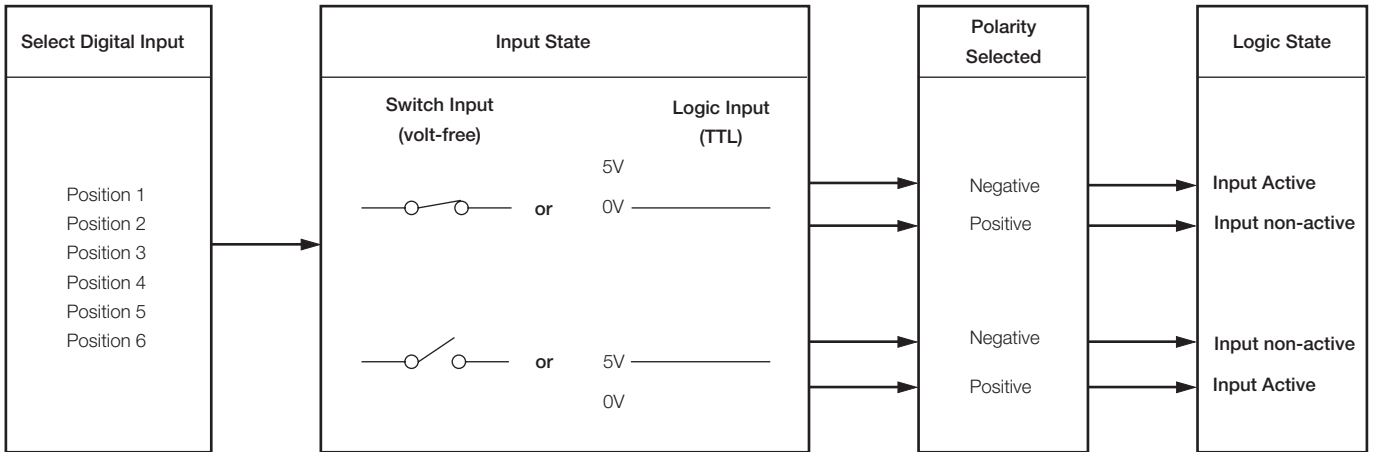

Page Header – Digital Inputs

To advance to **Access Page** press the key.

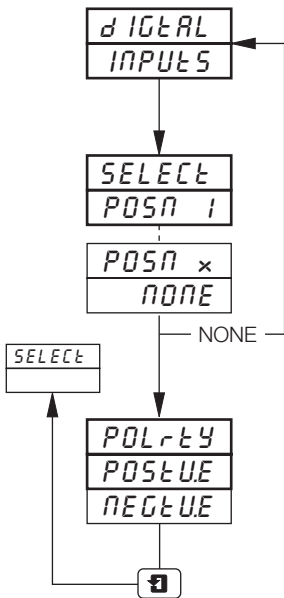

Select Digital Input

Select digital module position to be programmed.

Note. In the remaining frames press the key to view the module position selected.

Polarity

Select the polarity required for the module position selected above:

- POStUE* – logic input state unchanged
- NEGtUE* – logic input state inverted

Return to **Select Digital Input** frame.

3.9 Access Page

Information.

- Configurable password protection – of programming levels.
- Internal security link – enable/disable password protection.

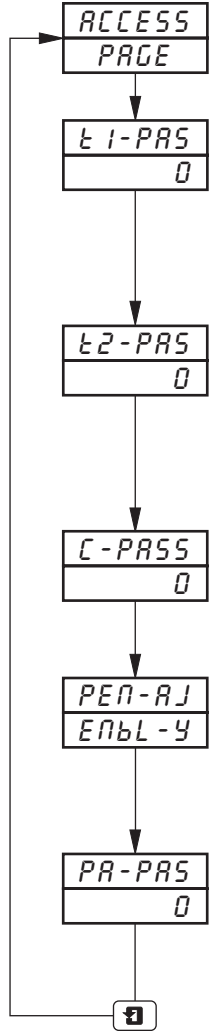

Page Header – Access Page.

To advance to **Scale Adjust Page** press the key.

Tune Password 1 (Controller 1)

A tune password can be assigned to controller 1 to prevent access to its control settings.

Set the required password, between 0 and 9999.

Not available if channel 1 is not a controller.

Tune Password 2 (Controller 2)

A tune password can be assigned to controller 2 to prevent access to its control settings.

Set the required password, between 0 and 9999.

Not available if channel 2 is not a controller.

Configuration Password

Prevents access to the programming pages.

Set the required password, between 0 and 9999.

Pen Adjust Enable

Enables / Disables the pen adjustment feature.

This allows the position of any trend to be adjusted for checking against a reference standard. The displayed value is not changed.

Pen Adjust Password

Prevents access to the pen adjustment.

Set the required password, between 0 and 9999.

Return to top of **Access Page**.

...3.9 Access Page

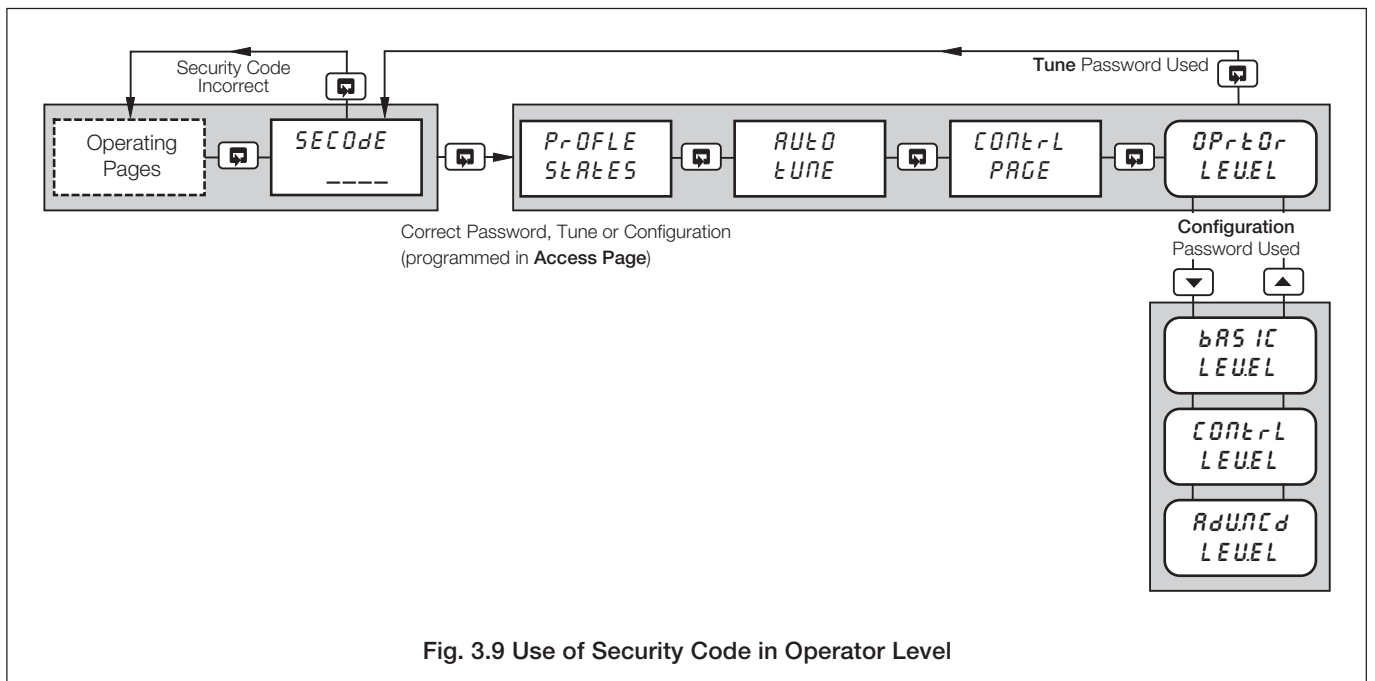

Fig. 3.9 Use of Security Code in Operator Level

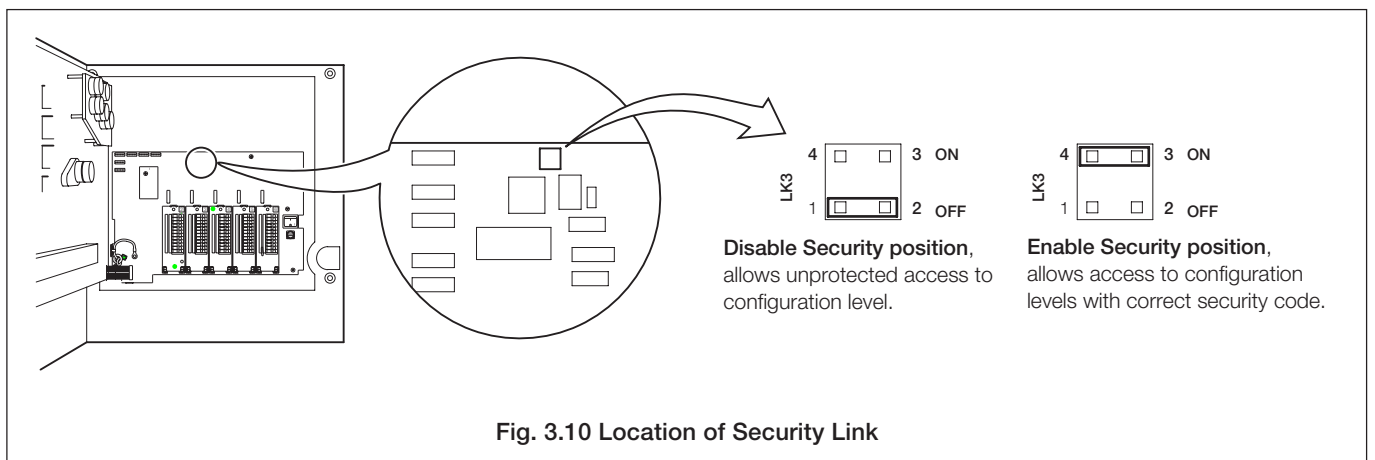

Fig. 3.10 Location of Security Link

3.10 Scale Adjust

Information.

- **Analog Inputs** – do not require re-calibrating when the input type or range is changed.
- **Span and offset adjust reset** – removes any previously programmed Offset or Scale Adjustment settings.
- **System offsets errors** – can be removed from Process Variables, Remote Set Points and Position Feedback inputs using Scale Offset Adjustment.
- **System scale errors** – can be removed from Process Variables, Remote Set Points and Position Feedback inputs using span adjustment.
- **Offset/span adjustment** – can be used to perform spot calibration.
- **Pen(s)** – can be independently calibrated and checked across the full range of the chart.
- **Mains filter** – selectable for maximum noise rejection.
- **Pen Linearity Check** – automatically draws a pen linearity test pattern.

Scale Adjustment

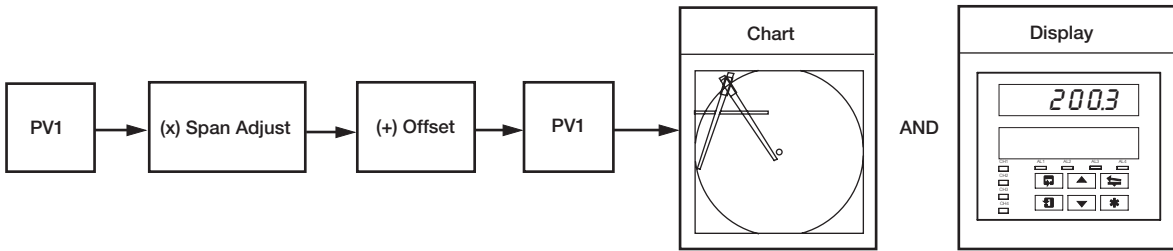

Offset Adjustment

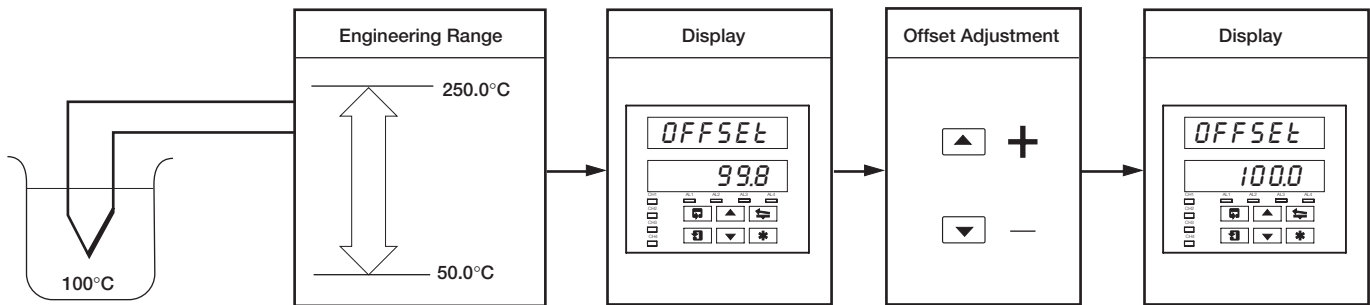

Span Adjustment

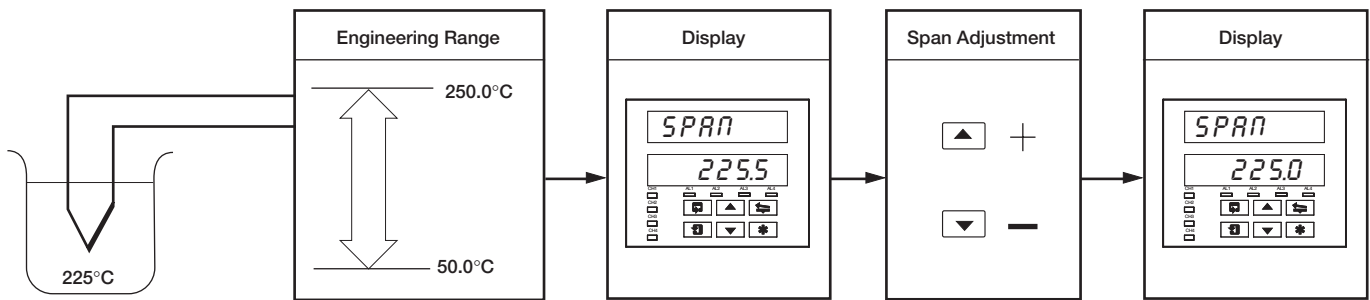

Note. As a general rule:

- use **Offset** adjustment for spot calibration at <50% of engineering range span.
- use **Span** adjustment for spot calibration at >50% of engineering range span.

...3.10 Scale Adjust

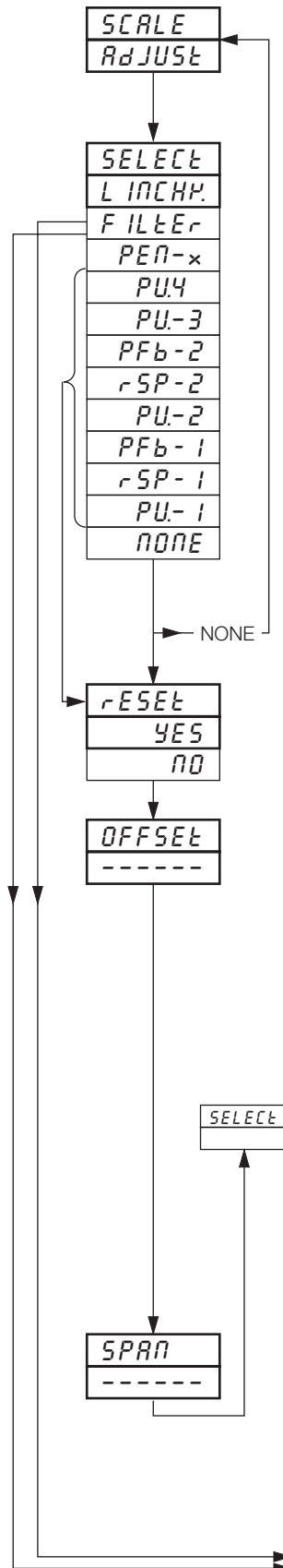

Page Header – Scale Adjust

To advance to **BASIC CONFIGURATION LEVEL** frame use the key.

Select Process Variable/Pen

Select process variable or pen required:

- L INCHY.* – the pens automatically draw a test pattern to check pen linearity. *DONE* is displayed on completion
 - F ILtEr* – mains frequency filter
 - PEN x* – pens 1 to 4
 - PU-4* – process variable on channel 4
 - PU-3* – process variable on channel 3
 - PFB-2* – valve position feedback on controller 2
 - rSP-2* – remote set point on controller 2
 - PU-2* – process variable on channel 2
 - PFB-1* – valve position feedback on controller 1
 - rSP-1* – remote set point on controller 1
 - PU-1* – process variable on channel 1
 - NONE* – None
- } displayed only if selected in the **Input Assignment Page**
- } displayed only if selected in the **Input Assignment Page**

Note. In the remaining frames press the key to view the input or pen selected. Only pens assigned to trend functions are displayed in this frame.

Scale Adjustment Reset

Set *YES* to reset the offset and span values to their nominal values (values are reset on advancing to the next frame).

Offset Adjustment

Electrical and resistance inputs: apply the correct input for the spot calibration required.

RTD inputs: use resistance values obtained from standard tables.

Thermocouple Inputs: measure the ambient temperature at the output terminals of the signal source (calibrator). From thermocouple tables obtain the millivolt equivalent of this temperature (a) and that for the spot calibration temperature (b). Subtract (a) from (b) and set the signal source to the resultant value. (The voltage is negative if the spot calibration temperature is below the measured ambient temperature).

Note. The displayed units are engineering units.

Set the value required. The decimal point position is set automatically.

Example – If the display range is 50.0 to 250.0 and a spot calibration is required at 100 and 225, inject a signal equivalent to 100 and set the display to 100.0 using the and keys.

Span Adjust

Proceed as for **Offset Adjustment** above and apply the correct input for the spot calibration required. The displayed units are engineering units. Set the value required. The decimal point is set automatically.

For the example above, inject a signal equivalent to 225 and then set the display to 225.0.

Continued on next page.

...3 BASIC CONFIGURATION LEVEL

...3.10 Scale Adjust

SELECT
PEN-x

SELPEN
Rt 100

SELPEN
Rt 0

SELECT
PEN

CHECK
--.-



SELECT
FILTER

FILTER
50 Hrt
50 Hrt

SELECT
FILTER



Calibrate Pen At 100%

Drives the pen automatically to the full scale position on the chart.

Use the ▲ and ▼ keys to set pen to 100% on the chart.

Calibrate Pen At 0%

Drives the pen automatically to the zero position on the chart.

Use the ▲ and ▼ keys to set pen to 0% on the chart.

Check Pen Calibration

The pen calibration can be checked at any point on the chart.

Use the ▲ and ▼ keys to move the selected pen from the zero point up to the 100% position on the chart.

Note. If the true time event option is fitted the red pen does not move beyond the 94% position on the chart.

Select Filter

Select the mains frequency of the supply used to ensure maximum noise rejection on analog inputs.

Return to **Select Process Variable/Pen** frame.

4 CONTROL CONFIGURATION LEVEL

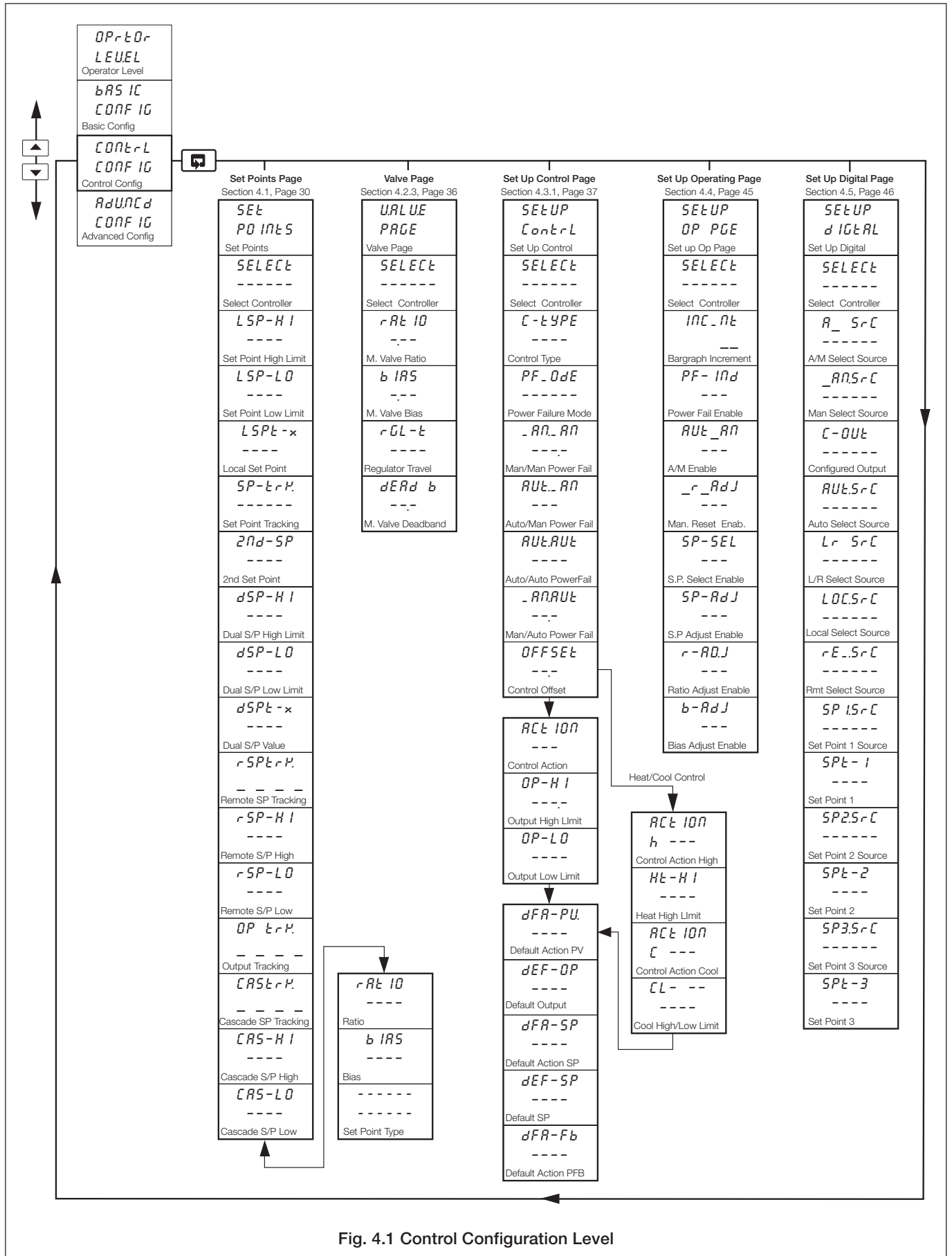

Fig. 4.1 Control Configuration Level

4.1 Set Points

Information.

- Two local set points – Local and Dual.
- Remote set point facility – with Ratio and Bias.
- Remote set point tracking options – for bumpless Remote-to-Local set point transfers.
- Cascade control on second controller with optional output tracking.
- Adjustable high and low limits for all set point types.
- Set point tracking for bumpless Manual-to-Auto transfers.

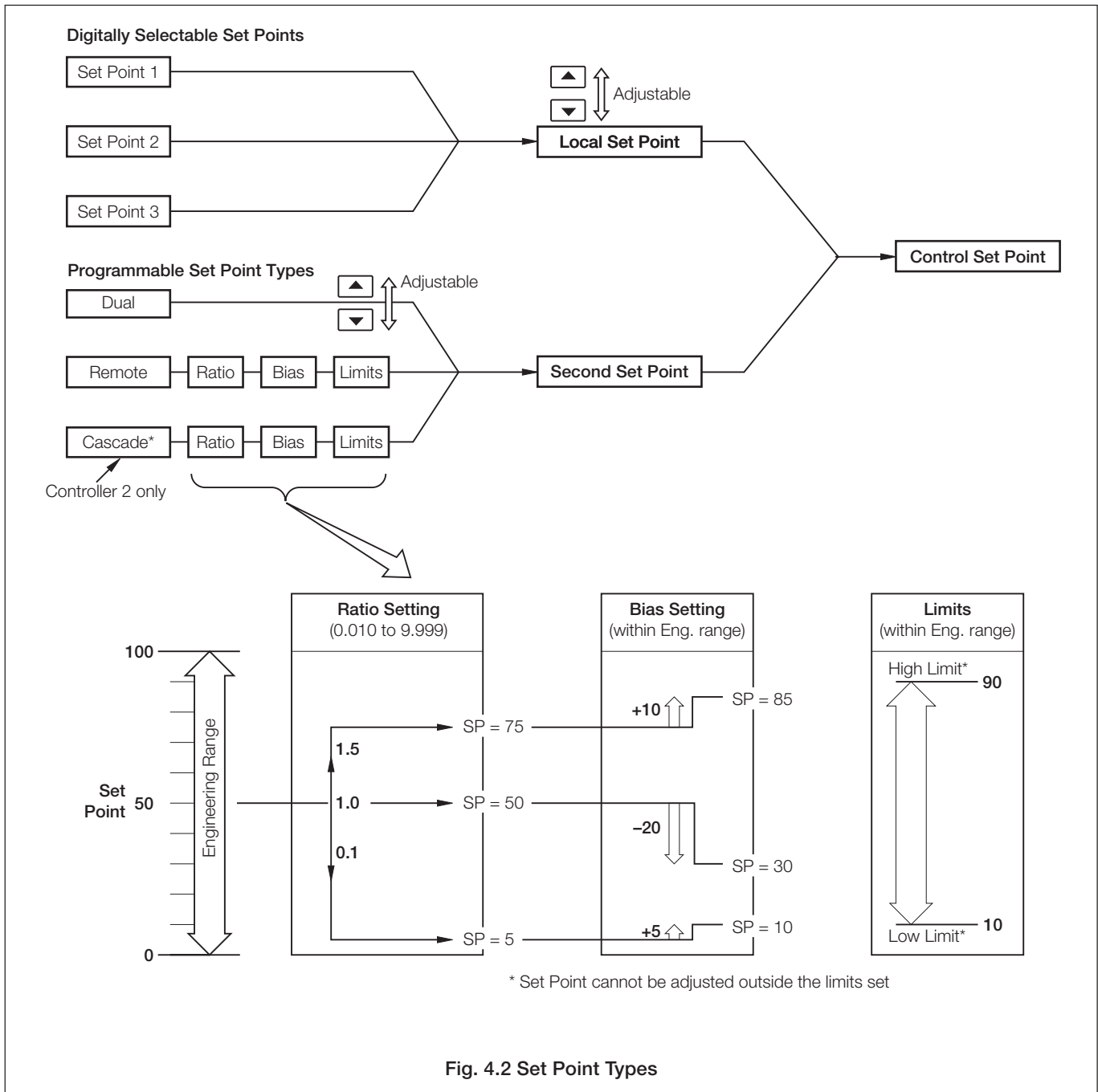

Fig. 4.2 Set Point Types

...4.1 Set Points

Information.

- **Cascade control** – comprises two series-connected controllers (master and slave), each containing a complete measuring and controlling system operating on a single regulating device. Cascade control is only available when two control front panels are fitted (channel 1 and channel 2) and channel 2 has no Remote set point facility. Channel 1 is the 'Master' controller and channel 2 is the 'Slave' controller.
- **Cascade control with output tracking** – ensures bumpless transfer when switching between auto/manual modes, i.e. when the slave is switched to Manual it switches the Master to Manual, automatically.
- **Cascade control with set point tracking** – ensures bumpless transfer when switching between local/cascade set points modes.

4.1.1 Cascade Control (without output tracking)

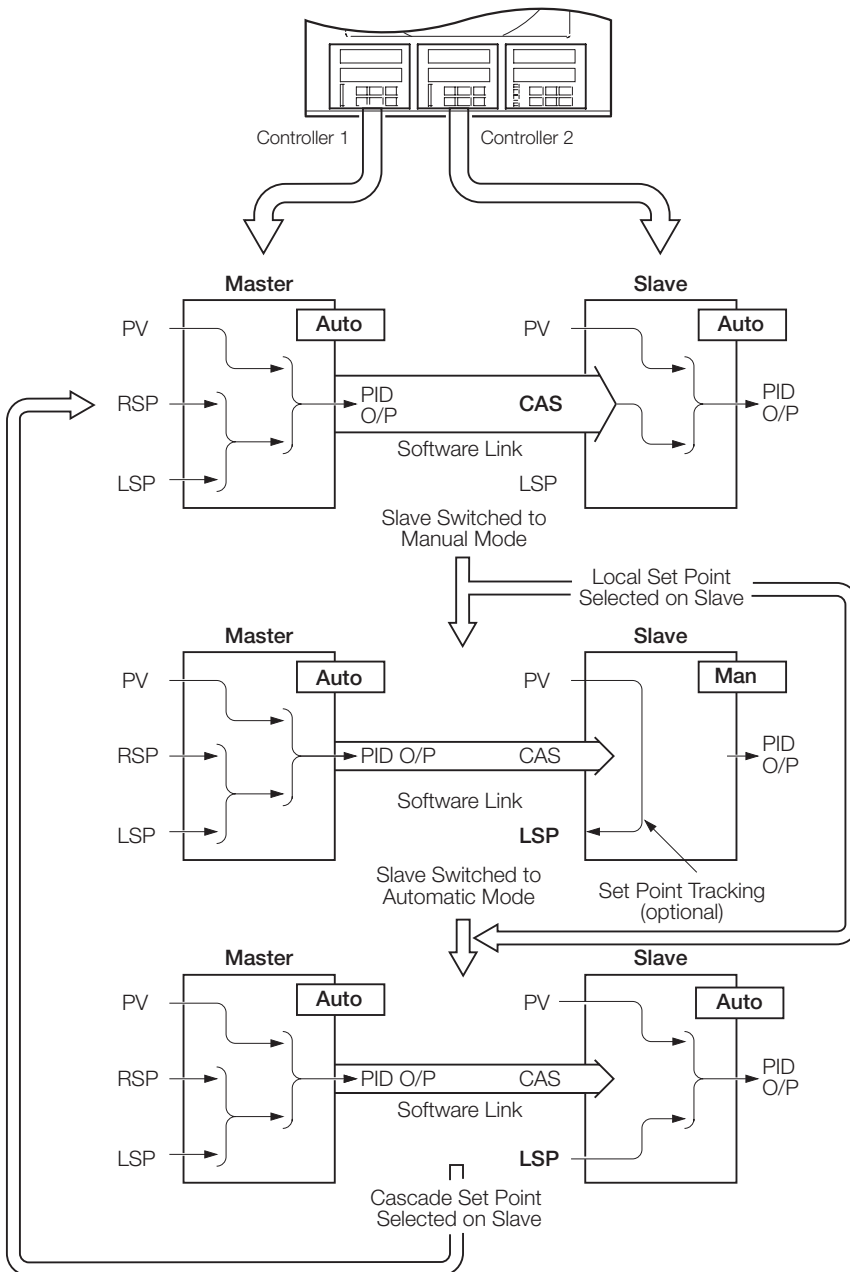

Full Automatic Cascade Control Mode

A ratio and bias can be applied to the cascade set point (derived from the master output) to give the required slave set point.

To switch to **Manual Mode**, press the key to select manual mode on the slave.
To switch to **Local Set Point Mode**, select local set point in **Operating Page** of the slave.

Manual Mode

If the slave is switched from automatic control to manual control, with cascade set point selected, the set point type automatically reverts to local, irrespective of the output tracking setting.

Local Set Point Mode

If local set point is selected on the slave when in **Full Automatic Cascade Mode**, operation of the master is not affected.

To return to **Full Automatic Cascade Mode**:

Press the key to select automatic mode on the slave and select cascade set point in **Operating Page** of the slave.

4.1.2 Cascade Control (with output tracking)

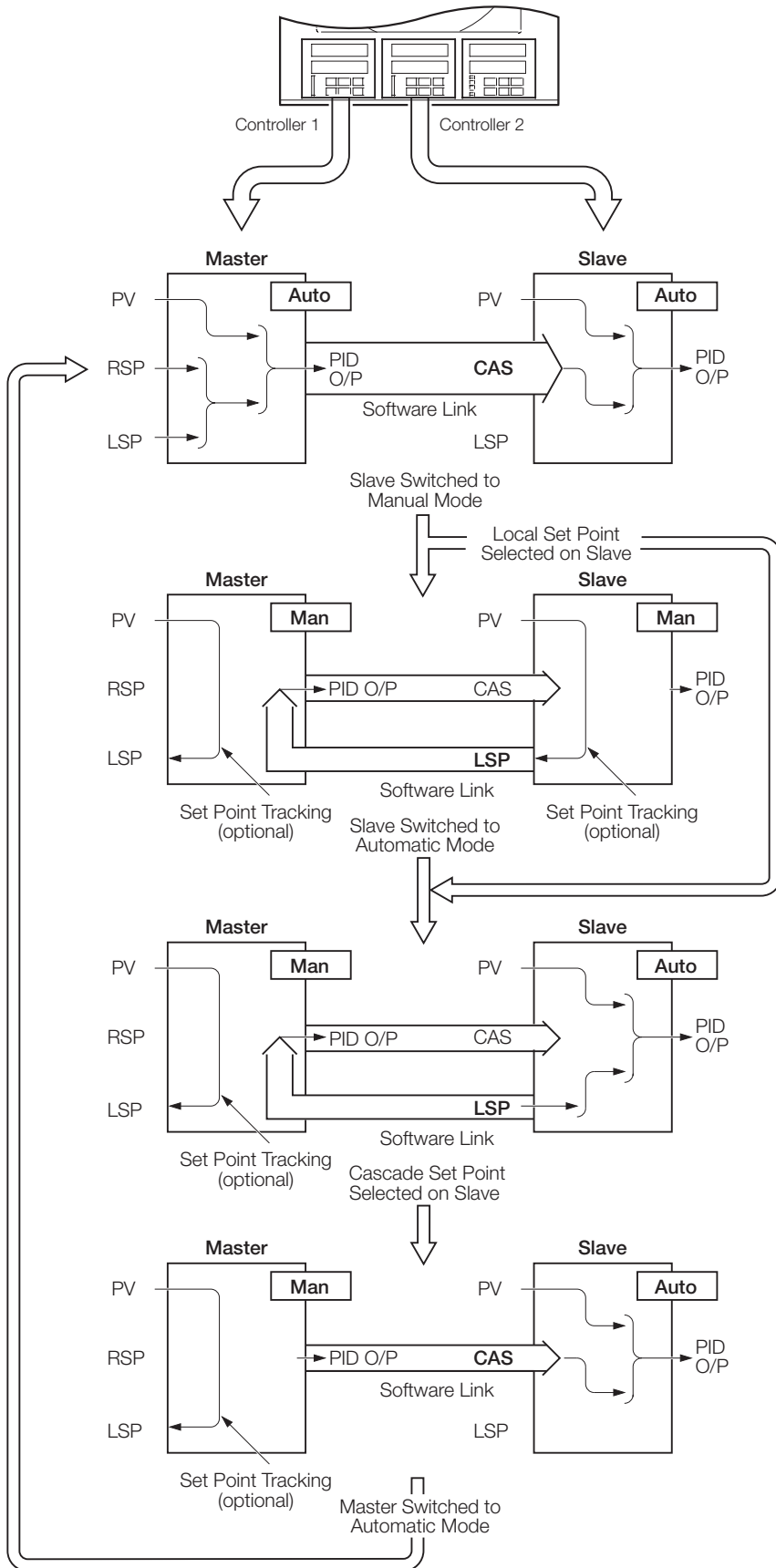

Full Automatic Cascade Control Mode

A ratio and bias can be applied to the cascade set point (derived from the master output) to give the required slave set point.

To switch to **Manual Mode**, press the key to select manual mode on the slave.

To switch to **Local Set Point Mode**, select local set point in **Operating Page** of the slave.

Manual Mode

If the slave is switched from automatic control to manual control, with cascade set point selected, the set point type automatically reverts to local, irrespective of the output tracking setting. The master is automatically switched to manual control.

Local Set Point Mode

If local set point is selected on the slave when in **Full Automatic Cascade Mode**, the master is automatically switched to manual mode.

To return to **Full Automatic Cascade Mode**: press the key to select automatic mode on the slave, select cascade set point in **Operating Page** of the slave and press the key to select automatic mode on the master.

4.1.3 Set Points Page

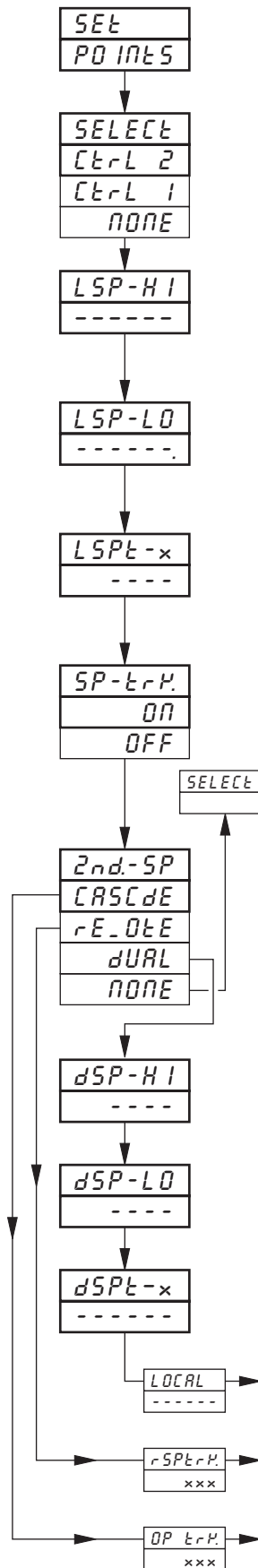

Page Header – Set Points.

To advance to **Valve Page** press the key.

Select Controller

Select the controller to be programmed (1 or 2).

Note. In the remaining frames press the key to view the controller selected.

Local Set Point High Limit

The high limit is the maximum value to which the local set point can be adjusted. Set the value required. The decimal point position is set automatically.

Set Point Low Limit

The low limit is the minimum value to which the local set point can be adjusted. Set the value required. The decimal point position is set automatically.

Local Set Point Value

Set the value required, within the limits set above. The decimal point position is set automatically to that of the engineering range (**Set Up Input Page, BASIC CONFIGURATION LEVEL**).

Set Point Tracking Enable

If Set Point Tracking is enabled and the controller is in Manual mode the local set point tracks the process variable. When the controller is in Set Point Tracking mode the local set point limits can be exceeded. If the local set point is outside of its limits when automatic control mode is selected, the local set point value can only be adjusted towards its limits. Once within the limits they apply as normal. Select *ON* to enable or *OFF* to disable.

Second Set Point Type:

enables the setting up of a second set point in addition to the local set point. Select the second set point type, *NONE* (no second set point), *dUAL* (a second local set point), *rE-DE* (remote set point), or *CASCdE* (only available on controller 2).

Note. The *rE-DE* selection is displayed only if enabled in the **Input Assignment Page, ADVANCED CONFIGURATION LEVEL**.

Dual Set Point High Limit

The high limit is the maximum value to which the dual set point can be adjusted. Select the value required. The decimal point position is set automatically.

Dual Set Point Low Limit

The low limit is the minimum value to which the dual set point can be adjusted. Select the value required. The decimal point position is set automatically.

Dual Set Point Value

Set the value required, within the limits set above. The decimal point position is set automatically to that of the engineering range (**Set Up Input Page, BASIC CONFIGURATION LEVEL**).

Continued on next page.

...4.1.3 Set Points Page

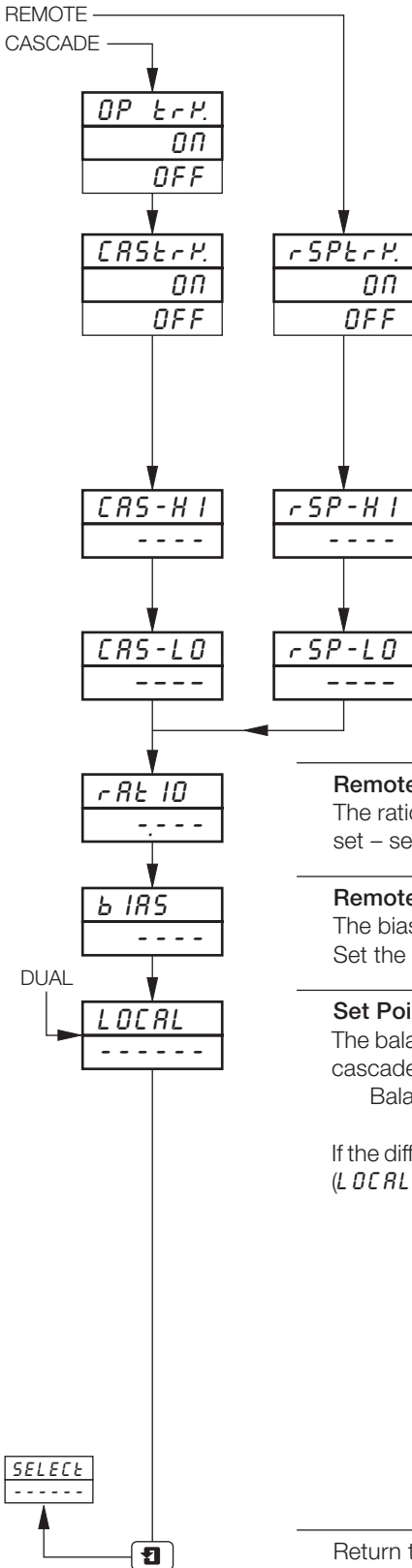

Output Tracking Enable

With Output Tracking enabled, if the slave controller is changed to local set point, the Master output tracks the local set point value of the slave.

Remote (Cascade) Set Point Tracking Enable

If Remote (Cascade) Set Point Tracking is enabled and the controller is in Remote (Cascade) mode the local set point tracks the remote set point. When the controller is in Remote (Cascade) Set Point Tracking mode the local set point limits can be exceeded. If the local set point is outside of its limits when selected, the set point can only be adjusted towards its limits. Once within the limits they apply as normal. With remote set point tracking enabled; if the controller is put into manual mode, the set point reverts from remote to local. Select *ON* to enable or *OFF* to disable.

Remote (Cascade) Set Point High Limit

The high limit is the maximum value to which the remote (cascade) set point can be adjusted. Select the value required. The decimal point position is set automatically.

Remote (Cascade) Set Point Low Limit

The low limit is the minimum value to which the remote (cascade) set point can be adjusted. Select the value required. The decimal point position is set automatically.

Remote (Cascade) Set Point Ratio

The ratio is a scaling factor, i.e. multiplies the remote (or cascade) set point input by the ratio value set – see Fig. 4.2. Set the required ratio, between 0.010 and 9.999 in 0.001 increments.

Remote (Cascade) Set Point Bias

The bias is an offset which is added to the remote (cascade) set point value – see Fig. 4.2. Set the required bias, in engineering units.

Set Point Type Selection

The balance (*bALANCE*) display shows the difference between the local and second (remote, dual or cascade) values, i.e.

$$\text{Balance} = \text{Second set point} - \text{Local set point}$$

If the difference is too great, press the **1** or **2** key to exit this frame, select the local set point frame (*LOCAL*) in this page or the **Operating Page** and adjust to an acceptable balance.

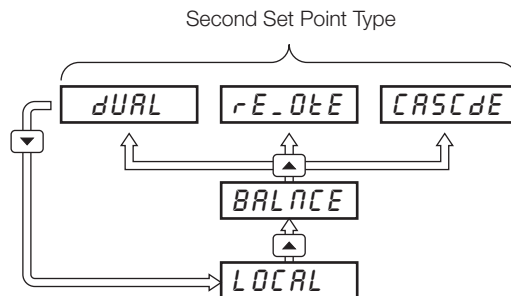

Return to **Select Controller** frame.

4.2 Motorized Valve Control

Information.

- This page is not displayed if position proportioning or boundless control is not enabled on either controller.
- Motorized valve control with or without feedback – position-proportioning (with feedback) or boundless (without feedback).
- Ratio and bias settings – can be applied to adjust the range of valve travel (position-proportioning only).
- Deadband setting – adjustable to minimize hunting of the motorized valve.

4.2.1 Motorized Valve with Feedback (Position-Proportioning) – Fig. 4.3

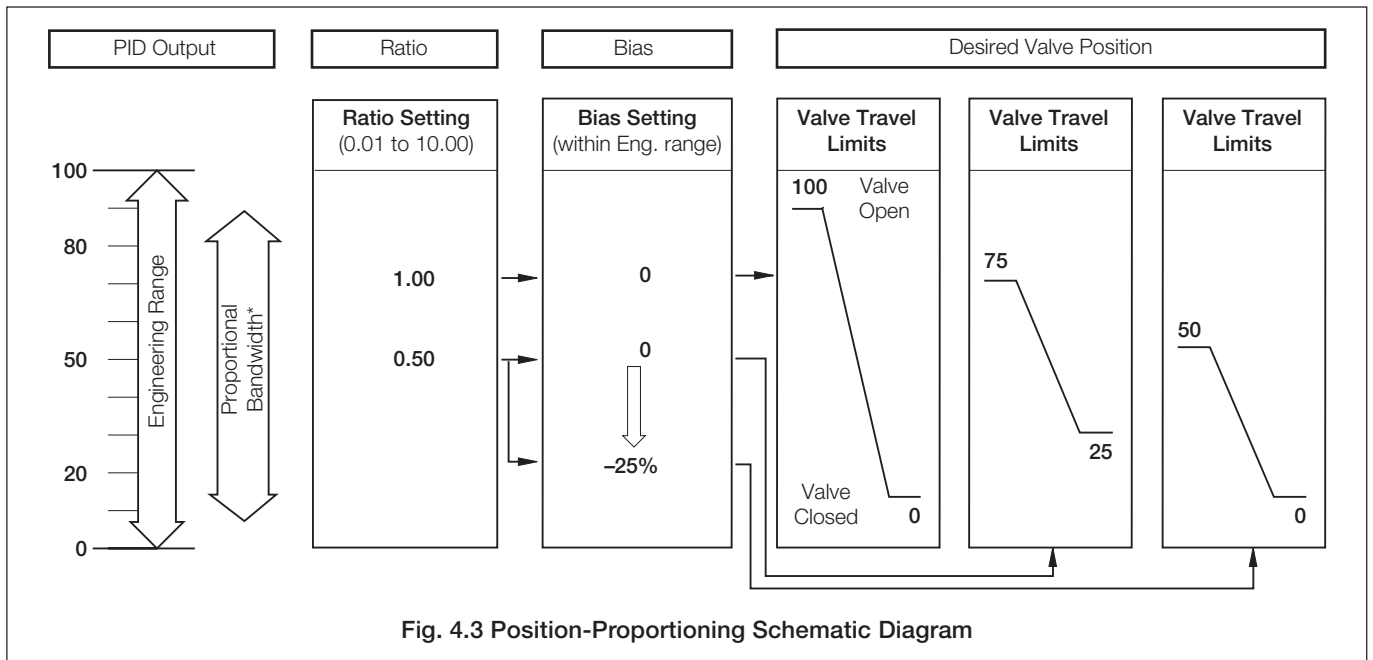

4.2.2 Motorized Valve Control without Feedback (Boundless) – Fig. 4.4

A 'boundless' process controller provides an output that is effectively the time derivative of the required regulator position, i.e. the controller signals the regulator, not where to go to (position derivative), but in which direction to travel and how far to move, by a series of integral action pulses. Thus, the controller does not need to know the absolute regulator position and is unaffected when the regulator reaches the upper or lower limit, as determined by the regulator's limit switches (giving rise to the term 'boundless').

In this system, the final regulator must act as an integrator, integrating both the raise and lower pulses in direction and duration so that the final position of the regulator reproduces the required 2 or 3 term control function, and must remain stationary indefinitely in the absence of raise or lower commands.

When a deviation from set point is introduced the regulator is driven, for a length of time equivalent to the proportional step. The regulator is then driven by integral action pulses until the deviation is within the deadband setting.

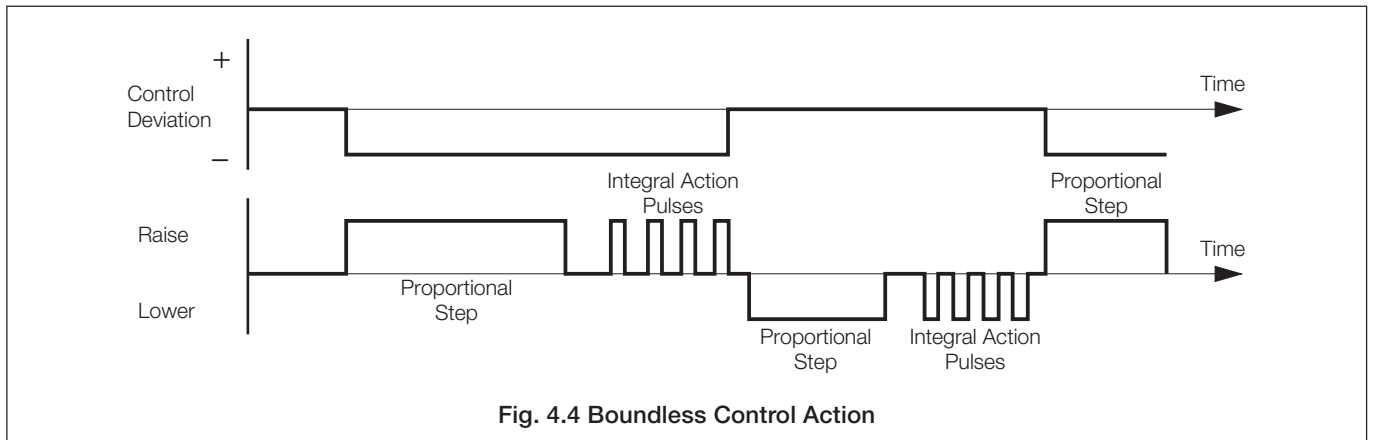

4.2.3 Valve Page

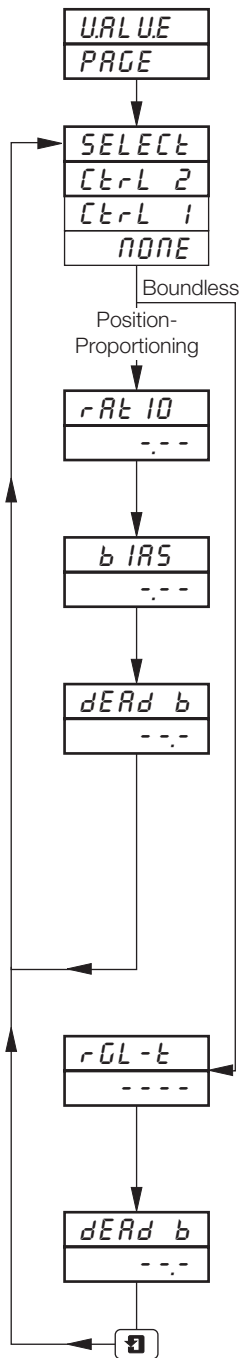

Page Header – Valve Page.

To advance to **Set Up Control Page** press the key.

Select Controller

Select the controller to be programmed (1 or 2).

Note. In the remaining frames press the key to view the controller selected.

Ratio

The Ratio is a scaling factor, i.e. multiplies the position feedback input by the value set here.

Set the required feedback ratio, between 0.01 and 10.00 in 0.01 increments.

Bias

The Bias is an offset set as a percentage of the display full scale.

Set the required feedback bias, between –100.0 and +100.0% in 0.1% increments.

Dead Band

Deadband is set as a percentage of the position feedback span, between 0.0 and 10.0%, to produce a deadband around the valve control value. This gives minimum 'hunting' of the motorized valve.

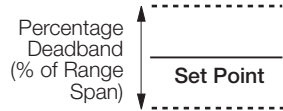

Example – if the valve is to be driven to 50% open position and the deadband is set to 4.0%, the motor stops driving when the position feedback is 48%. The deadband is between 48% and 52%.

Return to **Select Controller** frame.

Regulator Travel Time

This is the time set for the regulator to travel from the fully open to the fully closed position or from the fully closed to the fully open position.

Set the value required in seconds, between 1 and 5000 seconds.

Dead Band

Deadband is set as a percentage of the engineering range. Set a value which gives minimum hunting of the regulator, between 0.0 and 10.0 in 0.1% increments.

Return to **Select Controller** frame.

4.2.4 Calculation for Control Pulses, Steps and Deviation (Boundless Control only)

Minimum 'ON' time of integral action pulses (for a fixed control deviation)

$$= \frac{\text{Travel Time} \times \text{Deadband \%}}{\%PB} \text{ (in seconds)}$$

Duration of the proportional step

$$= 2 \times \left[\frac{\% \text{ Control Deviation}}{\% \text{ Proportional Band}} \right] \times \text{Travel Time (in seconds)}$$

Minimum (approximate) time between integral action pulses (for a fixed control deviation)

$$= \frac{\text{Integral Action Time} \times \text{Deadband \%}}{2 \times \text{Control Deviation}} \text{ (in seconds)}$$

% Control Deviation

$$= \frac{\text{Set Point} - \text{Process Variable}}{\text{Span}} \times 100\%$$

4.3 Set Up Control

Information.

- **Control types** – Current Proportioning, Time Proportioning (and On/Off), Position-proportioning (motorized valve control with feedback), Boundless and Heat/Cool.
- **Programmable power-up control modes and outputs.**
- **Reverse and direct control actions.**
- **High and low output limits.**
- **Programmable fault actions** – enable fault actions on any of the inputs (process variable, remote set point and position feedback) to be controlled.

4.3.1 Set Up Control Page (control type)

```
SET UP
ContrL
```

Page Header – Set Up Control.

```
SELECT
Ctrl 2
Ctrl 1
NONE
```

Select Controller

Select the controller to be programmed (1 or 2).

Note. In the remaining frames press the ***** key to view the controller selected.

```
C-TYPE
bndLSS
P-PrOP
Ht-CL
Std
```

Control Type

Select the control type required:

- bndLSS* – (Boundless) for motorized valve control, without position feedback
- P-PrOP* – (Position-Proportioning) motorized valve control, with position feedback
- Ht-CL* – (Heat/Cool) dual output control
- Std* – (Standard) current proportioning, time proportioning and on/off

```
PF_0dE
-----
```

Continued on page 39.

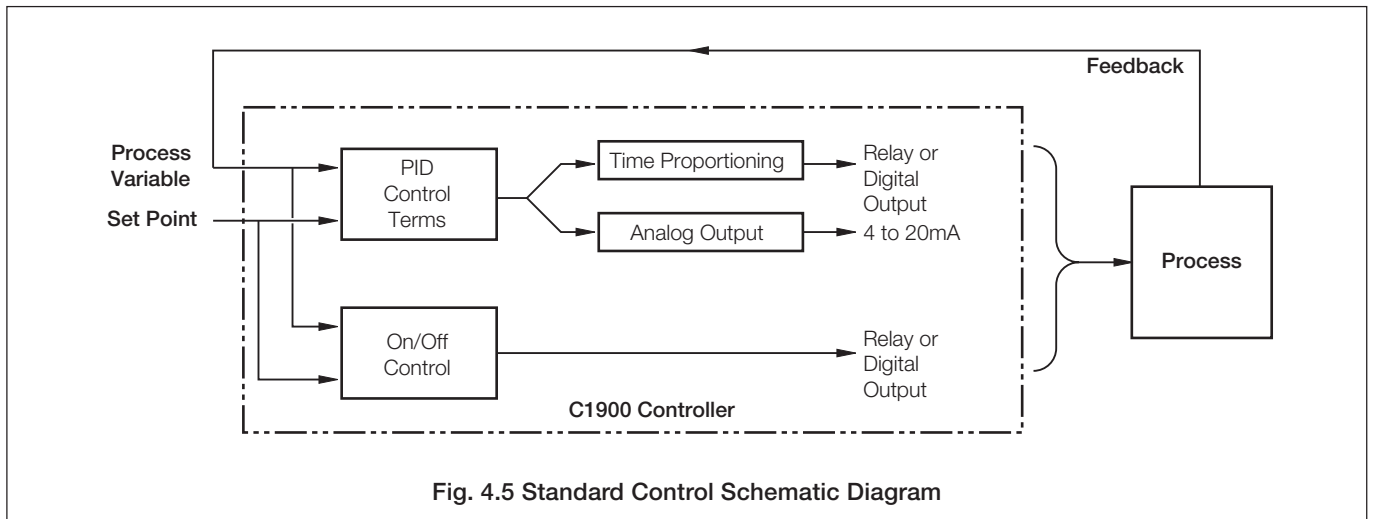
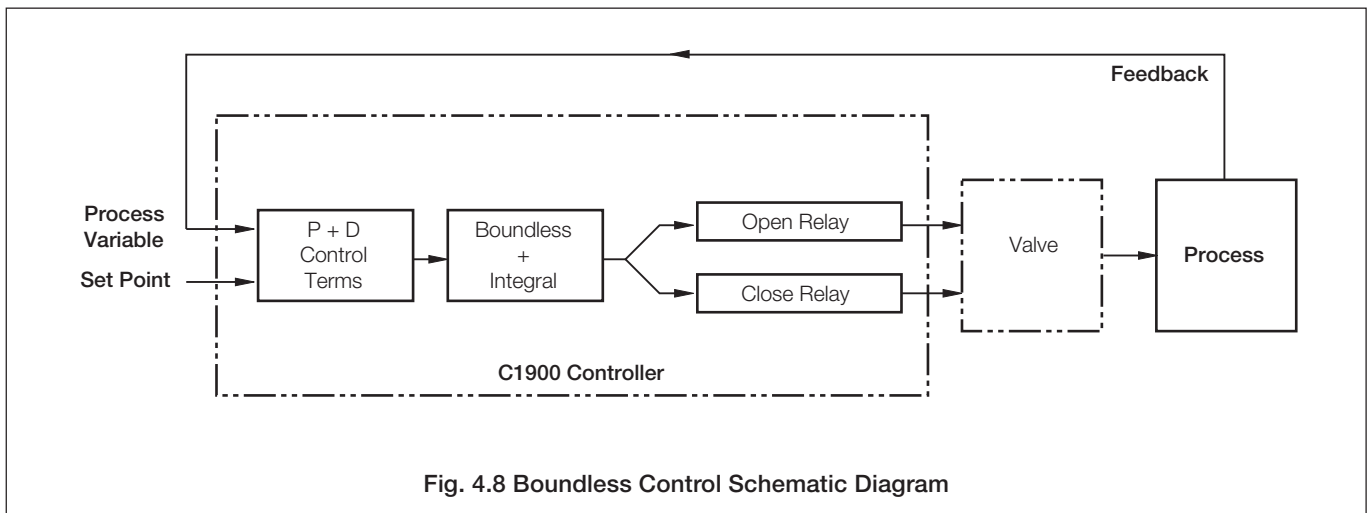
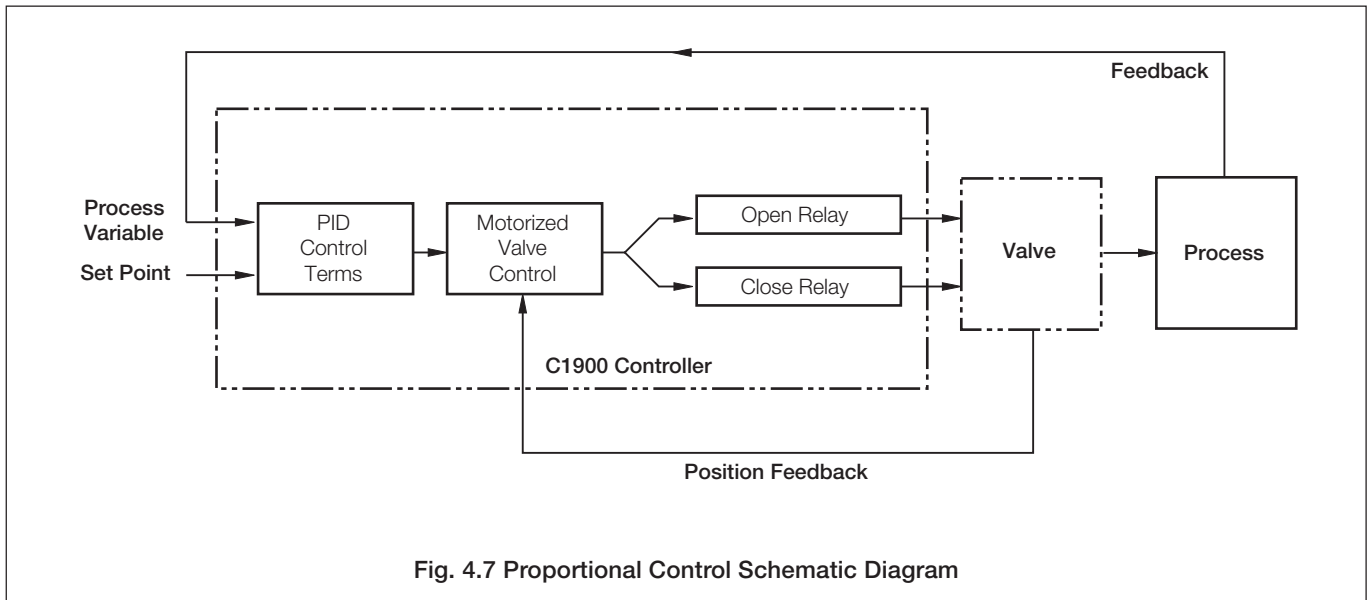
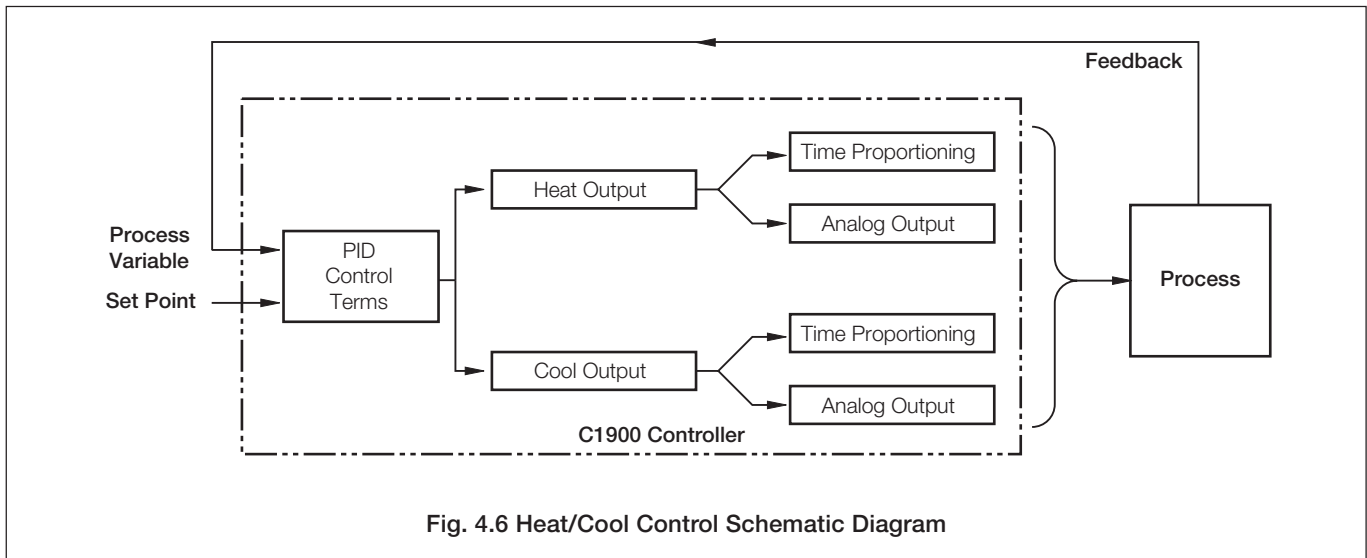

Fig. 4.5 Standard Control Schematic Diagram

...4.3.1 Set Up Control Page (control type)



4.3.2 Set Up Control Page (power-fail mode)

Information.

- Programmable power-up mode.
- Programmable output (or valve position) values.

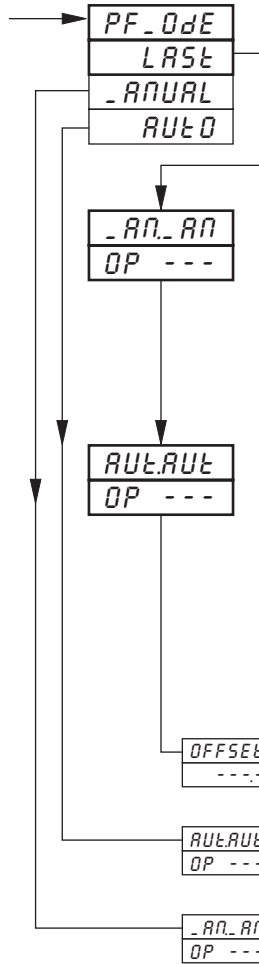

Power Failure Mode

Select the default power fail mode required following a power interruption or failure:

- LAST* – restart in the **same mode** existing prior to power failure.
- _ANUAL* – restart in **Manual mode**.
- AUTO* – restart in **Auto mode**.

Manual-to-Manual Power Fail Output:

is the control output value required when power-down state is Manual and power-up state is Manual.

Set the control output value (or valve position) required following a power failure, between 0 and 100% in increments of 1%, or *LAST*. If *LAST* is selected the percentage control output present prior to the power failure is retained.

Auto-to-Auto Power Fail Output:

is the control output value required when power-down state is Auto and power-up state is Auto.

On power-up the controller presets the Integral component to give bumpless operation on power-up, at the selected output value, using the current process variable and set point values. If *AUTO* is selected the Integral component is not preset.

Set the control output value (or valve position) required following a power failure, between 0 and 100% in increments of 1%, or *LAST*.

Continued on page 41.

Continued on next page.

Continued on next page.

Power Fail Mode	Mode on Power Down	Mode on Power Up	Control Output (Valve Position) on Power Up
Auto	Auto	Auto	Integral component of the control output is preset to give bumpless operation at power-up at the value set in the Auto-to-Auto frame.
	Manual	Auto	Integral component of the control output is preset to give bumpless operation at power-up at the value set in the Manual-to-Auto frame (or LAST)
Manual	Auto	Manual	Value set in Auto-to-Manual Output frame (or LAST)
	Manual	Manual	Value set in Manual-to-Manual Output frame or output value prior to power-down (if LAST selected)
Last	Auto	Auto	Integral component of the control output is preset to give bumpless operation at power-up at the value set in the Auto-to-Auto frame (or LAST)
	Manual	Manual	Value set in Manual-to-Manual Output frame or output value prior to power-down (if LAST selected)

Table 4.1 Power-up and Power-down Control Modes

...4 CONTROL CONFIGURATION LEVEL

...4.3.2 Set Up Control Page (power-fail mode)

MANUAL

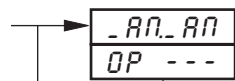

Manual-to-Manual Power Fail Output:

is the control output value required when power-down state is Manual and power-up state is Manual.

Set the control output value (or valve position) required following a power failure, between 0 and 100% in increments of 1%, or *LASE*. If *LASE* is selected the percentage control output present prior to the power failure is retained.

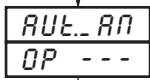

Auto-to-Manual Power Fail Output:

is the control output value required when power-down state is Auto and power-up state is Manual.

Set the control output value (or valve position) required following a power failure, between 0 and 100% in increments of 1%.



Continued on next page.

AUTO



Auto-to-Auto Power Fail Output:

is the control output value required when power-down state is Auto and power-up state is Auto.

On power-up the controller presets the Integral component to give bumpless operation on power-up, at the selected output value, using the current process variable and set point values. If *AUTO* is selected the Integral component is not preset.

Set the control output value (or valve position) required following a power failure, between 0 and 100% in increments of 1%, or *AUTO*.



Manual-to-Auto Power Fail Output:

is the control output value required when power-down state is Manual and power-up state is Auto.

On power-up the controller presets the Integral component to give bumpless operation on power-up, at the selected output value (or output prior to power-down, if *LASE* is selected), using the current process variable and set point values. If *AUTO* is selected the Integral component is not preset.

Set the control output value (or valve position) required following a power failure, between 0 and 100% in increments of 1%, or *AUTO*.



Continued on next page.

4.3.3 Set Up Control Page (control actions and limits – non heat/cool)

Information.

- Two control offsets.
- Programmable control actions for all outputs.
- High/low output (or valve position) limits, when in auto control mode.

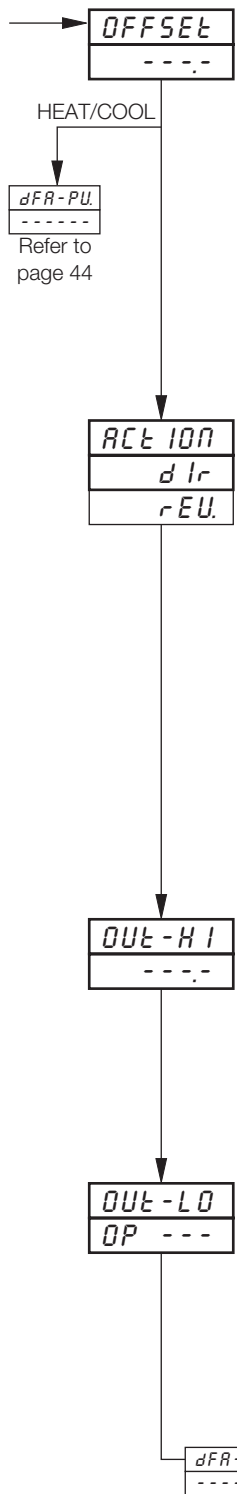

Control Offset

Select the offset required, 0 or 50%.

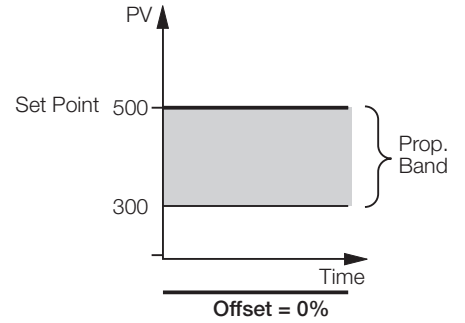
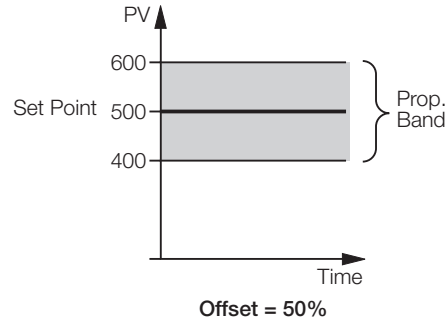

Control Action

Select the action for the PID control output.

- d lr* – direct acting
- rEU.* – reverse acting

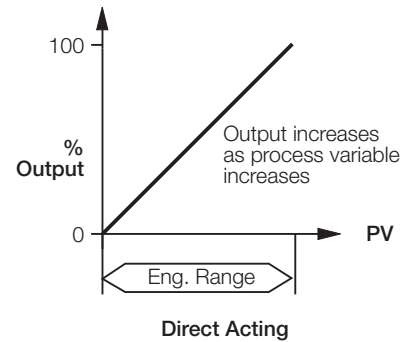
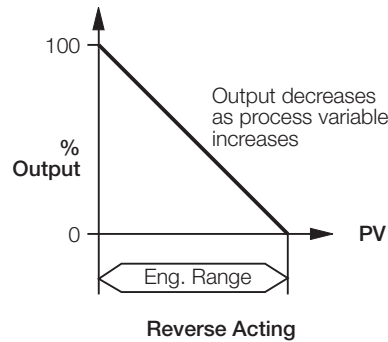

Output High Limit:

limits the high level of the control output value (or valve position) when in automatic mode. If the control output is above this limit when automatic mode is selected, the output is allowed to stay at its current level but is not allowed to go any higher. Once the control output returns to, or below, this limit the limit then applies. When the controller is in manual mode the output limits do not apply.

Select the output high limit value (or valve position) required, between 0.0 and 100.0 in 0.1 increments.

Output Low Limit:

limits the low level of the control output value (or valve position) when in automatic mode. If the control output is below this limit when automatic mode is selected, the output is allowed to stay at its current level but is not allowed to go any lower. Once the control output returns to, or above, this limit the limit then applies. When the controller is in manual mode the output limits do not apply.

Select the output low limit value (or valve position) required, between 0.0 and 100.0 in 0.1 increments.

Continued on page 44.

4.3.4 Set Up Control Page (control actions and limits – heat/cool)

Information.

- Independently programmable control actions for heat and cool outputs – direct or reverse.
- Output limits for heat and cool outputs.

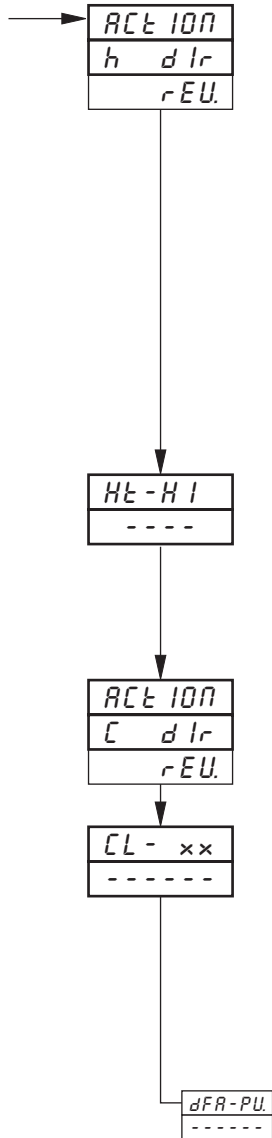

Control Action (Heat)

Select the action for the heat and PID control outputs:

- h dlr* – direct acting
- rEU.* – reverse acting.

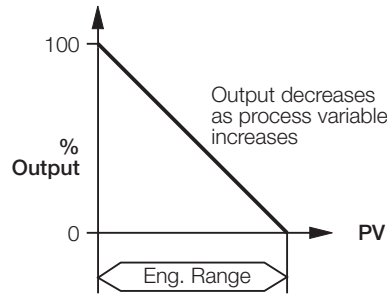

Reverse Acting

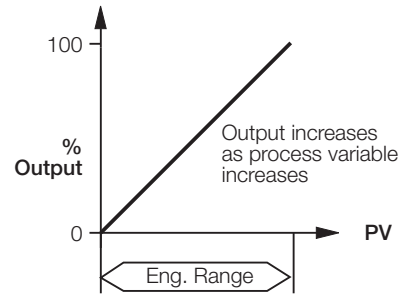

Direct Acting

Heat Output High Limit:

limits the high level of the heat control output value when in automatic mode. If the control output is above this limit when automatic mode is selected, the output is allowed to stay at its current level but is not allowed to go any higher. Once the control output returns to, or below, this limit the limit then applies. When the controller is in manual mode the output limits do not apply. Select the heat output high limit value required, between 0.0 and 100.0 in 0.1 increments.

Control Action (Cool)

Select the action for the cool control output (see also **Control Action (Heat)**, above):

- C dlr* – direct acting
- rEU.* – reverse acting.

Cool Output High/Low Limit:

limits the high or low level of the cool control output when in automatic mode, depending on the Control Action (Cool) setting (*rEU.* is the low and *dlr* is the high setting). If the control output exceeds this limit when automatic mode is selected, the output remains at its current level but is not allowed to go any further away from the limit. Once the control output returns to, or within, this limit, the limit then applies. When the controller is in manual mode the output limits do not apply. Select the cool output high (low) limit required, between 0.0 and 100.0 in 0.1 increments.

Continued on next page.

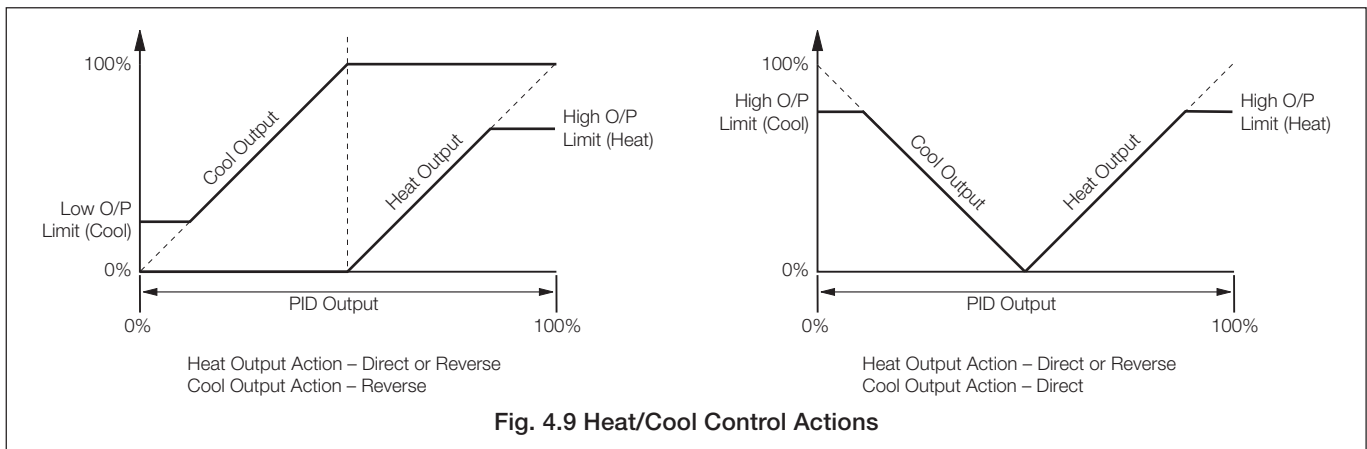
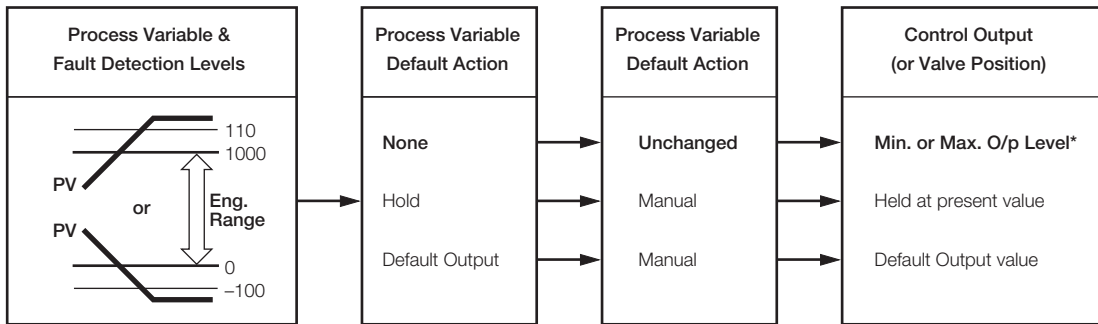

Fig. 4.9 Heat/Cool Control Actions

4.3.5 Set Up Control Page (default control actions)

Information. Programmable default control action if input exceeds fault levels – independently programmable for all inputs (process variable, remote set point and position feedback).

Examples show fault detection levels of 10%



* Controller output is driven to either the maximum or minimum output limit, depending on the **Broken Sensor Protection Drive** setting– see **Set Up Inputs Page, BASIC CONFIGURATION LEVEL.**

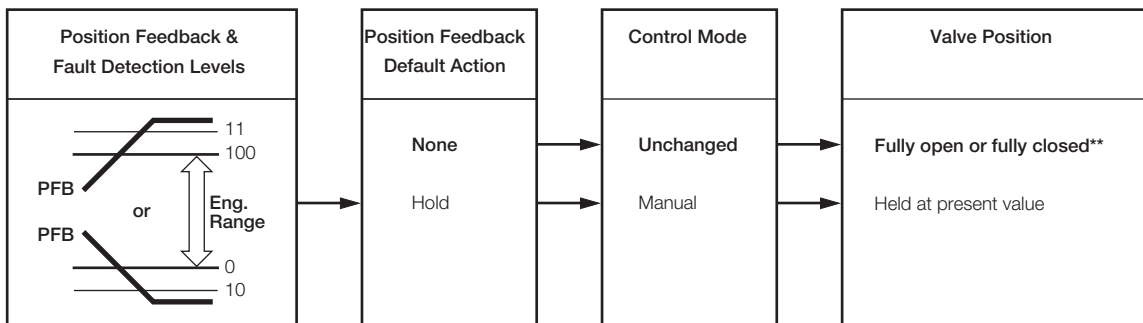
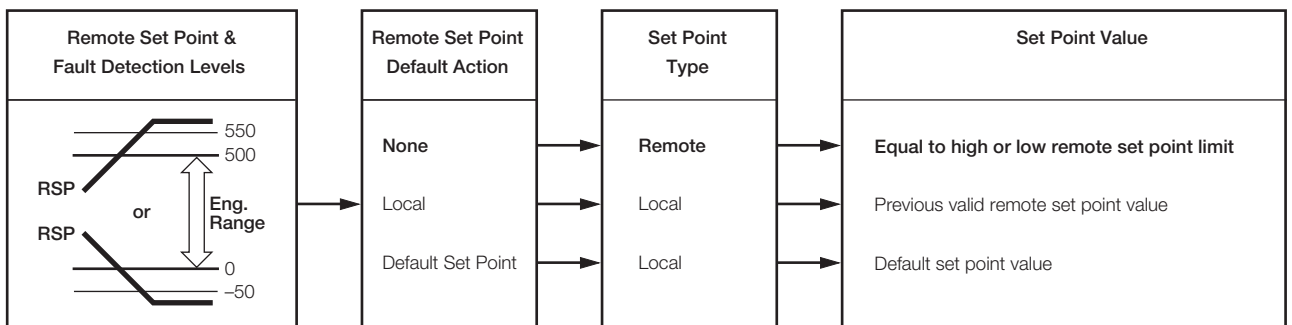

** Valve is driven to either fully open or fully closed, depending on the **Broken Sensor Protection Drive** setting– see **Set Up Inputs Page, BASIC CONFIGURATION LEVEL.**

Fig. 4.10 Default Control Actions for Input Fault Detection Levels

...4 CONTROL CONFIGURATION LEVEL

...4.3.5 Set Up Control Page (default control actions)

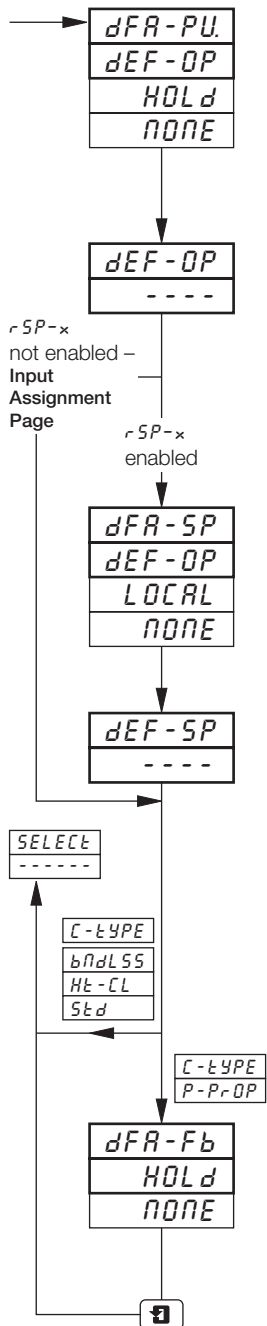

Default Action (Process Variable)

Select the default control action required if the process variable exceeds its fault detection level (set in the **Set Up Input Page, BASIC CONFIGURATION LEVEL**):

- dEF-OP* – revert to manual control mode and change the control output to the **Default Output** value (see next frame).
- HOLD* – revert to manual control mode and hold the output at its current value.
- NONE* – no action.

Default Output

Set the default control output value used if the process variable exceeds the fault detection level (between 0 and 100% in 1 % increments).

Note. For boundless motorized valve control, the default output setting can be only 0 or 100%.

Default Action (Set Point)

Select the default control action required if the remote set point exceeds its fault detection level (set in the **Set Up Input Page, BASIC CONFIGURATION LEVEL**):

- dEF-SP* – revert to local set point and use the **Default Set Point** value (see next frame).
- LOCAL* – revert to local set point.
- NONE* – no action.

Default Set Point

Set the default control set point value used if the remote set point exceeds the fault detection level (in engineering units).

Default Action (Position Feedback)

Select the default control action required if the position feedback exceeds its fault detection level (set in the **Set Up Input Page, BASIC CONFIGURATION LEVEL**):

- HOLD* – revert to manual control mode and hold the valve at its current position.
- NONE* – no action.

Return to **Select Controller** frame.

4.4 Set Up Operating Page

Information.

- Customized display of parameters in the Operating Page.
- Power-fail indication – if enabled, *L INE FR ILEd* is displayed to indicate that a power failure has occurred.
- Auto/Manual key – enable or disable.

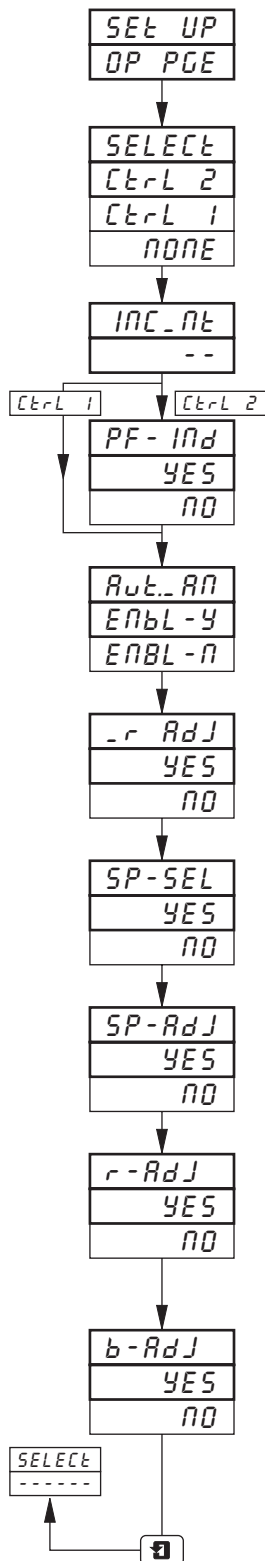

Page header – **Set Up Operating Page.**

To advance to **Set Up Digital Page** press the key.

Select Controller

Select the controller to be programmed (1 or 2).

Note. In the remaining frames press the key to view the controller selected.

Bargraph Increment

The deviation from set point is shown on the bargraph on the faceplate.
Set the percentage deviation represented by each bar, between 1 and 10% in 1% increments.

Power Fail Indication Enable

Enable or disable power failure indication:
YES – enable
NO – disable

Auto/Manual Select Enable

Enable or disable the key on the faceplate:
ENBL-Y – enable
ENBL-N – disable

Manual Reset Adjustment Enable

Enable or disable display and adjustment of the **Manual Reset** frame in the **Operating Page**:
YES – enable
NO – disable

Set Point Select Enable

Enable or disable adjustment of the **Set Point Type Selection** frame in the **Operating Page**:
YES – enable
NO – disable

Set Point Adjust Enable

Enable or disable adjustment of the **Control Set Point** value in the **Operating Page**:
YES – enable
NO – disable

Remote (or Cascade) Set Point Ratio Adjust Enable

Enable or disable display and adjustment of the **Remote (or Cascade) Set Point Ratio** in the **Operating Page**.
YES – enable
NO – disable

Remote (or Cascade) Set Point Bias Adjust Enable

Enable or disable display and adjustment of the **Remote (or Cascade) Set Point Bias** in the **Operating Page**.
YES – enable
NO – disable

Return to **Select Controller** frame.

4.5 Set Up Digital Page

Information.

- Digitally selectable control modes and set point types.
- Up to 3 digitally selectable local set points.
- Digital signal sources – can be from external digital inputs, internal alarms, logic equations, control modes, ramp/soak events or totalizer signals.

Note.

- The complete list of digital sources is shown in Table 3.1 on page 18.
- Digital sources can be either leading edge triggered or level triggered, depending on the parameter function (single or dual).

Single function parameters, e.g. set point 1 selection, are **leading edge triggered**, i.e. the active logic state can be removed after the function is selected.

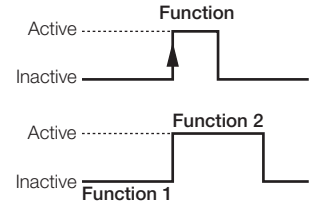

Dual function parameters, e.g. auto/manual control mode selection, are **level triggered**, i.e. the active logic state must be maintained to select the alternative function.

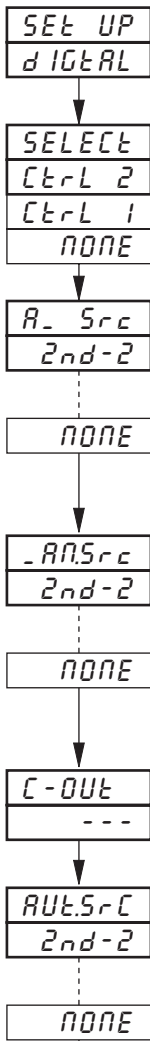

Page header – Set Up Digital.

To advance to **Control Configuration Level** frame press the key.

Select Controller

Select the controller to be programmed (1 or 2).

Note. In the remaining frames press the key to view the controller selected.

Auto/Manual Control Mode Source

Select a source to switch between Auto and Manual control modes. When Manual control mode is selected, the output reverts automatically to the value set in the **Configured Output** frame (see below).

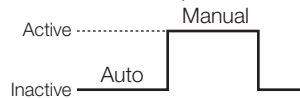

Manual Control Mode Source

Select a source to switch to Manual control mode. When Manual control mode is selected, the output reverts automatically to the value set in the **Configured Output** frame (see below).

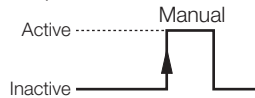

Configured Output

Set the control output value required when Manual control mode is selected.

Auto Control Mode Source

Select a source to switch to Auto control mode.

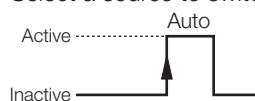

Continued on next page.

4.6 Set Up Digital Inputs

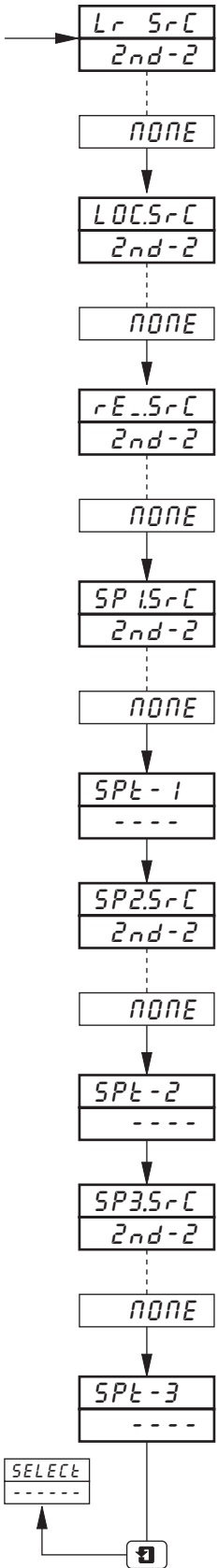

Local/Remote (or Dual) Set Point Source
 Select a source to switch between Local and Remote set points.

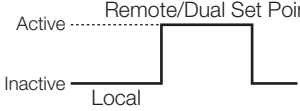

Local Set Point Source
 Select a source to switch to the Local set point.

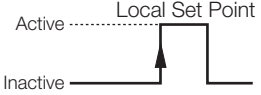

Remote/Dual Set Point Source
 Select a source to switch to the Remote set point.

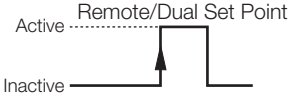

Set Point 1 Source
 Select a source to make the Local set point value equal to Set Point 1.

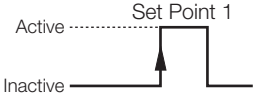

Set Point 1 Value
 Set the Set Point 1 value.

Set Point 2 Source
 Select a source to make the Local set point value equal to Set Point 2.

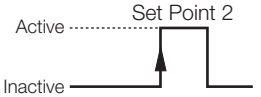

Set Point 2 Value
 Set the Set Point 2 value.

Set Point 3 Source
 Select a source to make the Local set point value equal to Set Point 3.

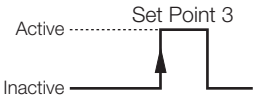

Set Point 3 Value
 Set the Set Point 3 value.

Return to **Select Controller** frame.

5 ADVANCED CONFIGURATION LEVEL

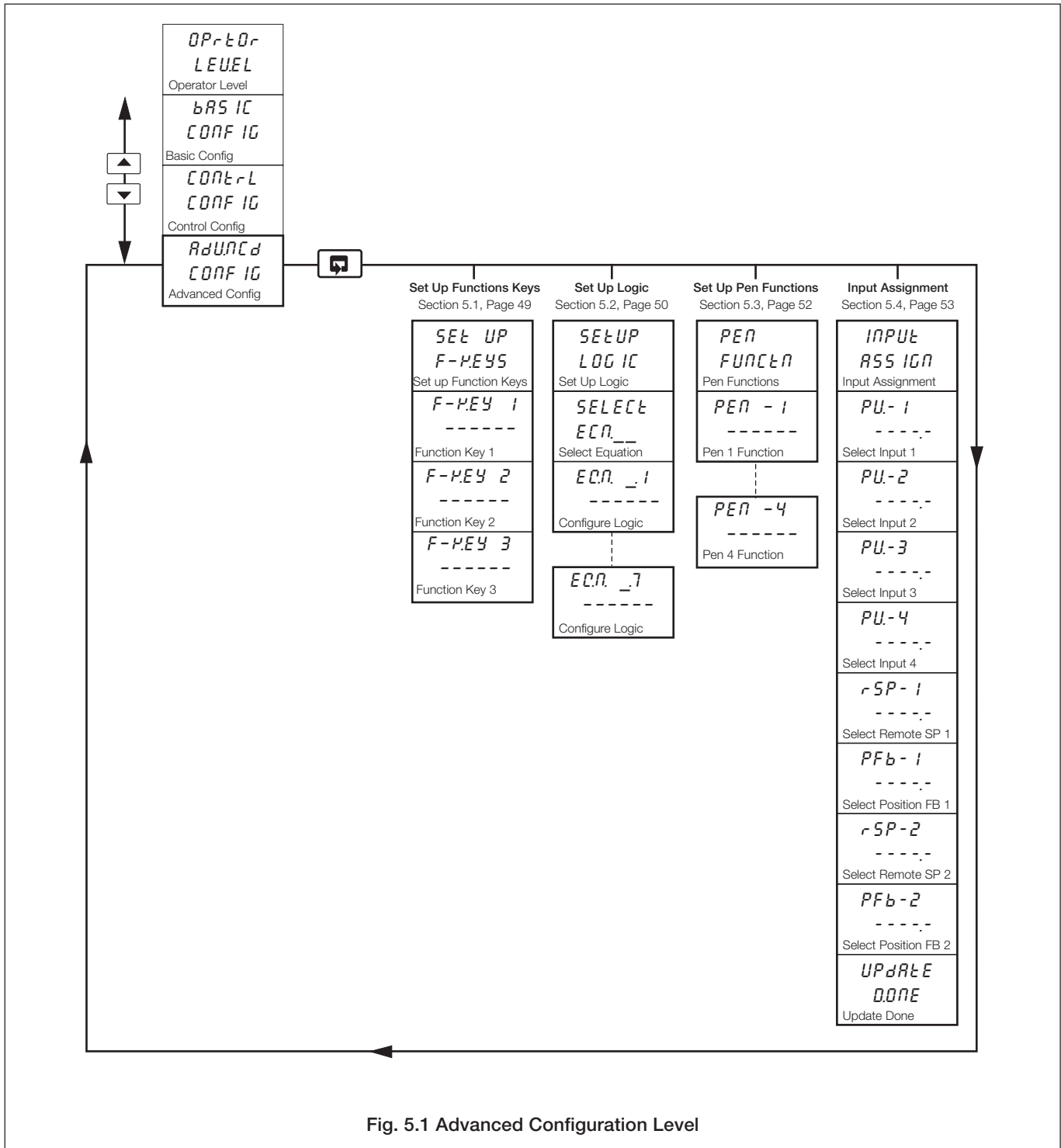
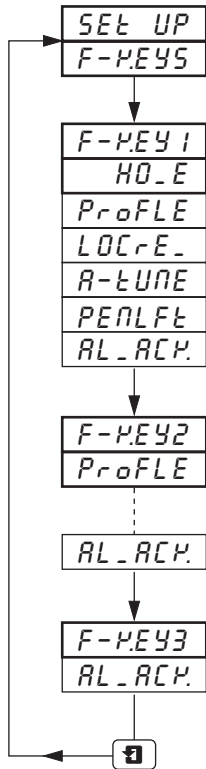

Fig. 5.1 Advanced Configuration Level

5.1 Set Up Function Keys

Information.

- **Programmable function key** – on each faceplate.
- **Home function** – returns the instrument display to the start of the **Operating Page** when at the top of any page.
- **Global alarm acknowledge function** – acknowledges any unacknowledged alarms on all channels.
- **Penlift function** – raises and lowers pens (for use on controller faceplates which do not have a dedicated penlift key).
- **Local/Remote set point selection.**
- **Quick access to auto-tuning** – reverts to the top of the **Auto-tuning Page**.
- **Quick access to profile operator controls** – reverts to the top of the **Profile Control Page**.



Page Header – **Set Up Function Keys**

To advance to the **BASIC CONFIGURATION LEVEL** frame press the key.

Function Key 1

Select function required.

- HO-E* – home (return to **Operating Page** in the **OPERATOR LEVEL**)
- PROFLE* – revert to top of **Profile States Page**
- LOCrE_* – local/remote set point selection
- A-tUNE* – auto tune (reverts to top of **Auto Tune Page** in the **OPERATOR LEVEL**)
- PENLFL* – pen lift/drop (lifts and lowers pens)
- AL-ACP.* – acknowledge alarm

Function Key 2

Select function required (if applicable).

Function Key 3

Select function required (if applicable).

Return to **Set Up Function Keys** frame.

5.2 Set Up Logic

Information.

- 8 logic equations.
- 7 elements per equation.
- OR/AND operators.
- Can combine internal and external digital signals – i.e. alarms, digital inputs, other logic equation results, real time events (if timer option is fitted), control modes set point modes and profile segments and programs (if option is fitted).

For each equation, the logic elements 1 to 7 are arranged sequentially, as shown. Odd numbered elements are used for logic inputs and even numbered elements for logic gates.

Logic inputs must be set to one of the digital sources listed in Table 3.1 on page 18.

Logic gates must be set to *AND*, *OR* or *END*. Setting an element to *END* terminates the equation.

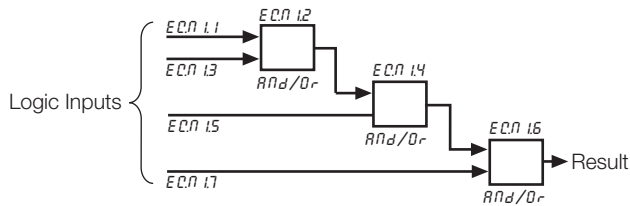

Note. Elements on each equation are calculated sequentially, i.e. elements 1, 2 and 3 are evaluated first and this result is then combined with elements 4 and 5. Similarly, this resultant is then combined with elements 6 and 7 to give the logic equation result.

Example – Reservoir level monitoring using:

- process variable 1 with an engineering range 0 to 100 feet
- logic equation 1 result assigned to relay 1.1 which is used to operate the control valve.

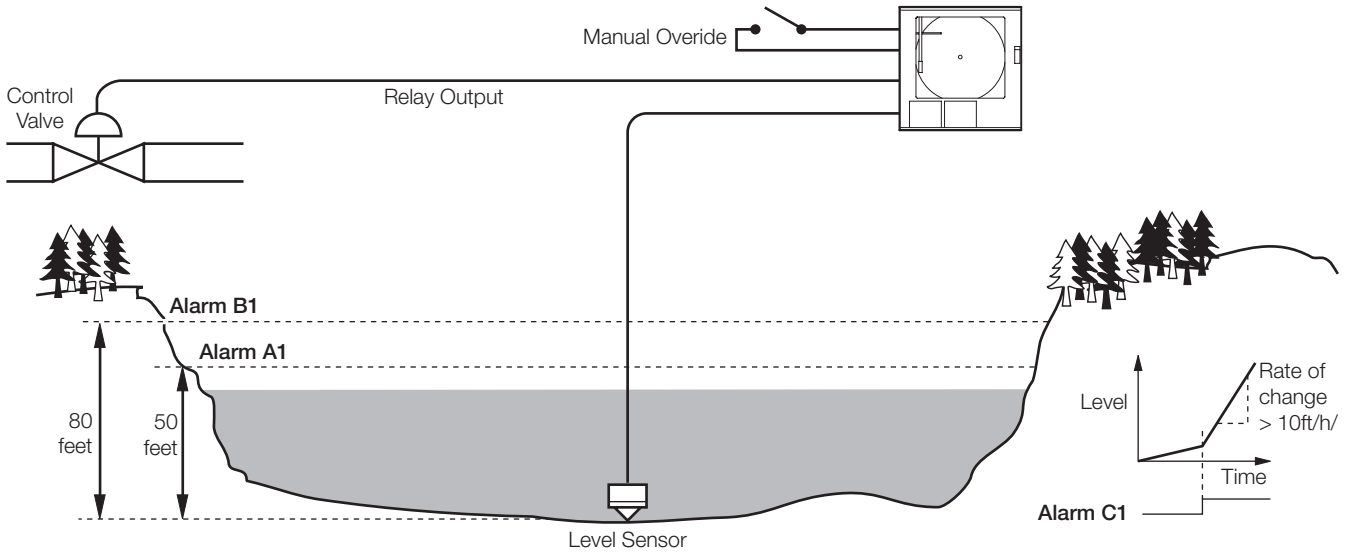

Flow Conditions
Close reservoir control valve if:
• Reservoir level >50 feet AND rate of change >10 ft/hr
OR
• Reservoir level >80 ft
OR
• Manual override switch operated

Input Elements
• Alarm A1 – set to high process trip at 50 ft
• Alarm B1 – set to high process trip at 80 ft
• Alarm C1 – set to fast rate trip at 10% of range per hour (10 ft/hr)
• Manual override switch:
Connected to digital input 1.1
Digital input number <input type="text"/>
Module number <input type="text"/>
Negative polarity <input type="checkbox"/>
Volt-free switching <input type="checkbox"/>

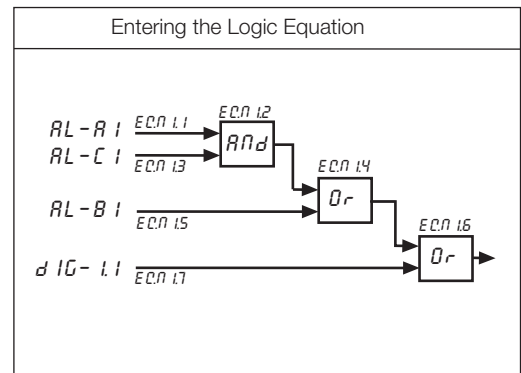

...5.2 Set Up Logic

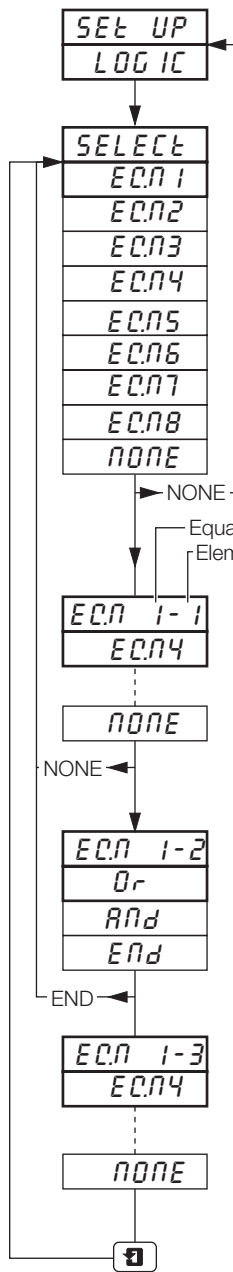

Page Header – Set Up Logic

To advance to **Set Up Pen Functions Page** press the **key**.

Select Equation

Select equation to be constructed.

Note. In the remaining frames press the ***** key to view the equation selected.

Equation n/Element 1

Select the source required for element 1.

For description of sources, refer to **Table 3.1** on page 18.

Equation n/Element 2

Select the operator required to combine elements 1 and 3:

- Or* – Or
- And* – And
- End* – Ends equation

Equation n/Element 3

Repeat previous two steps for elements 3 to 7.

- Odd numbered elements = sources
- Even numbered elements = operators

Return to **Select Equation** frame.

5.3 Set Up Pen Functions

Information. Any fitted pen can be assigned to a trend or an event function.

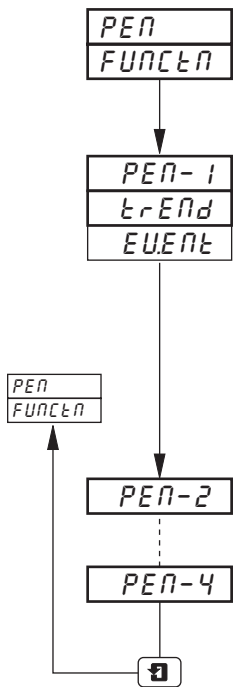

Page Header – Pen Functions

To advance to **Advanced Configuration** frame press the key.

Pen 1

Select pen function required:

- TREND* – Trend pen
- EVENT* – Event pen

Note. The event pen and true time line event pen are separate functions and only the event pen can be selected in this page. The true time line event pen option allows marking on the same time line as the red pen and requires a special pen arm and motor assembly. Refer to the order code in the **Specification Sheet**.

Pens 2 to 4

Repeat as for **Pen 1**, if applicable.

Return to **Pen Function** frame.

5.4 Input Assignment

Information. Assignment Process Variables, Remote Set Points and Position Feedbacks – can all be assigned to any analog input or math block result (if fitted).

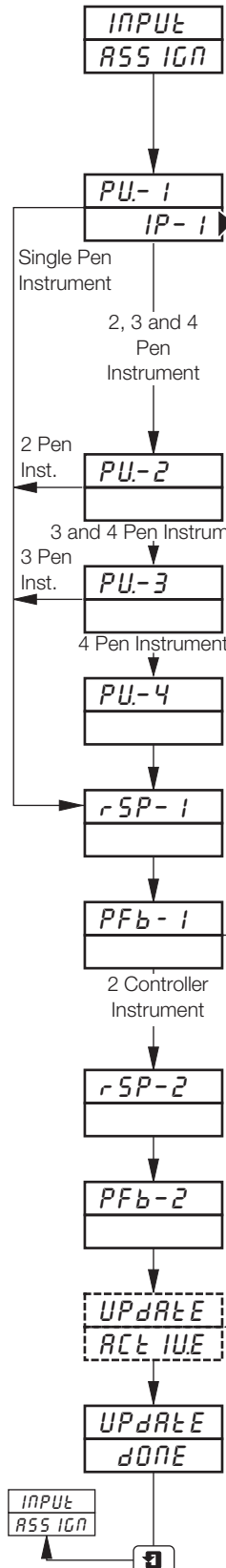

Page Header – Input Assign

Note. Entry and access to and from this page can only be implemented from the page header.

To advance to **ADVANCED CONFIGURATION LEVEL** frame press the key.

Process Variable 1

Select analog input or math block result for Process Variable 1.

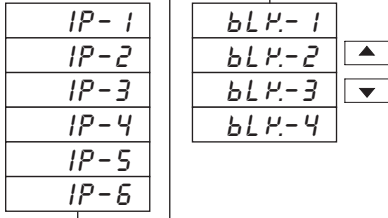

IP-1 to *IP-6* – analog input 1 to 6 (if available)
bLP-1 to *bLP-4* – math block 1 to 4 (if available)

Process Variable 2

Select analog input or math block result for Process Variable 2 – see *PU-1* for description of inputs and math blocks.

Process Variable 3

Select analog input or math block result for Process Variable 3 – see *PU-1* for description of inputs and math blocks.

Process Variable 4

Select analog input or math block result for Process Variable 4 – see *PU-1* for description of inputs and math blocks.

Remote Set Point (Controller 1)

Select analog input or math block result for remote set point for Controller 1 – see *PU-1* for description of inputs and math blocks.

Position Feedback (Controller 1)

Select analog input or math block result for position feedback for Controller 1 – see *PU-1* for description of inputs and math blocks.

Remote Set Point (Controller 2)

Select analog input or math block result for remote set point for Controller 2 – see *PU-1* for description of inputs and math blocks.

Position Feedback (Controller 2)

Select analog input or math block result for position feedback for Controller 2 – see *PU-1* for description of inputs and math blocks.

Update Active/Done

The *ACT IVE* frame is displayed momentarily as any changes are stored in the non-volatile memory. *DONE* is displayed on completion.

Return to **Input Assign** frame.

Main Input, Standard Input & Analog + Relay

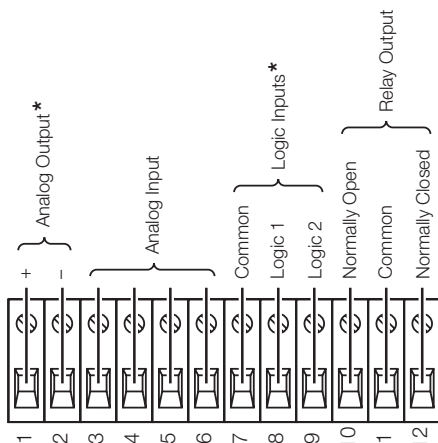

* Not fitted on Analog + Relay Module

4 Relays Module

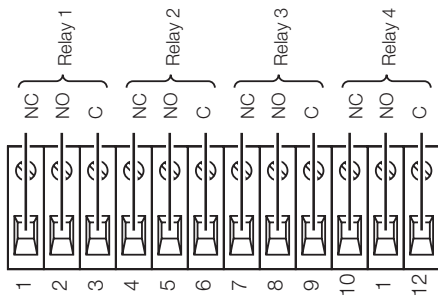

8 Digital Inputs/Outputs Module

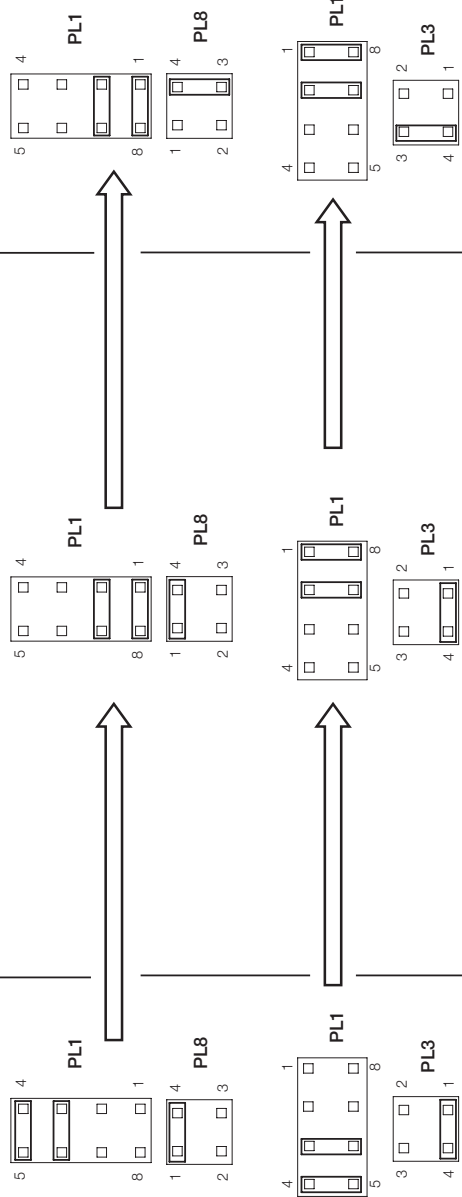
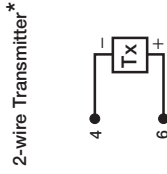
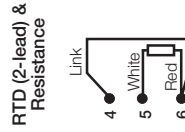
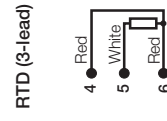
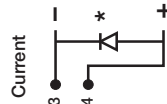
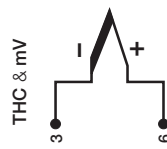
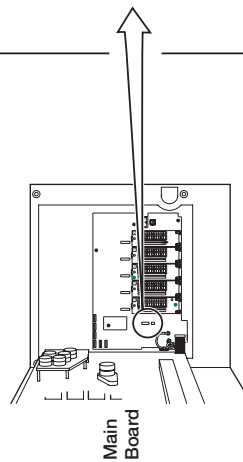
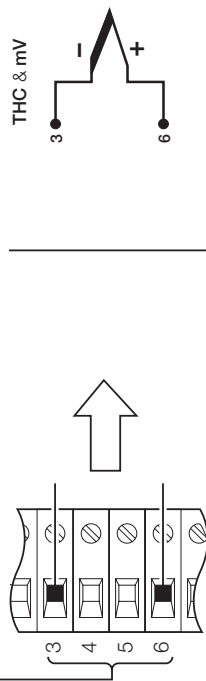
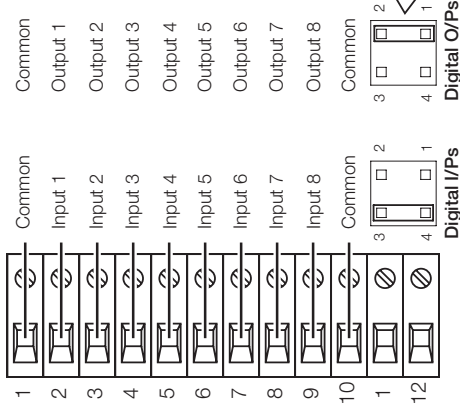

* **Recommended Diode:** Diode forward voltage > 0.8 V @ 20 mA or use 2 x 1N4001 general purpose diodes in series.

NOTES

Products and customer support

Automation Systems

For the following industries:

- Chemical & Pharmaceutical
- Food & Beverage
- Manufacturing
- Metals and Minerals
- Oil, Gas & Petrochemical
- Pulp and Paper

Drives and Motors

- AC and DC Drives, AC and DC Machines, AC Motors to 1kV
- Drive Systems
- Force Measurement
- Servo Drives

Controllers & Recorders

- Single and Multi-loop Controllers
- Circular Chart and Strip Chart Recorders
- Paperless Recorders
- Process Indicators

Flexible Automation

- Industrial Robots and Robot Systems

Flow Measurement

- Electromagnetic Flowmeters
- Mass Flowmeters
- Turbine Flowmeters
- Wedge Flow Elements

Marine Systems & Turbochargers

- Electrical Systems
- Marine Equipment
- Offshore Retrofit and Refurbishment

Process Analytics

- Process Gas Analysis
- Systems Integration

Transmitters

- Pressure
- Temperature
- Level
- Interface Modules

Valves, Actuators and Positioners

- Control Valves
- Actuators
- Positioners

Water, Gas & Industrial Analytics Instrumentation

- pH, Conductivity and Dissolved Oxygen Transmitters and Sensors
- Ammonia, Nitrate, Phosphate, Silica, Sodium, Chloride, Fluoride, Dissolved Oxygen and Hydrazine Analyzers
- Zirconia Oxygen Analyzers, Katharometers, Hydrogen Purity and Purge-gas Monitors, Thermal Conductivity

Customer support

We provide a comprehensive after sales service via a Worldwide Service Organization. Contact one of the following offices for details on your nearest Service and Repair Centre.

UK

ABB Limited
Tel: +44 (0)1453 826661
Fax: +44 (0)1453 829671

USA

ABB Inc.
Tel: +1 215 674 6000
Fax: +1 215 674 7183

Client Warranty

Prior to installation, the equipment referred to in this manual must be stored in a clean, dry environment, in accordance with the Company's published specification. Periodic checks must be made on the equipment's condition. In the event of a failure under warranty, the following documentation must be provided as substantiation:

- A listing evidencing process operation and alarm logs at time of failure.
- Copies of all storage, installation, operating and maintenance records relating to the alleged faulty unit.

Contact us

To find your local ABB contact visit:

www.abb.com/contacts

For more product information visit:

www.abb.com

Note

We reserve the right to make technical changes or modify the contents of this document without prior notice. With regard to purchase orders, the agreed particulars shall prevail. ABB does not accept any responsibility whatsoever for potential errors or possible lack of information in this document.

We reserve all rights in this document and in the subject matter and illustrations contained therein. Any reproduction, disclosure to third parties or utilization of its contents in whole or in parts - is forbidden without prior written consent of ABB.

Copyright© 2010 ABB

All rights reserved

IM/C/1900-PGC Rev. J 10.2010