

COMMANDER 200
Process Controller

Operating Instructions

Ramp/Soak
Totalization Supplement



ABB Instrumentation



ABB KENT-TAYLOR

The Company

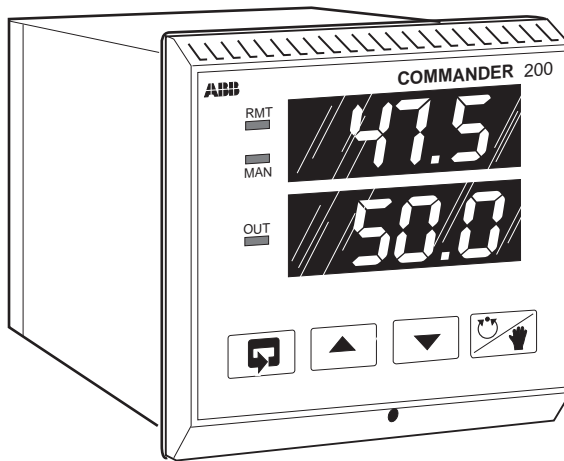
ABB Kent-Taylor is an established world force in the design and manufacture of instrumentation for industrial process control, flow measurement, gas and liquid analysis and environmental applications.

As a part of ABB, a world leader in process automation technology, we offer customers application expertise, service and support worldwide.

We are committed to teamwork, high quality manufacturing, advanced technology and unrivalled service and support.

The quality, accuracy and performance of the Company's products result from over 100 years experience, combined with a continuous program of innovative design and development to incorporate the latest technology.

The NAMAS Calibration Laboratory No. 0255(B) is just one of the ten flow calibration plants operated by the Company, and is indicative of ABB Kent-Taylor's dedication to quality and accuracy.

BS EN ISO 9001



St Neots, U.K. – Cert. No. Q5907

Stonehouse, U.K. – Cert. No. FM 21106

EN 29001 (ISO 9001)



Lenno, Italy – Cert. No. 9/90A



Stonehouse, U.K. – Cert. No. 0255

Use of Instructions



Warning.

An instruction that draws attention to the risk of injury or death.



Caution.

An instruction that draws attention to the risk of damage to the product, process or surroundings.



Note.

Clarification of an instruction or additional information.



Information.

Further reference for more detailed information or technical details.

Although **Warning** hazards are related to personal injury, and **Caution** hazards are associated with equipment or property damage, it must be understood that operation of damaged equipment could, under certain operational conditions, result in degraded process system performance leading to personal injury or death. Therefore, comply fully with all **Warning** and **Caution** notices.

Information in this manual is intended only to assist our customers in the efficient operation of our equipment. Use of this manual for any other purpose is specifically prohibited and its contents are not to be reproduced in full or part without prior approval of Technical Communications Department, ABB Kent-Taylor.

Licensing, Trademarks and Copyrights

MODCELL™ and PC-30™ are trademarks of Asea Brown Boveri, Inc.

Modbus™ is a trademark of Modicon, Inc.

IBM™ and IBM PC AT™ are trademarks of International Business Machines Corp.

Health and Safety

To ensure that our products are safe and without risk to health, the following points must be noted:

1. The relevant sections of these instructions must be read carefully before proceeding.
2. Warning labels on containers and packages must be observed.
3. Installation, operation, maintenance and servicing must only be carried out by suitably trained personnel and in accordance with the information given.
4. Normal safety precautions must be taken to avoid the possibility of an accident occurring when operating in conditions of high pressure and/or temperature.
5. Chemicals must be stored away from heat, protected from temperature extremes and powders kept dry. Normal safe handling procedures must be used.
6. When disposing of chemicals ensure that no two chemicals are mixed.

Safety advice concerning the use of the equipment described in this manual or any relevant hazard data sheets (where applicable) may be obtained from the Company address on the back cover, together with servicing and spares information.

CONTENTS

These additional instructions are for Commander 200 Process Controllers which have been configured with either **Ramp/Soak Profile** option or the **Integration/Totalization** option. Controllers can be supplied configured with **either** option, but not both.

This manual is divided into two parts, one for each option, and must be read in conjunction with the Commander 200 Operating instructions, IM/C200.

CONTENTS • *Ramp/Soak*

Section	Page
1 INTRODUCTION	2
2 SETUP	4
2.1 General Preparations	4
2.2 Setup Method for Ramp/Soak	4
2.3 Database Reference Sections	4
2.3.1 Level 4 – High and Low Limit	4
3 OPERATION	8
3.1 Operation of Controller Using Ramp/Soak	8
3.1.1 Operation in Automatic	8
3.1.2 Controlling Ramp/Soak Profile	10
3.1.3 Reset	10
3.1.4 Skip	10
3.1.5 Event 1 or Event 2	10
3.1.6 Repeat	10
3.1.7 Ramp or Soak Hysteresis	11
3.2 Ramp/Soak Hold	11
3.3 Auto/Manual Transfer	11
3.1.1 Auto/Manual Transfer for On/Off Control	11
3.5 Operation in Manual	12
3.6 Ramp/Soak Digital Input Functions	12

CONTENTS • *Totalizer*

Section	Page
1 INTRODUCTION	13
2 SETUP	14
2.1 General Preparations	14
2.2 Setup Method for Totalizer	14
2.3 Database Reference Sections ..	14
2.3.1 Level 4 – High and Low Limit	14
2.4 Preset Value	17
2.5 Predetermined Count	17
3 OPERATION	18
3.1 Operation of Controller using Totalization	18
3.1.1 Examples of Totalizer Count Factors	20
3.1.2 Configured Flow Rate	20
3.1.3 Gallons/Count	20
3.1.4 Scale Factor	20
3.1.5 Rollover Time	21
3.2 Totalizer Digital Input Functions	21

1 INTRODUCTION • *Ramp/Soak*

The Ramp/Soak Profile option complements any type of control implementation by adding a ramp/soak profile with up to 15 segments of local set point ramp (up or down) or soak. Up to 5 separate programs may be configured from the 15 segments. Programs may overlap, i.e. use the same segments.





Fig. 1.1 shows a typical profile and some of its features. The profile is run in either hours or minutes. The maximum time for one ramp segment is 48 hours or 2880 minutes, the maximum time for one soak segment is 48 hours, 999.9 minutes or infinity. Ramp/Soak features include:

- repeating profile
- resetting profile
- skipping segments
- guaranteed ramps and soaks
- two segment event states (requires output relays B and C).

When both event states are enabled, high or low alarms are not available.

The process variable may be either a temperature or electrical input. The control algorithm receives the active set point from the ramp/soak profile (local set point) when the controller is operating in automatic. A calculated output signal is generated based on set point/process deviation and the configuration of the P, I, and D responses or the on/off responses. The calculated output goes to the output driver.

When ramp/soak is active, the remote set point cannot be made active and autotune cannot be entered. If the remote set point is active, ramp/soak cannot be made active in Level 1.

In addition to the auto mode with ramp/soak running, ramp/soak can be put into a hold mode using  and the set point can be changed via the front panel  / . Pressing  returns the unit to ramp/soak set point control at the point where it was held. When the control unit is switched from hold to manual by pressing , the ramp/soak profile pauses and the output value is changed via the control unit front panel switches. Output adjustment while in manual is from 0 to 100% of span. The shift from manual to auto is not bumpless. If the process value is at 70 in manual and the profile is at 80 (ramp or soak segment), the switch to auto causes the set point to increase to 80 and the control algorithm responds by calculating the output.

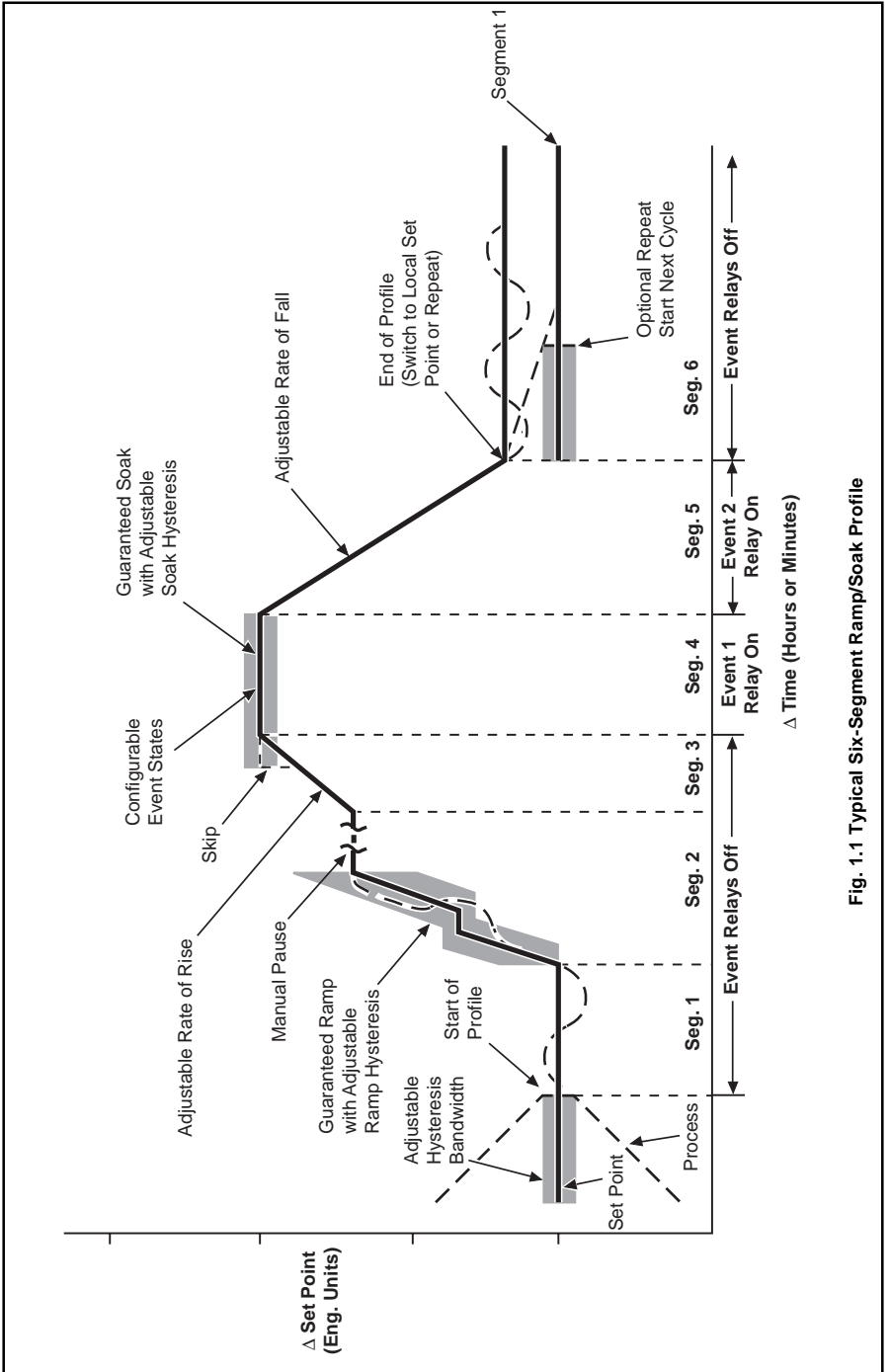

Fig. 1.1 Typical Six-Segment Ramp/Soak Profile

2 SETUP • Ramp/Soak

2.1 General Preparations

Make general setup entries using the database reference Sections 2.5.1 to 2.5.8 detailed in IM/C200.

2.2 Setup Method for Ramp/Soak

The setup parameters for ramp/soak are shown in the high-low limit accessed by Level 4, see – Fig. 2.1 of IM/C200.

2.3.1 Level 4 – High and Low Limit

2.3 Database Reference Sections

For controllers with ramp/soak, continue setup using the database reference Section 2.3.1 in this manual. During setup certain items do not appear, due to instrument configuration and selections made in the higher levels.

In this Section parameters in the lower display denoted ■ are Company Standard Settings. The controller is dispatched programmed with these settings.

LEU.4
HI.LO

Scroll to begin hi-lo limits setup. Use ▲ / ▼ change level.

Advance to **Dual Set Point 2 High**.

SP.2
r.SP.L
DUAL
NONE

Dual Set Point 2 High. Enter limit (*SP.2.L* to 9999), cannot be lower than dual set point 2 low limit.

r.R.P
SOAK.

Ramp/Soak Option. Point of entry. Use ▲ to access ramp/soak settings.

r.S.r.P
NONE ■
99
INFL

Ramp/Soak Repeat. Use ▲ / ▼ to access the type of cycle required:

NONE = No repeat cycle
1 to *99* = 1 to 99 repeat cycles
INFL = Infinite cycles.

S.HYS
999.9 ■

Soak Hysteresis. Use ▲ / ▼ to set the value of hysteresis band for guaranteed soaks from 0.1 to 999.9.

r.HYS
999.9 ■

Ramp Hysteresis. Use ▲ / ▼ to set the value of hysteresis band for guaranteed ramps from 0.1 to 999.9.

Continued on the next page...

...2.3.1 Level 4 – High and Low Limit

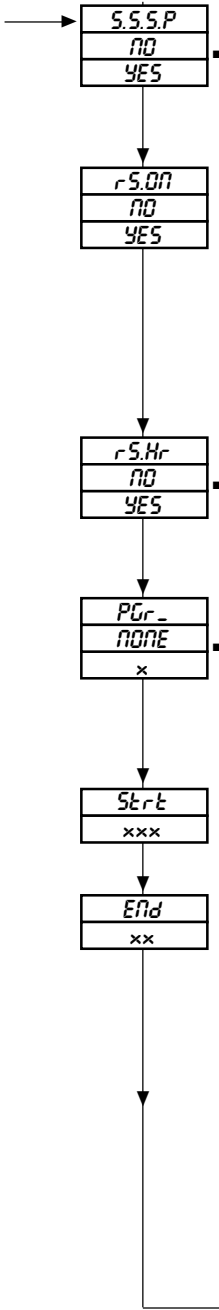

Self Seeking Set Point. Use / to select 'YES' or 'NO'.

When set to 'YES' the controller inserts the current process value as the starting set point on initiation of the profile.

Ramp/Soak Status.

'YES' indicates ramp/soak is on. If is pressed, the message 'r.S.ON', 'r.ONy' is displayed for a second to indicate ramp/soak is on and the profile can be read only. 'NO' indicates ramp/soak is off.

The ramp/soak status is controlled in Level 1 and must indicate 'NO' (off), to change the profile segment data in this Level, (this prevents the profile from being changed while it is active).

Ramp/Soak Unit of Time Hrs/Min. Use / to select 'YES' or 'NO'.

'YES' indicates the time in hours, 'NO' indicates the time in minutes. The time base applies to all segments.

Programme. Use / to access the programme to be configured:

- 'NONE' = Programme not selected
- '1' to '5' = Programme 1 to 5.

If 'NONE' selected takes operator to 'r.S.ON' ramp/soak enable.

Programme Start Segment. Use / to set the segment at which the programme will start from (1 to 15).

Programme End Segment. Use / to set the segment at which the programme is to end.

The end segment number must be higher than or equal to the start segment number.

Continued on the next page...

...2.3.1 Level 4 – High and Low Limit

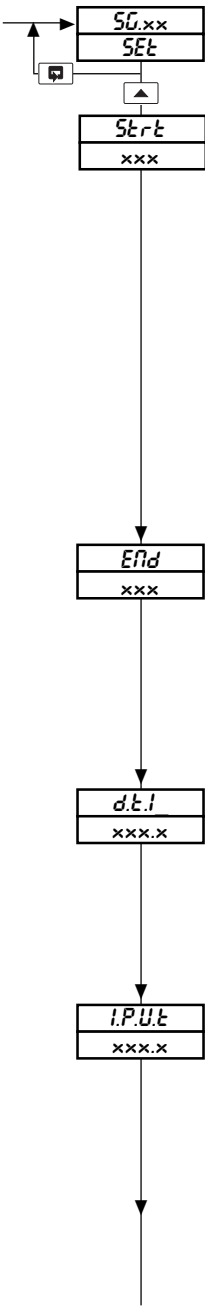

Segment Start Point. Use to access the segment start value, or use to access next segment number in programme.

Segment Start Value. Use / to set the segment starting value. The segment start value may only be set if it is first segment of a programme. Starting value is limited by the limits set in local set point high limit and local set point low limit.

A ramp has different start and end set point values. A soak has the same start and end set point values.

Before the first segment in a ramp/soak profile is started, the process must be within the hysteresis band for guaranteed ramps/soaks. If the difference between the process value and the active set point determined by segment 1 is greater than the configured ramp/soak hysteresis, the profile timer waits until the process value is within the hysteresis band before counting down. Since the hysteresis is tunable, the starting segment and guaranteed ramp or soak hysteresis value can be changed while the profile is active.

Segment End Value. Use / to set the segment end value.

End value is limited by the limits set in local set point high limit and local set point low limit.

If segment start/end values are the same (soak), advances the display to 'd.t.l.'. If segment start/end values are different (ramp), advances the display to 'I.P.U.t.'.

Soak Time. Use / to set soak time duration, units of time set in 'r.S.Hr':

0 to 999.9 if units of time in minutes

0.0 to 48.0 if units of time in hours

If 'INF' selected profile remains in segment until segment is skipped or program reset.

Ramp Rate. Use / to set ramp rate (set point value per unit of time).

The ramp rate is entered as the number of engineering units that change during the time period (hours or minutes) configured in 'r.S.Hr'.

continued...

Continued on the next page...

...2.3.1 Level 4 – High and Low Limit

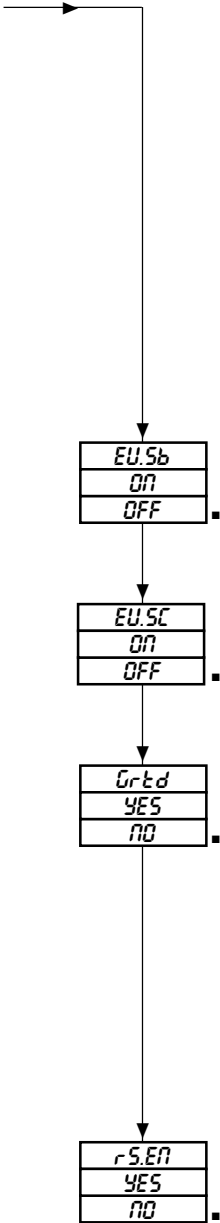

...continued from previous page

For example, if a ramp of 10°F at 2° every minute is required, the ramp rate value entered is 2.0 in the minutes time base. The Level 1 ramp/soak status display indicates minutes remaining and show a countdown from five minutes, when the active profile enters this segment.

The minimum ramp rate value is automatically limited so that the segment time cannot exceed 48 hours.

Ramp rates set excessively low over a wide range cannot be displayed properly at the minutes remaining display in Level 1. This display shows a maximum of 999.9 units of time. The display is decremented when the time remaining is less than 999.9.

Event State (Relay B). Use / to set event state 'ON' or 'OFF' for segment.

'ON' allows event relay B to be triggered whenever segment is active and the relay action is configured for ramp/soak in Level 3.

Event State (Relay C). Use / to set event state 'ON' or 'OFF' for segment.

'ON' allows event relay C to be triggered whenever segment is active and the relay action is configured for ramp/soak in Level 3.

Guaranteed Ramp or Soak. Use / to select 'YES' or 'NO'.

'YES' indicates guaranteed ramp or soak is on. 'NO' indicates guaranteed ramp or soak is off.

A guaranteed ramp or soak is a segment whose time is counted only if the process variable is within the hysteresis deadband set in 'S.HYS' or 'r.HYS' (in this Level).

If segment being configured is the last segment in the programme, returns the display to 'PGr_', otherwise returns the display to 'SG.xx' (start point next segment). When programme configured enter 'NONE' in programme to advance to 'r.S.En' (ramp/soak enable).



Ramp/Soak Enable. Use / to select 'YES' or 'NO'.

'YES' makes ramp/soak selectable in Level 1.

returns operator to Level 4 main loop.

3.1 Operation of Controller Using Ramp/Soak

3.1.1 Operation in Automatic

The controller starts at Level 1 in the same manner as detailed in IM/C200 Section 3. For the controller using ramp/soak, the operating displays and the sequence of their appearance are shown in Fig. 3.1. The operator can scroll to advance through the applicable display positions or use  /  for access code entry, ramp/soak status display access and level change. To access autotune or remote input capabilities, ramp/soak must be off.

If the Ramp/Soak display is enabled in Level 4, the ramp/soak display appears following a scroll from the process/output or alarm acknowledge display. The first display for ramp/soak is the program selected. The next display is the ramp/soak on/off status '*r S Off*'. If the status is '*YES*', the other status variables can be viewed. If the on/off status is '*NO*' the other status variables cannot be viewed.

The next status variable shown for ramp/soak is the current segment '*'*' to '*' 5*' the profile is running on. The segment number

can only be viewed in this level.

The next status variable is the time remaining in the current segment. This time is either minutes remaining '*..rE_*' or hours remaining '*H . rE_*'. If the time remaining exceeds 999.9, the display reads 999.9 until the time remaining falls below this value. The total minutes or hours remaining could be excessively large if the set point start and end points are far apart and the increment per unit time change rate is very small.

For example: a span of 101°F going through a change of 0.1°F every minute would take 1010.0 minutes to complete. This means the minutes remaining would stay at 999.9 for 10.1 minutes before counting down.

The last status variable shown for ramp/soak is the number of the current cycle in which the profile is running. This number starts at one, it increments each time the profile is repeated, and is reverts to one when the profile is reset. The cycle number stops counting once the number reaches 9999; however, the ramp/soak algorithm continues to run if the repeat is active.

The code display is shown next (providing a password has been enabled during setup). A correct code entry permits access to the ramp/soak reset and skip commands and tune or configure access to higher levels. An

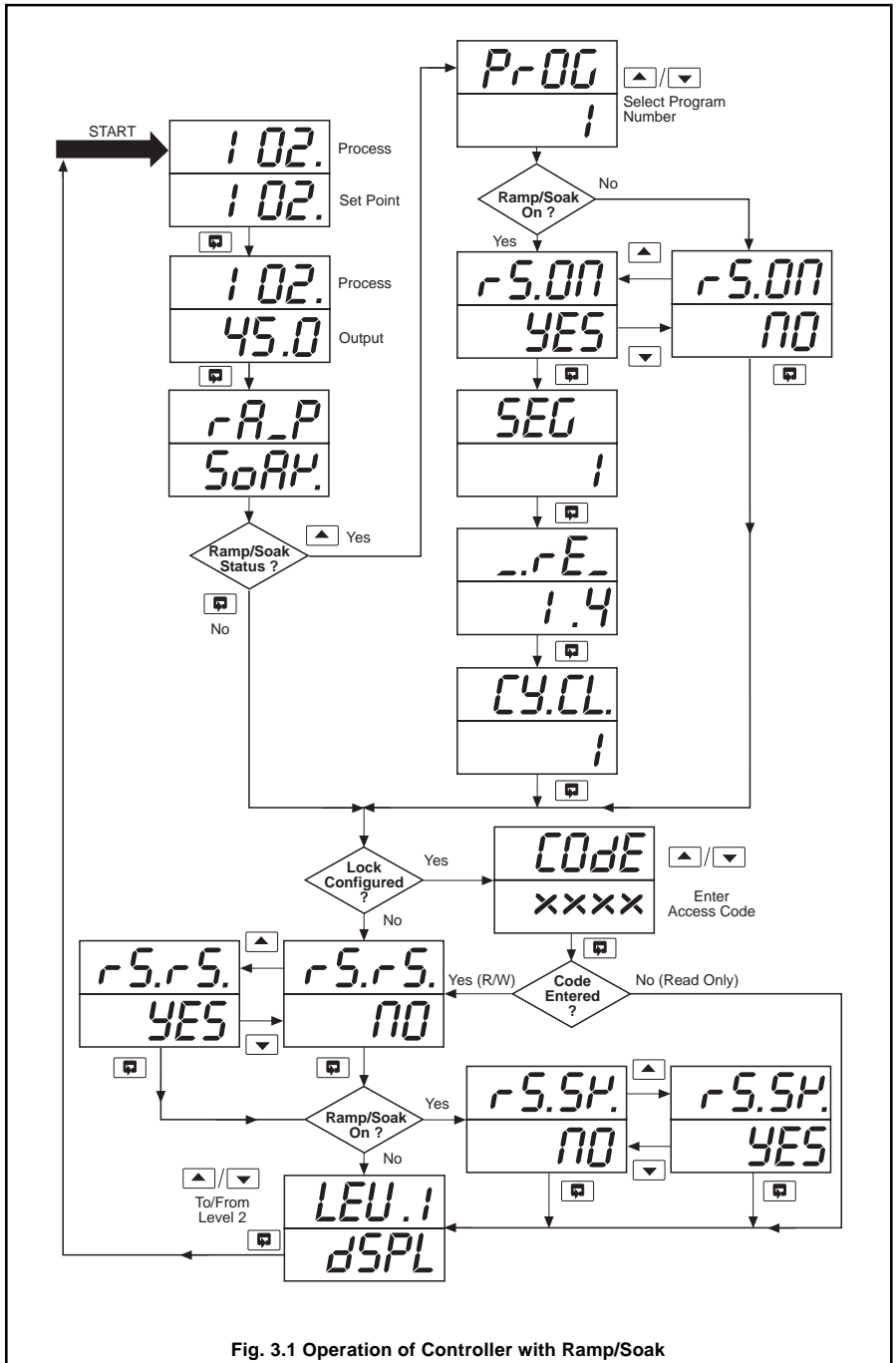

Fig. 3.1 Operation of Controller with Ramp/Soak

incorrect entry permits read only access to higher levels.

3.1.2 Controlling Ramp/Soak Profile



Control of the ramp/soak profile is implemented in Level 1 where the ramp/soak functions for reset and skip may be manipulated while ramp/soak is on '*r-5.0n*' '*NO*' '*YES*'.

Additional features are in Level 3 where event relays can be turned on or off and in Level 4 where ramp or soak hysteresis may be manipulated. Further access to the ramp/soak profile configuration in Level 4 can only be made if the ramp/soak status is turned off '*r-5.0n*' '*NO*' in Level 1. The configuration can be turned off (paused) in Level 1, viewed without changes and then continued from the current segment and cycle by being turned back on in Level 1. Sections 3.1.3 to 3.1.7 describe the manipulation of the ramp/soak profile.

3.1.3 Reset

The ramp/soak reset status '*r-5.r-5*' '*NO*' is a Level 1 ramp/soak command which is displayed when ramp/soak is enabled and either on or off. When '*YES*' is selected using , the ramp/soak profile is reset to segment one, cycle one (immediately if ramp/soak is on, or when turned on if it is off). Segment one begins its timer once the process variable is within the hysteresis set during configuration. The hysteresis can be changed as explained in Section 3.1.4. If no reset is required, leave the reset prompt at '*NO*' and scroll to the skip function.

3.1.4 Skip

The ramp/soak skip status '*r-5.Sr*' '*NO*' is a Level 1 ramp/soak command that only appears when ramp/soak is on. Selecting '*YES*' causes an immediate skip which cannot be cancelled by going back to '*NO*'. Also, multiple hits of  causes an equal number of skips. When '*YES*' is selected using the , the remaining portion of the

current ramp/soak profile segment is skipped and the profile responds in one of the following fashions.

- When the current segment is the last segment and repeat is on, the profile skips to segment one and continue as soon as the process is within the hysteresis.
- When the current segment is the last segment and repeat is not on, a skip causes the ramp/soak profile to turn off and the controller immediately reverts to local at the current set point.

When the current segment is any other segment, a skip causes the ramp/soak profile segment counter to be incremented by one. The profile then continues at the new set point for the next segment. Once again, the profile waits until the process and set point are within the hysteresis if the next segment is a guaranteed ramp or soak.

If no skip is required, leave the skip prompt at '*NO*' and scroll to the Level 1 display.

3.1.5 Event 1 or Event 2

Relay action is defined in Level 3 for events 1 and 2. When ramp/soak is on and event 1 is used, relay B can be used to indicate the event 1 state. Similarly, when event 2 is used, alarm relay C can be used to indicate the event 2 state.

3.1.6 Repeat

The ramp/soak repeat status '*r-5.rP*' is a Level 4 function in the ramp/soak configurator. '*NONE*' causes the profile to turn off and go into local at the ending set point after the last segment is completed.

When '*1 to 99*' is selected, the entire profile is repeated up to 99 times after the last segment is completed and the process and set point are within the hysteresis bandwidth for segment one.





When '*INFL*' is selected, the entire profile is

repeated after the last segment is completed and the process and set point are within the hysteresis bandwidth for segment one. The entire profile continues to repeat until the profile is reset.

3.1.7 Ramp or Soak Hysteresis





The ramp hysteresis status '*r.HYS*' and the soak hysteresis status '*s.HYS*' are also tunable functions in the ramp/soak configurator. A hysteresis value from 0 to 9999 is selected using  and defines a bandwidth around a guaranteed ramp or soak segment. The hysteresis bandwidth is used to count time in band (timer stops when value is outside hysteresis). The soak hysteresis value applies to the set point of all guaranteed soaks. The ramp hysteresis value defines a bandwidth around the set point of all guaranteed ramps. For segment one of a programme, the ramp or soak hysteresis bandwidth is used to determine when to start segment one.

3.2 Ramp/Soak Hold

The ramp/soak profile can be held while the controller is in auto by pressing . This causes the display to alternate between '*r 5*' '*HOLD*' and the process/set point display. In the hold mode, the set point can be changed using  /  (no other changes can be made). The controller controls to the new set point as long as it is in hold. Pressing  again puts the controller in manual with the ramp/soak functions still held. From either hold condition, pressing  returns the controller to the same place in the ramp/soak

profile where it left off (set point returns to the configured profile value). The instrument is switched into manual operation when the ramp/soak profile is on and the digital input is used for auto/manual transfer (no hold).

3.3 Auto/Manual Transfer

Transfers from automatic to manual or manual to automatic are made by pressing . When the control unit is operating on a ramp/soak set point,  must be pressed twice to switch to manual control. The first time  is pressed the unit is switched bumplessly to automatic with local set point. The second time  is pressed, the unit is switched to manual operation.

Transfers from automatic to manual are always bumpless and put the ramp/soak profile into a paused state. Transfers from manual to automatic result in a bump if the manual set point is not at the same value as the ramp/soak profile set point (the ramp/soak profile is paused at its current set point value when the controller is put in manual). The switch back to automatic causes the process variable to be under automatic control in response to the ramp/soak set point.



When ramp/soak is enabled, set point tracking is disabled. The set point and process may not be together at the time of transfer from manual to automatic. Again, the transfer causes a bump. The response following the transfer depends on the controller configuration. If the controller has integral response, the process ramps to the set point at the reset rate. If the controller does not have integral, the set point/process deviation at the time of transfer is maintained. This deviation can be eliminated by returning to manual, adjusting output to eliminate the deviation and switching back to automatic.

3.3.1 Auto/Manual Transfer for On/Off Control

If the controller is set up for on-off control, the bumpless transfer feature does not apply when switching from automatic to manual. When switched to manual, the on-off

controller output is always initialized at 0% when switched. Operation in manual is the same as for a time proportioning controller. When switching from manual back to automatic, operation is the same as for all other types of control as described in Section 3.4.6 of IM/C200.

3.4 Operation in Manual

When the controller is switched to manual, the first display seen is process/output. Output can be adjusted using  / . The scrolling sequence is the same as for the automatic mode as shown in Fig. 3.1.

3.5 Ramp/Soak Digital Input Functions

The digital input may be configured to provide two ramp/soak functions, The digital input is selected in Level 4 – see Section 2.5.4 of IM/C200.

The two ramp/soak functions are:

Run/Hold. When the switch is open the profile holds at the current location. When the switch is closed the profile is turned on if the profile is off or hold is released if the profile is on hold.

Run/Stop. When the switch is open the profile resets to the first segment of the programme and stop (this function is edge triggered).

The wiring guidelines for digital inputs are shown in Section 1, Figs. 1.3 and 1.4 of IM/C200.

1 INTRODUCTION • Totalizer

The integrator/totalizer provides the ability to integrate process flow rate signals and display totalized flow values on the front panel, as shown in Fig. 1.1. The integration/totalization function is available with a flow input only. The process flow signal can be in millivolts, volts, or milliamperes from a two-wire or non-two-wire transmitter. Signals which have a linear relationship with flow can be integrated and totalized directly. Flow signals, which are proportional to differential pressure require the application of square law linearization which is available as a standard function.

The integrator/totalizer algorithm converts process flow signals representing flow in terms of volume per unit time (i.e. gal/hr) into counts which are summed to provide a continuous read-out of total flow.

The integrator/totalizer can be configured to accept flow rate time bases in hours, minutes, or seconds. Alarm relays (B and C) can be used to signal the point at which the totalized value reaches the predetermined count.

The totalized value can be selected for read-out on the front panel displays using the front panel switches. When the totalizer display is selected, the total value is continuously displayed until another display is selected. The displayed total is a 7-digit number, leading zeros are not suppressed. To accommodate the seven characters required, the most significant digits are shown on the main display and the least significant digits are shown on the secondary display. For example: if the total value is 860,372 the

display reading is '086' '0372' – see Fig. 1.1.

Integrator/totalizer parameters are configured using the front panel switches in the same manner as for other parameters. Features which can be configured are as follows:

- **Preset Value** – (0 to 9,999,999). The value from which the totalizer starts its count.
- **Predetermined Count** – (0 to 9,999,999) The value at which the totalizer automatically resets when the wrap function is selected. Also, the relays can be configured to trip when the count reaches the predetermined count.
- **Wrap Function** – When selected, the wrap function causes the totalizer to automatically reset to the preset value and start over each time the predetermined count is reached.
- **Threshold Value** – The process input value below which the signal is not totalized.
- **Totalizer Type** – This feature permits the totalizer to be set up to count either up or down.

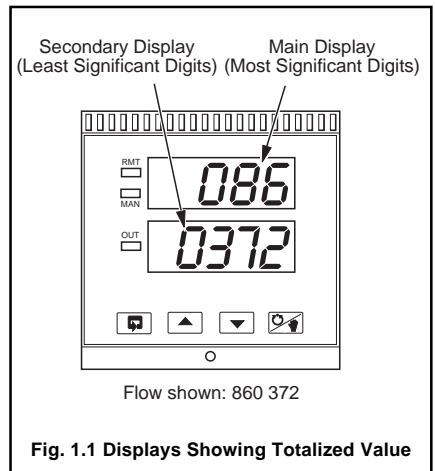

Fig. 1.1 Displays Showing Totalized Value

2 SETUP • Totalizer

- **Scale Factor** – This feature allows custom scaling of the totalized value. The reciprocal of the entered value (0.001 to 9999) is used as the totalizer scale factor.

2.1 General Preparations

Make general setup entries using the database reference Sections 2.5.1 to 2.5.8 detailed in IM/C200.

2.2 Setup Method for Totalizer

The setup parameters for the totalizer are

2.3.1 Level 4 – High and Low Limit

shown in the high-low limit accessed by Level 4, see – Fig. 2.1 of IM/C200.

2.3 Database Reference Sections

For controllers with totalization, continue setup using the database reference Section 2.3.1 in this manual. During setup certain items do not appear, due to the instrument configuration and selections made in the higher levels.

LEU4
HILO

Scroll to begin hi-lo limits setup. Use / to change Level.

Advance to **Dual Set Point 2 High**.

SP 2
rSPt
dURL
none

Dual Set Point 2 High. Enter limit (*SP.2.L* to 9999), cannot be lower than dual set point 2 low limit).

LOtL
CNFG

Totalizer Option. Point of entry. Use to access totalizer settings.

rRP
YES
NO

Wrap Feature. Use / to select 'YES' or 'NO'.

If 'YES' selected the totalizer counts until the predetermined count is reached, then reset to the preset value and start counting again.

If 'NO' selected the totalizer continues to count until it is turned off or the maximum count is reached. Maximum count is 9,999,999. When the maximum count is reached, the totalizer holds until there is operator intervention such as a reset in Level 1.

tHLd
0

Threshold Value. Use / to set threshold value in engineering units (limited by engineering units high value).

Process input signals below threshold are not totalized.

The threshold value permits filtering of the end of the process input signal range. The totalizer does not count signals below the threshold value. The decimal point location in the threshold value is the same as the decimal location in the process input engineering units.

Continued on the next page...

...2.3.1 Level 4 – High and Low Limit

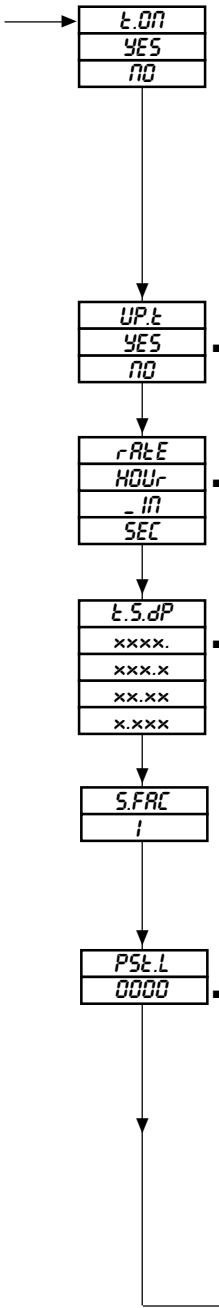

Totalizer Status.

'YES' indicates totalizer is on. If is pressed, the message 'E.ON', 'r.ONy' is displayed for a second to indicate totalizer is on.

'NO' indicates totalizer is off.

The totalizer status is controlled in Level 1 and must indicate 'NO' (off) to change the totalizer data in this Level. (This prevents the totalizer from being changed while it is active).

Select Totalizer Type. Use / to select totalizer type.

If 'YES' is selected totalizer counts up, if 'NO' is selected totalizer counts down.

Select Flow Rate Time Base. Use / to select rate in engineering units per 'HOUR' (hour), '_IN' (minute) or 'SEC' (second).

If the rate does not agree with the engineering units rate, a time factor is introduced.

Totalizer Scale Decimal Point. Use / to select location of decimal point for totalizer scale factor.

The location of the decimal point allows scale factors of 1 to 9999 (xxxx.), 0.1 to 999.9 (xxx.x), 0.01 to 99.99 (xx.xx) or 0.001 to 9.999 (x.xxx).

Totalizer Scale Factor. Use / to select factor where the decimal point is located (as set in totalizer scale decimal point).

For examples of how engineering units, rate and scale factor affect count and rollover time see Table 3.1.3.

Set Least Significant Digits of Preset Value. Use / to set the four least significant digits (_ _ _ xxx) in engineering units.

See Section 2.4 for reference information.

Continued on the next page...

...2 SETUP • Totalizer

...2.3.1 Level 4 – High and Low Limit

→

PdC.H
0000

 ■

Set Most Significant Digits of Preset Value. Use / to set the three most significant digits (0xxx_ _ _ _) in engineering units.

Complete preset value now has the form: xxxxxxxx.

See Section 2.4 for reference information.

↓

PdC.L
9999

 ■

Set Least Significant Digits of Predetermined Count. Use / to set the four least significant digits (_ _ _ _ xxxx) in engineering units.

See Section 2.5 for reference information.

↓

PdC.H
0999

 ■

Set Most Significant Digits of Predetermined Count. Use / to set the three most significant digits (0xxx_ _ _ _) in engineering units.

Complete predetermined count now has the form: xxxxxxxx.

See Section 2.5 for reference information.

↓

tE.n.
YES
NO

 ■

Totalizer Enable. Use / to select 'YES' or 'NO'.

'YES' makes totalizer selectable in Level 1.

returns operator to Level 4 main loop.

In this Section parameters in the lower display denoted ■ are Company Standard Settings. The controller is dispatched programmed with these settings.

2.4 Preset Value

The preset value is the number from which the totalizer starts counting. The value must be entered as a seven digit number. Leading zeros must be entered. For setup purposes the number shares the main and secondary displays. The three most significant digits are shown on the main display (preset high) and the four least significant digits are shown on the secondary display (preset low). The decimal point location in the preset value is the same as the decimal location in the process variable engineering units.

For example, the entries for positive values of 10,500, 3,450 and 1455.5 are as follows:

Preset High = '000'
Preset Low = '0500'
Equivalent Preset Value = 0010500
(10,500)

Preset High = '000'
Preset Low = '3450'
Equivalent Preset Value = 0003450
(3,450)

Preset High = '000'
Preset Low = '455.5'
Equivalent Preset Value = 001455.5
(1,455.5)

2.5 Predetermined Count

The predetermined count is the value at which the totalizer resets and starts over when the wrap function is enabled in 'rRP'. If a totalizer event relay is enabled in Level 3, the relay transfers to signal that the predetermined count has been reached.

The predetermined count has the same form as the preset value and its decimal point location is the same as the decimal location in the process variable engineering units. Setup entries for the predetermined count are made in the same manner as for the preset value, and all the same limitations apply. Refer to Section 2.4.



When the wrap function is enabled, entries for the predetermined count are restricted as follows:



- a) The predetermined count must not be equal to the preset value. The totalizer cannot be turned on if this condition exists.
- b) The predetermined count must be greater than the preset value if the totalizer is configured to count up, and less than the preset value if the totalizer counts down. For example, if the preset



value is 100 and the predetermined count is zero, the totalizer must count down. If it is configured to count up, it cannot be turned on.

3.1 Operation of Controller using Totalization

The operating procedure for a controller with integration/totalization is very similar to that of a non-totalizing controller. Application of power activates the front panel at Level 1. The first display is 'R.C' 'FAIL' indicating that instrument power has been off. Pressing any key increments the display to start the operating sequence.

The operating displays and the sequence of their appearance are shown in Fig. 3.1 for the controller using totalization (totalizer enabled in Level 4). The  / , and  symbols show where front panel switches are used to advance to the next display.

When a process input value is being displayed, the totalized value for that input can be viewed, if totalizer is on, by pressing  and  /  as shown in Fig. 3.1.

When a totalizer is off, the 'E.ON' 'NO' status appears and when  is pressed the totalizer status alternates between 'E.O.E' 'OFF' and the totalized value. The totalizer can be turned off or on while in Level 1 by using  /  to change 'E.ON' between 'NO' and 'YES'. The totalizer can be reset 'r.E.O.E' 'YES' in Level 1 to set the current totalized value to the preset value. 'NO' leaves current total unchanged. The preset value is the number from which the totalizer starts counting. It is commonly zero, but it can be set at any required value as described in

Section 2.4.

The threshold value and wrap selection can be changed whilst the totalizer is running by going into Level 4 and changing their configuration.

3.1.1 Examples of Totalizer Count Factors

There are three configurable factors that affect what one totalized count equals in actual flow and how quickly the totalizer counts. The first factor is the engineering units configured in Level 5. The other factors are the rate (engineering units time base) and the totalizer scale factor configured in Level 4.

Tables 3.1 and 3.2 together with Sections 3.1.2 to 3.1.5 give several examples of how these factors affect the totalizer count.

3.1.2 Configured Flow Rate

The configured engineering rate for totalization must be hours, minutes, or seconds. With a given actual maximum flow rate the equivalent flow rate can be calculated in hours, minutes or seconds, as required.

For example: Actual maximum flow rate = 6 million gallons per day.

This is equivalent to:

- a) 250000 gal/hr
- b) 4167 gal/min
- c) 69.45 gal/sec

The appropriate engineering units (set in

	Engineering Units	Display Multiplier	Configured Rate
a)	0 to 2500	100	Hour
b)	0 to 4167	1	Min
c)	0 to 69	1	Sec

Table 3.1 Calculation of Display Multiplier

Level 5) and the configured rate (set in Level 4) – see Table 3.1, can then be entered.

A display multiplier may be necessary as only four digits can be entered in the engineering units in Level 5. This display multiplier is used in the calculation of the scale factor – see Section 3.1.4.

3.1.3 Gallons/Count

The operator selects an appropriate number of gallons to equal 1 count. The gallons/count figure, in conjunction with the actual flow rate affects how quickly the totalizer counts. It also sets the required gallons/count resolution of the totalizer. For example 1 count could represent 1 or 100 gallons.

3.1.4 Scale Factor

The scale factor (set in Level 4, totalizer scale decimal = 100 gallons/totalizer scale factor) can be calculated as follows:

$$\text{Scale factor} = \frac{\text{count}}{\text{display multiplier}}$$

For example, if counting in 100's of gallons with a display multiplier of 100:

3.1.5 Rollover Time

The rollover time is based upon a maximum totalizer count of 9,999,999. When the decimal place is xxx.x, or 999,999.9 when the decimal place is xxx.x, etc.

The rollover time is an indication of how quickly the totalizer reaches its maximum count if the flow rate is running at its maximum. It can be calculated as follows:

$$\text{Rollover Time} = \frac{9999999 \times 1}{2500} = 4000 \text{ hours}$$

For example a), the engineering units are 2500gal/hr. If the counting units are 100's of gallons, the scale factor is 1 and the rollover time is:

3.2 Totalizer Digital Input Functions

The digital input may be configured to provide two totalizer functions, The digital input is selected in Level 4 – see Section 2.5.4 of IM/C200.

The two totalizer functions are:

Reset/Start. When the switch is closed the totalizer resets to the preset value and start counting (this function is edge triggered).

Start/Stop. When the switch is open the totalizer stops counting and hold the count. When the switch is closed the totalizer starts counting from a held count.

The wiring guidelines for digital inputs are illustrated in Section 1, Figs. 1.3 and 1.4 of IM/C200.

Actual Flow at 100%	Configured Engineering Units (see *1)	Scale (Display Multiplier)	Configured Rate (see *1)	Scale Factor (see *3)	1 Count Equals (see *2)	Minimum Rollover Time (see *4)
6,000,000 gal/day	0 to 4167 gal/min	x1	Min	1	1 gallon	40.0 Hours
6,000,000 gal/day	0 to 416.7 gal/min	x10	Min	0.1	1 gallon	4.0 Hours
6,000,000 gal/day	0 to 416 gal/min	x10	Min	1	10 gallons	400 Hours
6,000,000 gal/day	0 to 2500 gal/hr	x100	Hours	1	100 gallons	167 Days
6,000,000 gal/day	0 to 2500 gal/hr	x100	Hours	0.01	1 gallon	40.0 Hours
600 gal/sec	0 to 600 gal/sec	x1	Sec	6	6 gallons	27.8 Hours
600 gal/sec	0 to 100 gal/sec	x6	Sec	1	6 gallons	27.8 Hours
600 gal/sec	0 to 3600 gal/min	x10	Min	1	10 gallons	46.3 Hours
600 gal/sec	0 to 360.0 gal/min	x100	Min	0.1	10 gallons	4.63 Hours
600 gal/sec	0 to 6 gal/sec	x100	Sec	1	100 gallons	463 Hours
600 gal/sec	0 to 360 gal/min	x100	Min	1	100 gallons	463 Hours
600 gal/sec	0 to 600 gal/sec	x1	Sec	600	600 gallons	115.7 Days
600 gal/sec	0 to 1 gal/sec	x600	Sec	1	600 gallons	115.7 Days
60 gal/min	0 to 60 gal/min	x1	Min	1	1 gallon	115.7 Days
60 gal/min	0 to 60.00 gal/min	x1	Min	1	1 gallon	27.78 Hours

Table 3.2 Examples of Totalizer Count Factors

*1 Refer to Section 3.1.2

*2 Refer to Section 3.1.3

*3 Refer to Section 3.1.4

*4 Refer to Section 3.1.5

NOTES

PRODUCTS & CUSTOMER SUPPORT

A Comprehensive Product Range

Analytical Instrumentation

- **Transmitters**
On-line pH, conductivity, and dissolved oxygen transmitters and associated sensing systems.
- **Sensors**
pH, redox, selective ion, conductivity and dissolved oxygen.
- **Laboratory Instrumentation**
pH and dissolved oxygen meters and associated sensors.
- **Water Analyzers**
For water quality monitoring in environmental, power generation and general industrial applications including: pH, conductivity, ammonia, nitrate, phosphate, silica, sodium, chloride, fluoride, dissolved oxygen and hydrazine.
- **Gas Analyzers**
Zirconia, paramagnetic, infrared, thermal conductivity.

Controllers & Recorders

- **Controllers**
Digital display, electronic, pneumatic. Discrete single-loop and multi-loop controllers which can be linked to a common display station, process computer or personal computer.
- **Recorders**
Circular and strip-chart types (single and multi-point) for temperature, pressure, flow and many other process measurements.

Electronic Transmitters

- **Smart & Analog Transmitters**
For draft, differential, gauge and absolute pressure measurement. Also, liquid level and temperature
- **I to P Converters and Field Indicators**

Flow Metering

- **Magnetic Flowmeters**
Electromagnetic, insertion type probes and watermeters.
- **Turbine Flowmeters**
- **Wedge Flow Elements**
- **Mass Flow Meters**
Transmitters, sensors, controllers and batch/display units.

Level Control

- **Submersible, Capacitance & Conductivity.**

Pneumatic Instrumentation

- **Transmitters**
- **Indicating Controllers**
- **Recording Controllers**

Customer Support

ABB Kent-Taylor provides a comprehensive after sales service via a Worldwide Service Organization. Contact one of the following offices for details on your nearest Service and Repair Centre.

United Kingdom

ABB Kent-Taylor Limited
Tel: +44 (0)1480 470781
Fax: +44 (0)1480 470787

United States of America

ABB Kent-Taylor Inc.
Tel: +1 716 2926050
Fax: +1 716 2736207

Italy

ABB Kent-Taylor SpA
Tel: +39 (0) 344 58111
Fax: +39 (0) 344 56278

Client Warranty

Prior to installation, the equipment referred to in this manual must be stored in a clean, dry environment, in accordance with the Company's published specification. Periodic checks must be made on the equipment's condition.

In the event of a failure under warranty, the following documentation must be provided as substantiation:

1. A listing evidencing process operation and alarm logs at time of failure.
2. Copies of operating and maintenance records relating to the alleged faulty unit.



ABB Kent-Taylor Ltd.
St. Neots,
Cams.
England, PE19 3EU
Tel: (01480) 475321
Fax: (01480) 217948

ABB Kent-Taylor Inc.
PO Box 20550, Rochester
New York 14602-0550
USA
Tel: (716) 292 6050
Fax: (716) 273 6207

ABB Kent-Taylor SpA
22016 Lenno
Como
Italy
Tel: (0344) 58111
Fax: (0344) 56278

The Company's policy is one of continuous product improvement and the right is reserved to modify the information contained herein without notice.

© April 1996 ABB Kent-Taylor Printed in U.K.