

Operating Instructions

COMMANDER C200 Process Controller



ABB INSTRUMENTATION

The Company

ABB Instrumentation is an established world force in the design and manufacture of instrumentation for industrial process control, flow measurement, gas and liquid analysis and environmental applications.

As a part of ABB, a world leader in process automation technology, we offer customers application expertise, service and support worldwide.

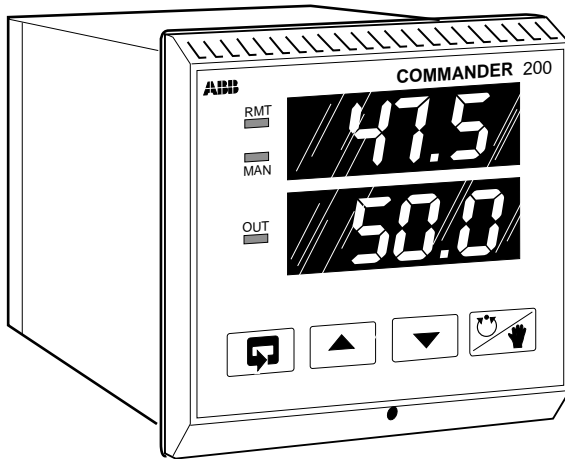
We are committed to teamwork, high quality manufacturing, advanced technology and unrivalled service and support.

The quality, accuracy and performance of the Company's products result from over 100 years experience, combined with a continuous program of innovative design and development to incorporate the latest technology.

The NAMAS Calibration Laboratory No. 0255 is just one of the ten flow calibration plants operated by the Company, and is indicative of ABB Instrumentation's dedication to quality and accuracy.

BS EN ISO 9001



St Neots, U.K. – Cert. No. Q5907

Stonehouse, U.K. – Cert. No. FM 21106

EN 29001 (ISO 9001)



Lenno, Italy – Cert. No. 9/90A



Stonehouse, U.K.

Use of Instructions



Warning.

An instruction that draws attention to the risk of injury or death.



Caution.

An instruction that draws attention to the risk of damage to the product, process or surroundings.



Note.

Clarification of an instruction or additional information.



Information.

Further reference for more detailed information or technical details.

Although **Warning** hazards are related to personal injury, and **Caution** hazards are associated with equipment or property damage, it must be understood that operation of damaged equipment could, under certain operational conditions, result in degraded process system performance leading to personal injury or death. Therefore, comply fully with all **Warning** and **Caution** notices.

Information in this manual is intended only to assist our customers in the efficient operation of our equipment. Use of this manual for any other purpose is specifically prohibited and its contents are not to be reproduced in full or part without prior approval of Technical Communications Department, ABB Instrumentation.

Health and Safety

To ensure that our products are safe and without risk to health, the following points must be noted:

1. The relevant sections of these instructions must be read carefully before proceeding.
2. Warning labels on containers and packages must be observed.
3. Installation, operation, maintenance and servicing must only be carried out by suitably trained personnel and in accordance with the information given.
4. Normal safety precautions must be taken to avoid the possibility of an accident occurring when operating in conditions of high pressure and/or temperature.
5. Chemicals must be stored away from heat, protected from temperature extremes and powders kept dry. Normal safe handling procedures must be used.
6. When disposing of chemicals ensure that no two chemicals are mixed.

Safety advice concerning the use of the equipment described in this manual or any relevant hazard data sheets (where applicable) may be obtained from the Company address on the back cover, together with servicing and spares information.

CONTENTS

Contents	Page	Contents	Page
1 INSTALLATION	2	3.5 Operation in Manual	29
1.1 Unpacking	2	3.6 Remote/Local or Dual/Local Set Point Transfer	29
1.2 Mounting	2	3.7 Control Output Limiting	30
1.3 Shipped Configuration	3	3.8 Alarms	30
1.4 Cleaning the Displays	3	3.8.1 Alarm Messages	30
1.5 Wiring Guidelines	4	3.8.2 Alarms with Acknowledgement	30
1.6 I/O Specifications	8	3.8.3 Acknowledgement Procedure	30
2 SETUP	9	3.9 Manual Tuning	31
2.1 General Preparations	9	3.10 Automatic Tuning	32
2.2 Setup Levels	9	3.10.1 Setup Process	32
2.3 Setup Method	9	3.10.2 Autotune Setup Procedure	33
2.4 Setup Controls	9	3.10.3 Completion	35
2.5 Database Reference Sections	9	3.10.4 Manual Cancellation During Setup	35
2.5.1 Level 9 – Control and Input Type	11	3.10.5 Manual Cancellation During Execution	35
2.5.2 Level 6 – Enable	11	3.10.6 Autotune Restart	35
2.5.3 Level 5 – Input	13	3.10.7 Automatic Cancellation and Diagnostics	35
2.5.4 Level 4 – High and Low Limit	16	3.10.8 Autotune Diagnostic Displays and Definition	36
2.5.5 Level 3 – Alarm	18	3.10.9 Autotune Restart Instructions	36
2.5.6 Level 2 – Tune	20		
2.5.7 Level 7 – Diagnostics and Temperature Calibration	22		
2.5.8 Level 8 – RS485 Interface	23		
3 OPERATION	24	4 DIAGNOSTICS	37
3.1 Control Keys	24	4.1 Input Failure and Power Failure Detection	37
3.2 Startup	24	4.2 Diagnostic Messages	37
3.3 Operation in Automatic	24	4.3 Input Failure Messages and Responses	38
3.4 Auto/Manual Transfer	28	4.4 Operational Failure Messages	38
3.4.1 ...with Local Set Point	28		
3.4.2 ...with Remote Set Point	28		
3.4.3 ...with Dual Set Point	28		
3.4.4 ...with Local Set Point	28		
3.4.5 ...without Local Set Point Tracking	28		
3.4.6 ...for On/Off Control	28		
		5 DATABASE RECORD	39

1 INSTALLATION



Caution. Prior to shipment, the controller has been configured to operate on either 117V or 234V a.c. power and to accept a thermocouple process input. Refer to Section 1.3 opposite before applying power.

1.1 Unpacking

Unpack and visually inspect the controller. A bag containing a cold junction compensating thermistor and a selection of engineering unit labels is included to identify the process variable display units. Attach appropriate label next to the upper display. Save packing materials for any re-shipment, or to support any claim of shipment damage. All damage claims are made against the carrier and are the responsibility of the customer.

1.2 Mounting Fig. 1.1

Select a mounting location where there is minimum vibration. The ambient temperature must be between 32 and 131° F (0 and 55° C). Fig. 1.1 shows installation views. The panel must provide rigid support for the 2.5lb (1.134kg) controller and any other panel devices. Adjacent controllers may be mounted as close as possible horizontally and 1 inch (25.4mm) vertically if support is adequate. Ensure that electrical wiring routing and support are planned. To install mounting brackets, loosen jack screw and remove instrument from housing. After mounting housing, insert instrument and tighten jack screw two turns after front face draws into gasket.



Caution. If the controller is to be sited in an area where NEMA - 4x/IP 66 is required, fit the Jack Screw Bung supplied in the accessory kit into the jack screw recess – see Fig. 1.1.

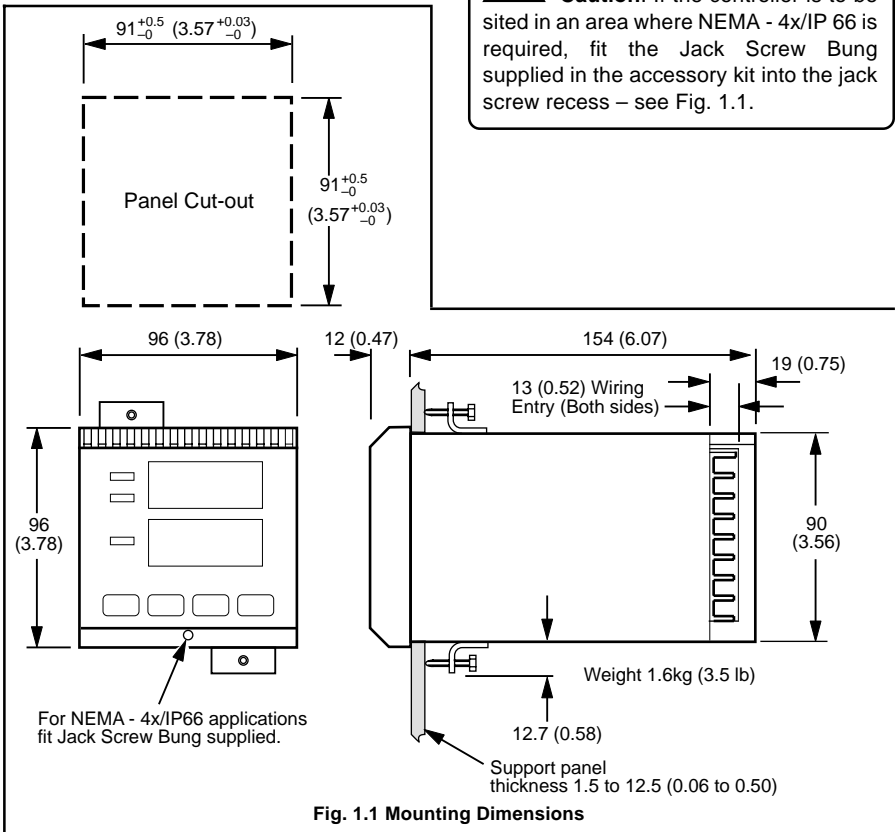

1.3 Shipped Configuration – Fig. 1.2

A configuration label on the side of the instrument identifies the as-shipped configuration of the controller. The jumpers associated with primary power, process input, and RS485 communication (if used) may be correct in their as-shipped position. If changes in the jumper positions are required, remove the instrument from its housing, and change the jumper positions from the rear as shown in Fig. 1.2.

***** **Note.** This position must be used if the instrument is to be configured for thermocouple input and is replacing a 200R controller (or pre 2100 Series, Issue 3 Software COMMANDER 200 controller) fitted with a thermistor.

1.4 Cleaning the Displays

The face of the displays, while made of scratch-resistant plastic, can be abraded by harsh materials such as paper towels and industrial wipes. Lens cleaning tissues and soft cloths are suitable for cleaning displays.

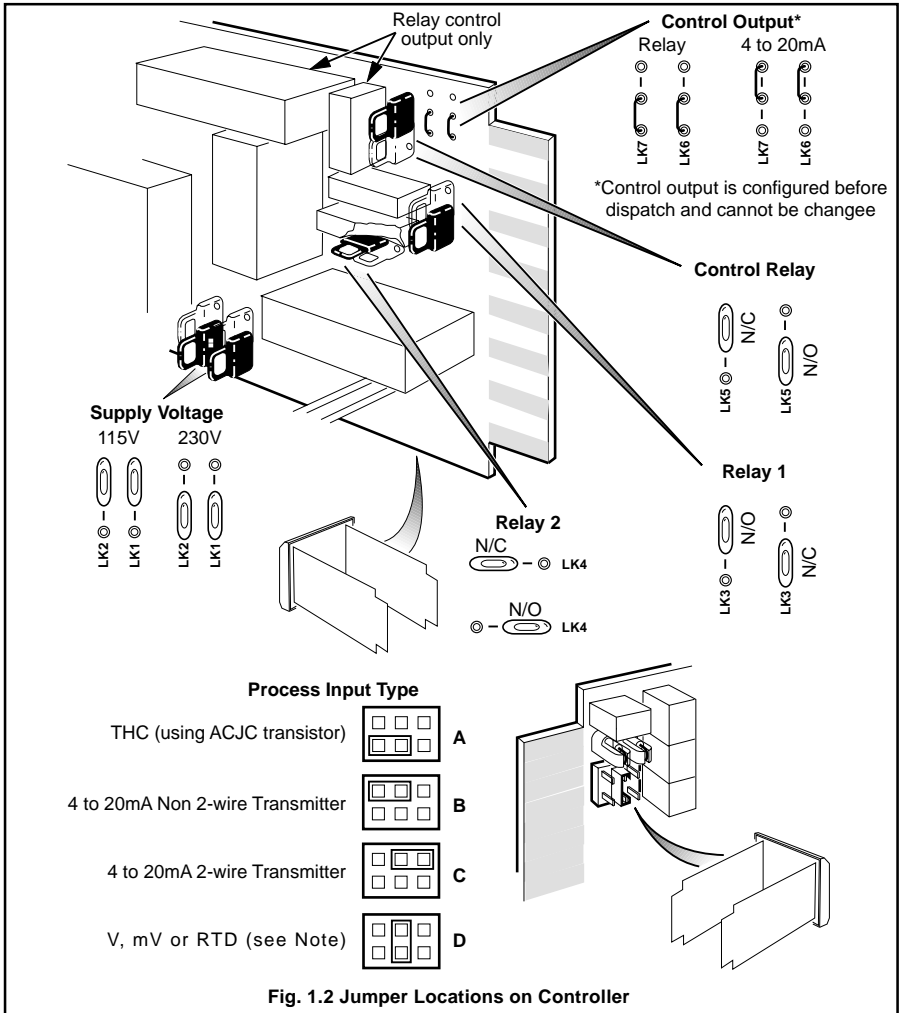

Fig. 1.2 Jumper Locations on Controller

...1 INSTALLATION

1.5 Wiring Guidelines

– Figs. 1.3 to 1.6

The power wiring connections and input/output (I/O) connections are made with the controller installed in its operating location and with the power off. The rear view of the controller housing in Fig. 1.3 shows the terminals available for inputs and outputs. The recommended wiring procedure is as follows:

a) Route low-level signal wiring from the left and a.c. voltage wiring from the right and distribute to appropriate terminals. Terminal blocks accommodate wire sizes from 14AWG (1.6mm) to 24AWG (0.5mm).

- b) Use a small, Phillips-head screwdriver to loosen appropriate connection screws and clamps on terminal blocks.
- c) Strip approximately 5/16 inch (8mm) of insulation from end of each wire, insert wires at assigned terminals and secure terminal screws and clamps.
- d) Connect green ground wire to panel ground, as shown in Fig. 1.3, to dampen out noise spikes on the a.c. line.
- e) After all connections are completed and checked, proceed to Section 2.

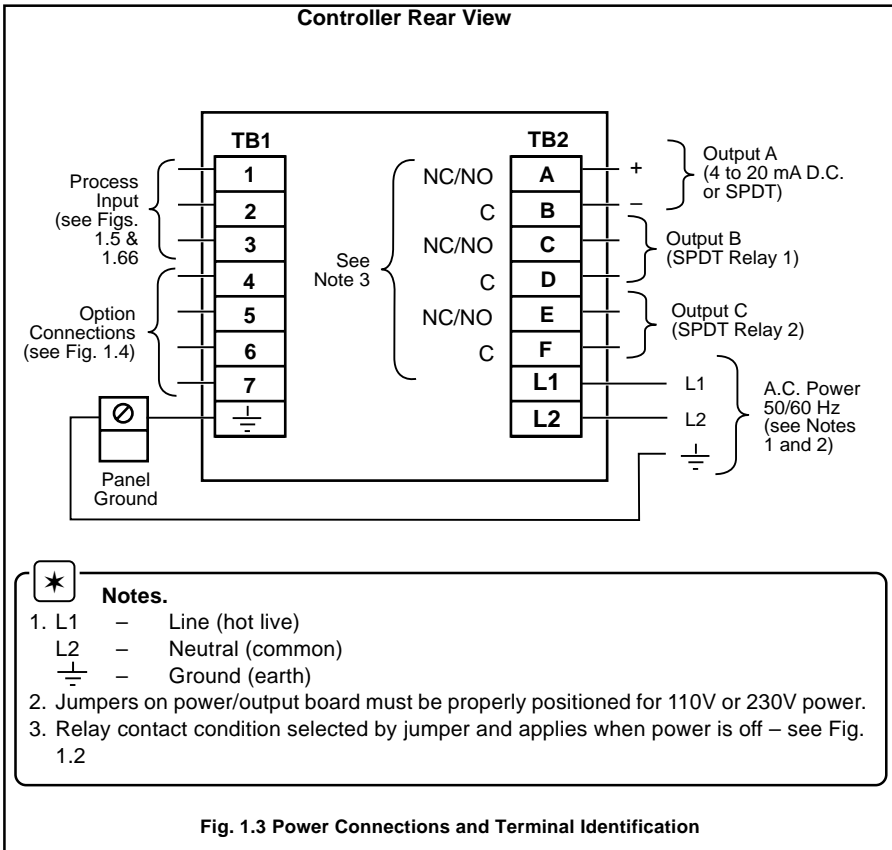
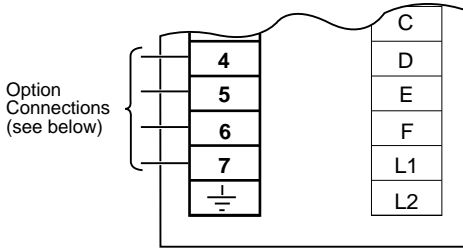
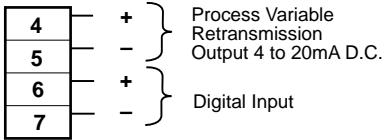

Fig. 1.3 Power Connections and Terminal Identification



A – Option Connections Terminals



B – Retransmission and Digital Input Connections

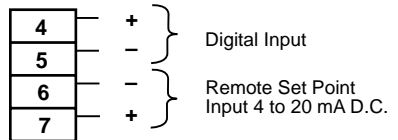

C – Remote Set Point and Digital Input Connections

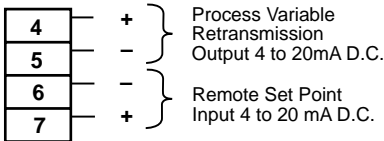

D – Retransmission and Remote Set Point Connections

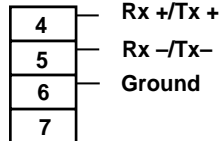

E – RS485 Connections

Fig. 1.4 Option Connections

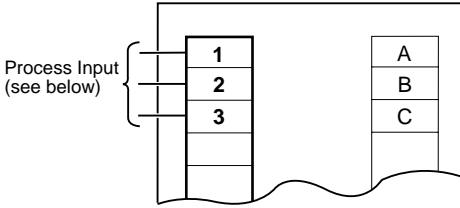

A – Process Input Connections Terminals

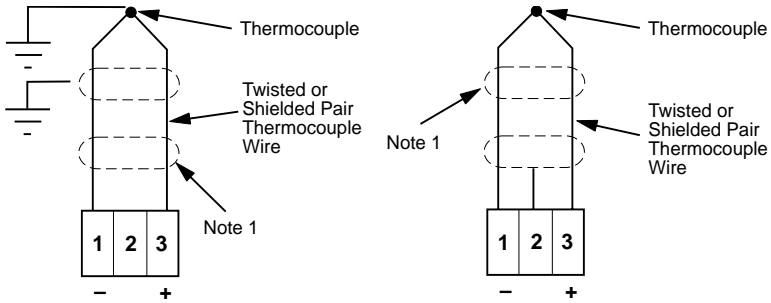

B – Thermocouple Input Connections (see also Notes 2 and 3)

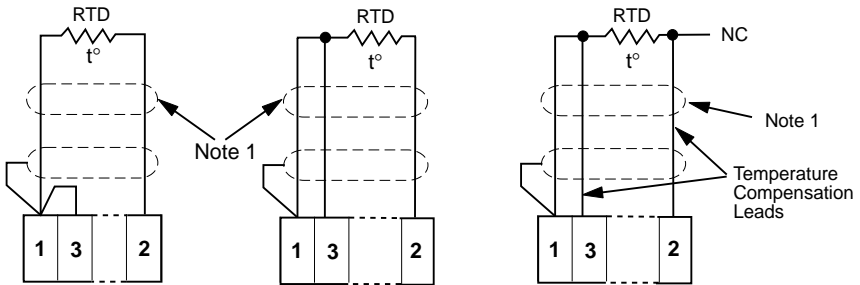

C – Resistance Thermometer Input Connections

Notes.

1. Shield to be left unconnected at this end.
2. Ensure that the input type jumper is positioned as shown in Fig. 1.2, diagram A.
3. If a thermistor is connected across terminals 1 and 2, ensure the input type jumper is positioned as shown in Fig. 1.2, diagram D.

Fig. 1.5 Process Input Connections (THC and RTD)

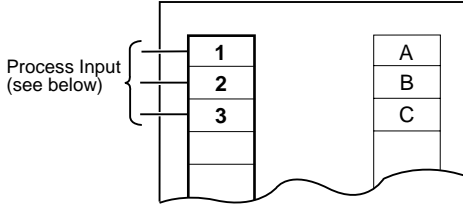

A - Process Input Connections Terminals

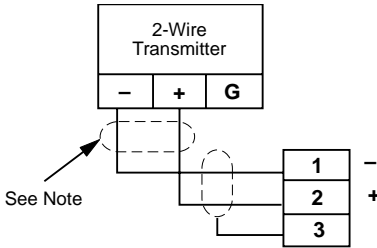

Note. Shield to be left unconnected at this end

B - 2-wire Milliampere Input (4 to 20mA D.C.)

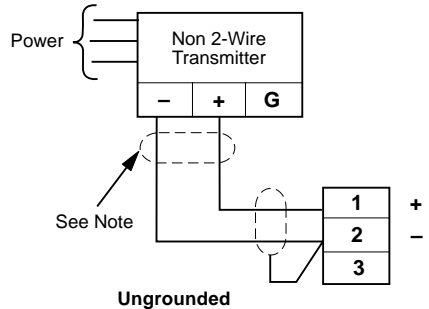
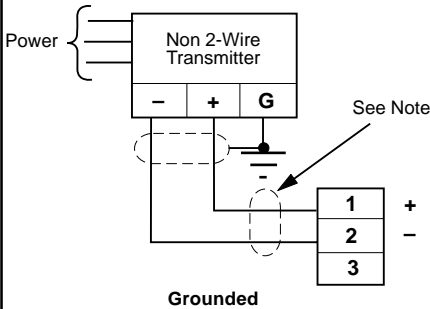

Grounded

Ungrounded

C - Non 2-wire Milliampere Input (4 to 20mA D.C.)

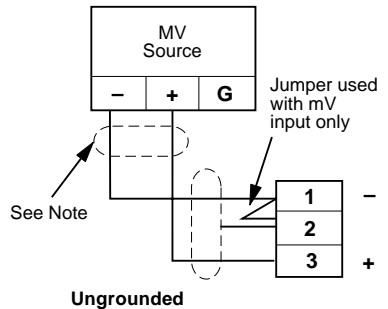
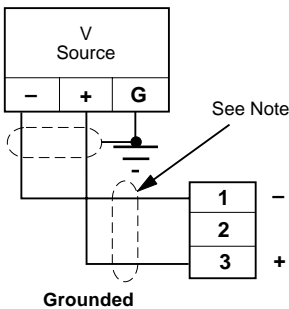

Grounded

Ungrounded

D - Volt and Millivolt

Fig. 1.6 Process Input Connections (V, mV and mA)

...1 INSTALLATION

1.6 I/O Specifications

POWER REQUIREMENTS

Power Supply: 115/230V a.c. $\pm 15\%$, 50/60Hz

Power Consumption: 4VA nominal,
10VA maximum

PROCESS INPUTS

Thermocouple: Automatic ranging and linearization

Type B*: 752 to 3272°F (400 to 1800°C)

Type E: -148 to 1652°F (-100 to 900°C)

Type J: -148 to 1652°F (-100 to 900°C)

Type K: -148 to 2372°F (-100 to 1300°C)

Type N: -328 to 2372°F (-200 to 1300°C)

Type R* & S*: 0 to 3092°F (-18 to 1700°C)

Type T: -418 to 572°F (-250 to 300°C)

* Performance accuracy is not guaranteed below 400°C (752°F).

RTD: Automatic ranging and linearization

3-Wire Platinum, 100 Ω per DIN standard 43760, with range of 0 to 400 Ω : -328 to 1112°F (-200 to 600°C)

Volts: 0 to 5V d.c., Span, 0.1 to 5V d.c.

Millivolts: 0 to 150mV d.c., Span, 10 to 150mV d.c.

Current: 4 to 20mA d.c.; Span, 1 to 16mA d.c.

Current and Voltage: Square law linearization is configurable for differential pressure inputs

Thermocouple cold

junction compensation: An automatic cold junction (ACJC) transistor built-in for use with thermocouple inputs.

Transmitter Power Supply:

24V d.c. transmitter power supply selectable for 20mA d.c. current input from 2-wire transmitter

Remote Set Point Input (Optional):

4 to 20mA d.c., 100 Ω input impedance.

Digital Input (Optional): Contact Closure, or D.C. Voltage

Open Resistance: 50K Ω minimum, or 4 to 24V d.c.

Closed Resistance: 50 Ω maximum, or <1.5V d.c.

Sample Rate:

V, mV, mA – 4 per second

RTD, Thermocouple – 4 per second

Digital Input – 4 per second

OUTPUTS

Control

Current: 4 to 20mA d.c. (0 to 100%) into 750 Ω maximum load with overrange of 2.72 to 21.6mA d.c. (-8 to 110%), reversible

SPDT Relay: rated for 5A at 120/240V a.c.

Alarm

One or Two SPDT Relays rated for 5A at 120/240V a.c.

Retransmission (Optional)

4 to 20mA d.c. into 750 Ω maximum load





2 SETUP



Caution. Be sure the process can be maintained in safe conditions before turning on controller power. The controller may not be properly configured to meet the specific requirements of the process until setup has been performed.

2.1 General Preparations

Begin setup by preparing the controller as follows:

- a) At a.c. power source, connect power to controller. When power is turned on, the front panel character displays are illuminated. *R.C. FAIL* is displayed showing that power has been off.
- b) Ensure the MAN indicator is illuminated, showing that the controller is in the manual mode. If necessary, press and release  key to enter manual mode (refer to page 24). If the controller remains in the Auto mode the parameters in Levels 5 to 9 can be viewed but not altered.
- c) Scroll to the next display (press and release ). Other power-up diagnostic messages may appear as described in Section 4. Scroll again to obtain process input value on the main (upper) display and percent controller output on the secondary (lower) display. The OUT indicator is illuminated when output is displayed. The Access Code and other parameter messages may appear as described in Section 3.
- d) Press the  or  key to adjust output to a safe value for setup if necessary.

2.2 Setup Levels – Fig. 2.1





For ease of use, the firmware has been divided into nine functional levels. The first level is for daily continuing operation, and the remaining eight levels are for setup and tuning. The setup levels, the method of moving from one level to another, and the operational loop associated with each level are shown in Fig. 2.1. Data entries are made by scrolling through the steps in each level of the setup procedure, and making an appropriate response to each step.

2.3 Setup Method



Initial setup begins with Level 9 and then 6 through 2. This order resolves basic factors first, those which affect settings at other levels and which are not likely to change; Level 9 for selecting input and control type; Level 6 for enabling lock, setting direct/reverse action, etc.; Level 5 for defining input and positioning decimal point; and Level 4 for setting operating limits. Positioning decimal point in level 5 also affects Level 6 remote set point values. Levels 3 and 2, Alarms and Tuning, are more closely related to specific process details and are more subject to later alteration.

Setup concludes with Levels 7 and 8. Level 7, Temperature Calibration is required when the process input is a thermocouple or RTD. Level 8 for RS485 communications is required only when the instrument is equipped with the RS485 communications option.

2.4 Setup Controls

Use the  key to move through the basic setup steps within a level. Use the  key for points of entry within a level. Use the  and  keys to ascend/descend through setup levels, or *YES/no* responses.



Note. Continued pressure on the  and  keys causes the rate of change of the displayed value to increase. To make small adjustments, operate the keys momentarily.

2.5 Database Reference Sections

The database reference Sections (2.5.1 to 2.5.8) are put in the order needed for initial setup. All data base items are listed for this instrument. As you go through the data base, certain items do not appear. This is because of the instrument configuration and selections made in the higher levels.

In this Section parameters in the lower display denoted  are Company Standard Settings. The controller is dispatched programmed with these settings.

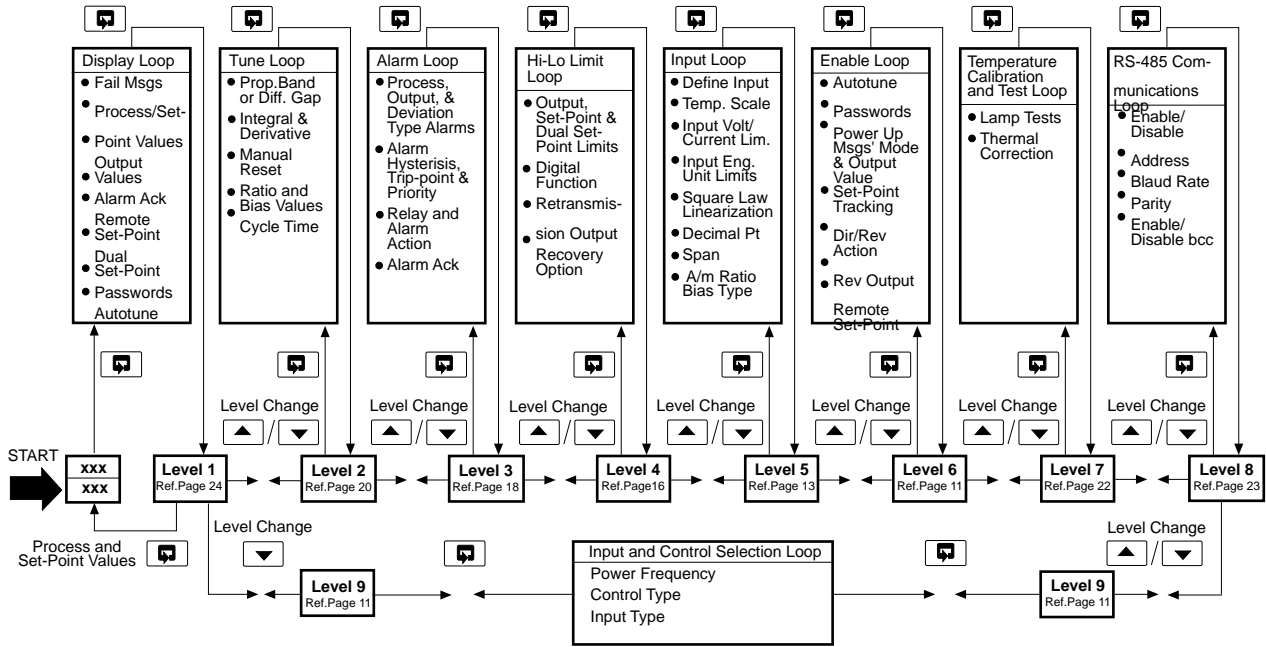
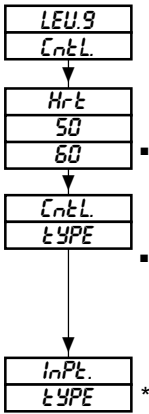

Fig. 2.1 Relationship of Setup Levels and Loops

2.5.1 Level 9 – Control and Input Type



Scroll to begin control and input type setup (/ changes level).

Hertz. Use / to select a.c. source frequency value.

Control Type. Use / to select type. Control choices are restricted based on hardware configuration. The types are:

- on.off.* = On/Off
- TP* = Time Proportioning
- CP* = Current Proportioning

Input Type. Use / to select type. Input jumper must match type selected. The types are:

- UoLt.* = 0 to 5V d.c. input
- _ULt* = 0 to 150mV d.c. input
- tCPL* = Thermocouple input
- r.t.d.* = RTD input
- _R_P* = 4 to 20mA d.c. input

* *TYPE* flashes before displaying current choice.

2.5.2 Level 6 – Enable

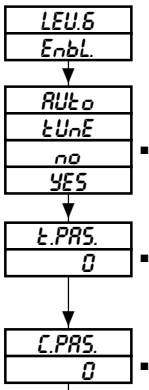

Scroll to begin enable setup (/ changes level).

Automatic Tuning Enable. = *YES*. = *no*. '*YES*' makes automatic tuning selectable in Level 1. '*no*' disables feature. See Section 3 for automatic tuning procedure.

Tune Password. Enter value (0 to 9999). Entering the proper tune password in Level 1 allows read access to all levels and tune access to Levels 2 through 4.

Configure Password. Enter value (0 to 9999). Entering the proper configure password in Level 1 allows complete access to all levels.

Continued on the next page

...2 SETUP

...2.5.2 Level 6 – Enable

<i>P.UP_</i>
<i>no</i>
<i>YES</i>

...**Power-up Message.** = *YES*. = *no*. '*YES*' displays *A.C. FRIL* upon power-up. '*no*' suppresses message after 2 seconds.

<i>P._dE</i>
<i>LAST</i>
<i>_Rn</i>
<i>Auto</i>

Power-up Mode. Use / to move through choices. *LAST* causes controller to power-up in the same mode it was in when it lost power. Manual and auto cause the controller to power-up in the mode selected.

<i>o.UAL</i>
<i>0.0</i>

Fixed Power-up Output Value. Enter value (limited by the output high and low limits in Level 4).

<i>SP.tk</i>
<i>no</i>
<i>YES</i>

Set Point Tracking. '*YES*' activates set point tracking. When the set point tracking is activated, set-point tracks process input when the controller is in manual. This ensures that there is no set point/process deviation when switching from manual to automatic.

<i>dr.ct</i>
<i>ACTG</i>
<i>no</i>
<i>YES</i>

Direct Acting. '*YES*' selects direct control action. '*no*' selects reverse control action.

Selections provide the following output response to input changes:

- Direct Action – increasing process input produces increasing controller calculated output.
- Reverse Action – increasing process input produces decreasing controller calculated output.

Caution. It is very important that the selected control action agrees with the specific requirements of the process. If the action is not correct, the instrument does not function as a controller. Output is driven to either 0 or 100% when the unit is switched to automatic at startup.

<i>r.U.oP.</i>
<i>no</i>
<i>YES</i>

Reverse Output. '*YES*' selects reverse output (20 to 4mA) to correspond to a reverse acting valve. '*no*' selects direct output (4 to 20mA) to correspond to a direct acting valve.

<i>SP.2</i>
<i>r.SPt</i>
<i>dUAL</i>
<i>NONE</i>

Second Set Point. '*r.SPt*' enables remote set point selection in Level 1 and enables remote input setup. '*NONE* or *dUAL*' disables prompt in Level 1.

r.SPt = Remote Set Point
dUAL = Dual Set Point
NONE = No Second Set Point

Continued on the next page...

...2.5.2 Level 6 – Enable

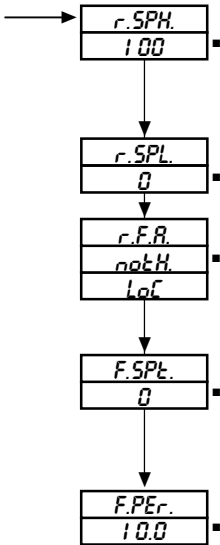

Remote Input High. Set high engineering unit value (–999 to 9999) of remote set point, ratio or bias at 20mA input.

Note. Allow for setting the decimal point position in level 5 (if required), e.g. for a required setting of 400.0 enter 4000.

Remote Input Low. Set low engineering unit value (–999 to 9999) of remote set point, ratio or bias at 4mA input.

Remote Input Fault Action. Use / to display and make choice. *noth*. (nothing) allows failed mA input to determine remote set point. *Loc* (local) leaves controller in auto mode with local fault value upon detection of mA input failure.

Remote Input Fault Value (Local). Set local fault value of remote input (limited by local set point, ratio or bias limits) (–999 to 9999). Can be returned to remote input value after fault is corrected and acknowledged.

Fault Detection Level Percentage. Set percent of mA input span used for fault detection (0 to 100%) – see Section 2.5.4, page 17.

2.5.3 Level 5 – Input

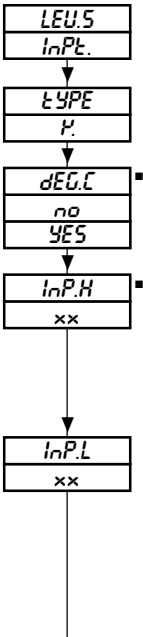

Scroll to begin input setup.

Type Thermocouple. *J*, *P*, (K), *E*, *r*, *S*, *t*, *b* or *n*. Select type connected to the process input terminals.

Degrees Celsius. ‘*YES*’ selects Celsius. ‘*no*’ selects Fahrenheit.

Input High Value. Set high value of electrical process input. Ranges for high value settings are:

- milliamp – 5.00 to 20.00mA d.c.
- millivolt – 10.0 to 150mV d.c.
- Volt – 0.1 to 5.00V d.c.

Input Low Value. Set low value of electrical process input. Ranges for low value settings are:

- milliamp – 4.00 to 19.00mA
- millivolt – 0.0 to 140mV
- Volt – 0.00 to 4.90V.

Continued on the next page...

...2 SETUP

...2.5.3 Level 5 – Input

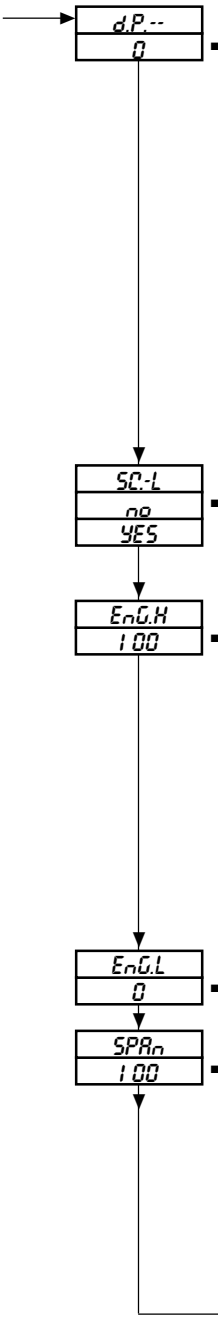

Decimal Point. Use / to position decimal point (0., 0.0, 0.00, 0.000 for mV, mA, V and 0., 0.0 for RTD and thermocouple). Positioning of the decimal point in this level sets the decimal location for all levels as follows (noted in secondary display):

- Level 6 – Remote set point limits and fault value.
- Level 5 – Process input engineering units and span
- Level 4 – Local set point limits, dual set point limits and start value and retransmission process variable engineering units
- Level 3 – Process and deviation alarm trip-points and alarm hysteresis engineering units
- Level 2 – Bias function engineering units

Setting the decimal point to the tenths (0.1) position limits the thermocouple temperature readout to 999.9 degrees. Should the temperature rise over 1000 degrees, the display would read 999.9 until it fell below that level.

Square Law. Scrolling when *YES* selects square law linearization of input. Scrolling when *no* means no square law linearization. When square law linearization of input is selected, the low value of the engineering units range defaults to zero.

Engineering Units High. Set engineering units that correspond to high input of *lnP.H.* (-999 to 9999).

Settings for high and low engineering unit values are determined by the specific process measurement requirement. For example, if the process input signal is 4 to 20mA d.c. and this signal represents flow measurement of 0 to 580 gallons/sec., the engineering unit low setting would be 0 and the high setting would be 580 corresponding to the 4 to 20mA current input.

Engineering units can be used as a linear multiplier. By setting the values at 0 and 58, for example, a scale factor of 10 is achieved. With proper use of the decimal point, the units could be set a 0 and 0.58 for a scale factor of 1000.

Engineering Units Low. Set engineering units that correspond to the low input value.

Span. Set span for controller gain calculation. This value represents the range over which 100% of the proportional band, set in Level 2, is calculated.

Process input span in Engineering units is the recommended setting for mV, V, and mA. The span entry required for all thermocouple and RTD inputs is 100.

The proportional band setting in Level 2 (0.1 to 999.9%) provides controller gains ranging from 1000, for a 0.1% proportional band, to 0.1, for a 999.9% proportional band.

Continued on the next page...

...2.5.3 Level 5 – Input

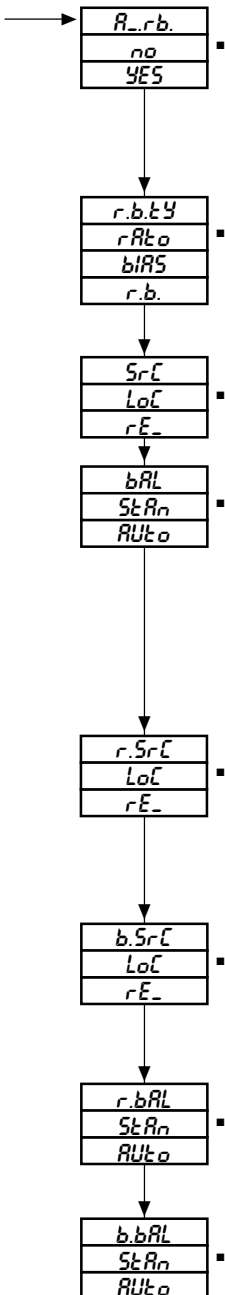

A/M Ratio Bias. 'YES' enables A/M Ratio Bias station. 'no' disables. Scroll to continue from YES or to beginning of this table from 'no'. With this option enabled, ratio and bias values (local or remote) are applied to the process variable to directly affect output without using the P.I.D. algorithm (no set point is used). The output calculation is: Output = Process Variable x Ratio + Bias.

Ratio Bias Type. Use / to display type ratio bias station choices.

- r.Rt.o = Ratio Only Station
- bIAS = Bias Only Station
- r.b. = Ratio Bias Station

Source. Use / to display source choices for ratio only or bias only types. Lo.L = Local. rE_- = Remote (requires remote input option).

Balance. Use / to display balance choices for ratio only or bias only types.

- St.Rn = Standard. Causes a bump in the output when switching from manual to auto.
- AUt.o = Auto. Results in a bumpless transfer in the output when switching from manual to auto. A new ratio or bias value is recalculated as follows:
 New Bias Value = $DUt - PU$.
 New Ratio Value = DUt / PU .

Ratio Source. Use / to display ratio source choices for Ratio Bias Type type.

- Lo.L = Local,
- rE_- = Remote (option).

If ratio is remote, bias must be local as only one remote source is allowed.

Bias Source. Use / to display bias source choices for Ratio Bias Type.

- Lo.L = Local.
- rE_- = Remote (option). If bias is remote, ratio must be local.

Ratio Balance. Display ratio balance choices for Ratio Bias Type. Only one balance source may be auto.

Bias Balance. Display bias balance choices for Ratio Bias Type.

...2 SETUP

2.5.4 Level 4 – High and Low Limit

LEU.4
Hi.Lo

Scroll to begin hi-lo limits setup. (/ change level.)

oP.Hi
100.0

Output High. Set limit in % of output span (10.0 to 100.0). Maximum value of 100% applies to relay outputs. Maximum value for mA outputs is 110% (=21.6mA).

oP.Lo
0.0

Output Low. Set limit in % of output span (0 or -8% to high limit less 0.1). Minimum value of 0% applies to relay output; minimum value for mA output is -8% (= 2.72.mA).

SP.H
100

Set Point High Limit. Enter local set point high limit ($SP.L$ to 9999; cannot be lower than set point low limit).

SP.L
0

Set Point Low Limit. Enter local set point low limit (-999 to $SP.H$; cannot be higher than set point high limit).

SP.2
rSPt
dURL
NONE

Second Set Point. Scrolling when 'dURL' enables dual set point selection in Level 1 and enables dual set point setup. Scrolling when 'rSPt' or 'NONE' disables dual set point.

rSPt = Remote Set Point

dURL = Dual Set Point

NONE = No Second Set Point

SP.2.H
100

Dual Set Point 2 High. Enter limit ($SP.2.L$ to 9999 cannot be lower than dual set point 2 low limit).

SP.2.L
0

Dual Set Point 2 Low. Enter limit (-999 to $SP.2.H$; cannot be higher than dual set point 2 high limit).

SP.2
0

Dual Set Point 2 Start Value. Enter value $SP.2.L$ to $SP.2.H$.

diG.
InPt

Digital Input. Point of entry (use).

Lk.oE
no
YES

Lockout. 'YES' locks out front panel changes to $R.t.o._$ digital input action. 'no' allows changes from front panel (disable lockout) which may conflict with digital input state.

di.FC
R.t.o._
L.t.o.r
R.RcK
F.d.SP*
noEH

Digital Input Function. Display function (auto/manual, local, remote, global alarm acknowledge, fixed dual set point, or none). Scroll to select function and access related displays. Enable function in Level 1 at $d.EbL$.

*This choice disables dual set point $d.SP.E$.

Continued on the next page...

...2.5.4 Level 4 – High and Low Limit

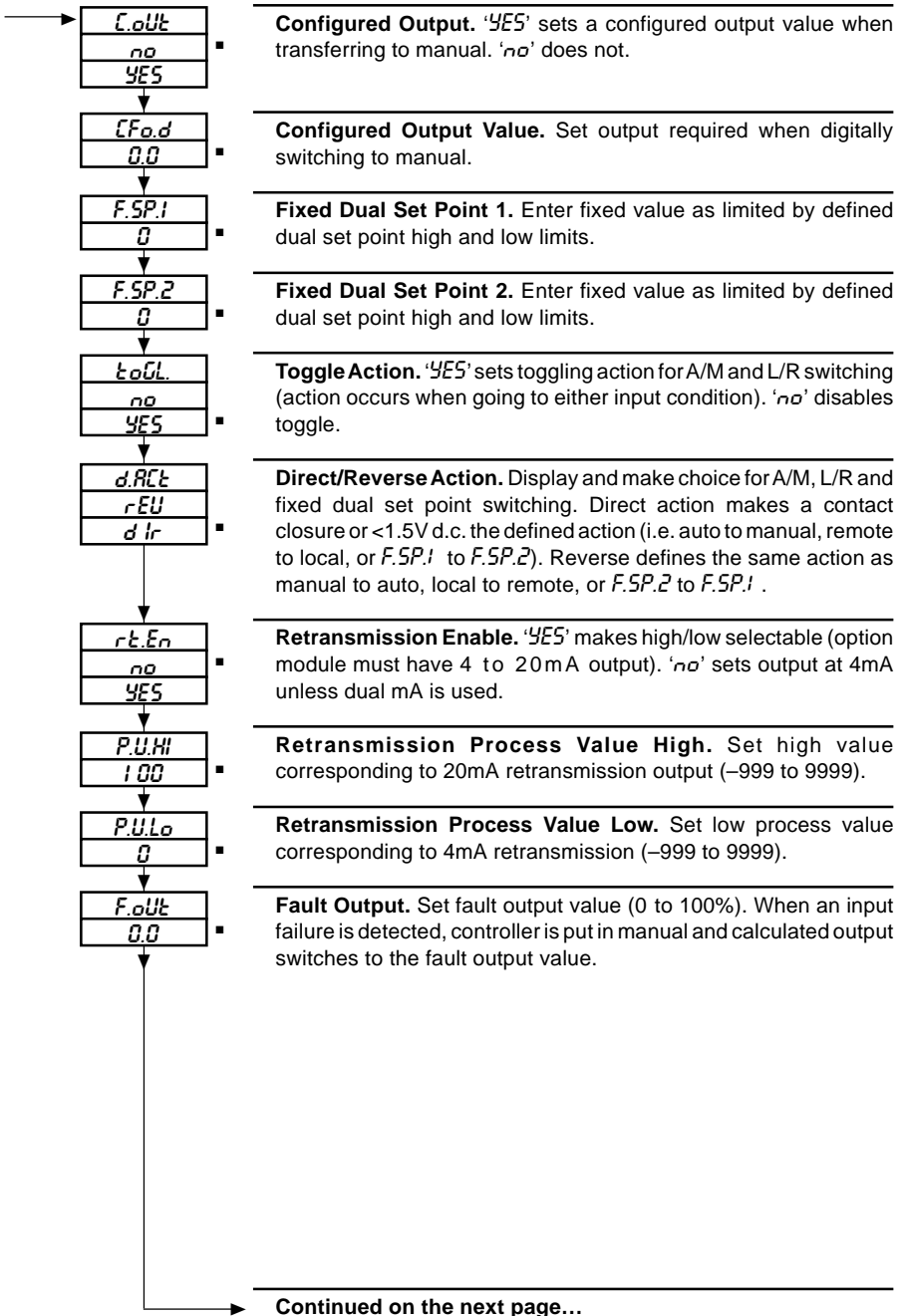

...2 SETUP

...2.5.4 Level 4 – High and Low Limit

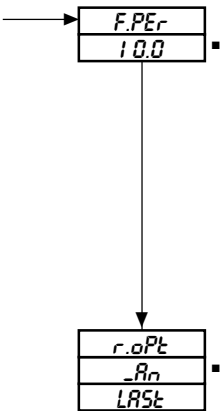

Fault Detection Level Percentage. Set per cent of input span used (0 to 100%) to determine fault detection level. The percentage of input level used to generate a fault condition is calculated using the configured input span. Limits on detection levels are:

Volt = -0.005 to 6.00 V
 millivolt = -10.00 to 193mV
 milliamp = 0.03 to 49.6mA.

For example, at the 10% level a fault in a 0 to 5V input (span is 5V) triggers at -0.005 and 5.5 V, and at the 20% level triggers at -0.005 (lower limit) and 6.0V. A 4 to 5V input with a span of 1 V would trigger a fault at 3 and 6 V with a 100% *F.PEr* value.

Recovery option. Display and make recovery option choice. Selecting *_Rn* (manual) causes the instrument to remain in the manual mode after the input failure is corrected. Selecting *LRSr* returns the instrument to auto mode after the input failure is corrected.

2.5.5 Level 3 – Alarm

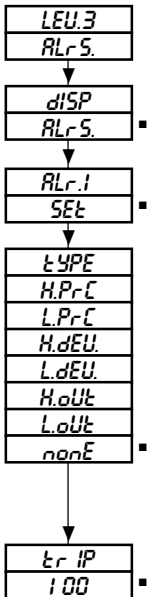

Scroll to begin alarm setup.

Display Alarms. Point of entry (use).
 Scroll to continue.

Alarm 1 Setup. Point of entry (use). Scroll to advance to **Alarm 2 Settings.**

Alarm Type. Use to display type. Scroll to select alarm type and continue. Alarm types are: High Process, Low Process, High Deviation, Low Deviation, High Output, Low Output. High-High and Low-Low alarms are also possible by using a second high or low type alarm and setting its trip point beyond the other high or low alarm trip point. It must be known which display alarm was the high-high or low-low alarm, as the alarm message and acknowledgement displays are the same for both high and high-high or low and low-low. Alarm priority and alarm relays can be used to help distinguish these alarms.

Trip Point. Set value in engineering units for selected alarm type.

H.PrC = -995 to 9999
L.PrC = -999 to 9995
H.dEU. = 1 to 9999
L.dEU. = 1 to 9999
H.oUt = Level 4 output limits
L.oUt = Level 4 output limits

Continued on the next page...

...2.5.5 Level 3 – Alarm

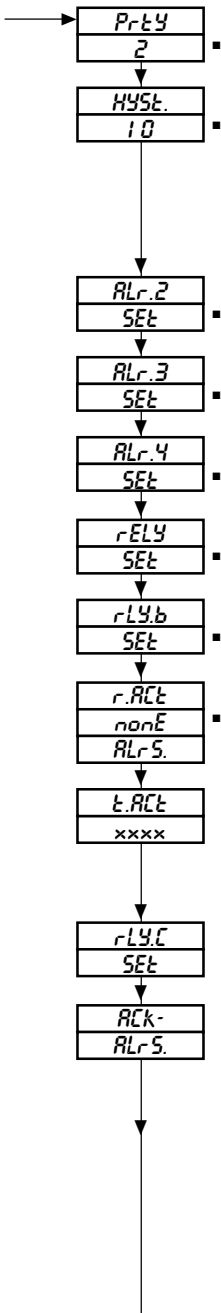

Alarm Priority. Set priority at 1 (higher) or 2 (lower).

Alarm Hysteresis. Set hysteresis (dead band) in engineering units. This parameter provides an adjustable dead band at the alarm trip point. The alarm output turns off only after the process value has moved into the safe region by an amount equal to the dead band setting. The dead band setting applies to both process and deviation alarms.

Alarm 2 Setup. Point of entry (use). Setup same as Alarm 1. Scroll to Alarm 3.

Alarm 3 Setup. Point of entry (use). Setup same as Alarm 1. Scroll to Alarm 4.

Alarm 4 Setup. Point of entry (use). Setup same as Alarm 1. Scroll to Relay Set.

Relay Setup. Point of entry (use). Scroll to Alarm Acknowledge settings.

Relay B Setup. Point of entry, if installed. Scroll to Relay C Setup.

Relay Action. Select relay action as either none or alarms.

Trip Action. Select desired combination of four display alarms (Alarm 1, 2, 3, and 4 setup) to be used for relay trip action. Choices are: 1, 2, 3, 4, 12, 13, 14, 23, 24, 34, 123, 124, 134, 234 or 1234.

Relay C Setup. Point of entry, if installed (use). Scroll to alarm acknowledge.

Acknowledge Alarms. Point of entry.

Continued on the next page...

...2 SETUP

...2.5.5 Level 3 – Alarm



Acknowledge.

'NONE' – no alarm acknowledgement.

'NO_r_' (normal) – selects acknowledge feature. With this feature, an alarm message alternates with the process variable display until the alarm is acknowledged. If the alarm state remains after acknowledgment, the process variable display flashes. Normal operation returns when both the alarm ceases and the alarm is acknowledged. Acknowledgment of an alarm does not change the alarm output. The alarm output follows the alarm state: it turns on when the alarm trips, and turns off when the alarm state ceases.

'LtCH' (latch) – selects the latching response for an alarm relay (operation of the alarm message is the same as described above for alarm acknowledge). Operation of the alarm output is as follows: the alarm output is turned off only by acknowledgment of the alarm. If the alarm state ceases before acknowledgment, the alarm output remains on until acknowledged.

2.5.6 Level 2 – Tune

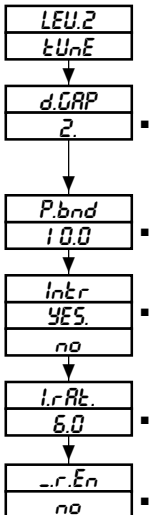

Scroll to begin tune setup.

Differential Gap.

Set gap value in engineering units that represents the deviation between set point and process where the output relay is off. For On/Off Control only.

Proportional Band.

Set % band (0.1 to 999.9%). Input change in % span, that drives output through full span.

Integral Response.

'YES' selects integral (reset) response.

Reset Rate.

Set reset rate (0.1 to 120.0 rpt/min).

Manual Reset Enable.

'YES' enables a fixed manual reset value as set in next step. 'no' enables a calculated manual reset value to be set when the controller is switched from manual to auto. The calculated manual reset value (MR) is determined as follows:

$$MR = \text{Output} - (\text{Gain} \times \text{Error})$$

Continued on the next page...

...2.5.6 Level 2 – Tune

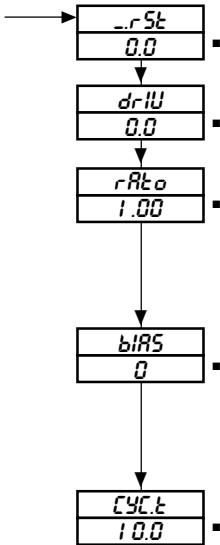

Manual Reset Value. Set value (0 to 100%, or 0.0 to 100.0%). A value of zero (0) turns manual reset off.

Derivative Response. Set rate time = 0 to 999.9 sec.

Ratio Value. Set ratio value (0.01 to 99.99) applied to the remote set point or local ratio applied to the process variable for A/M Ratio Bias (remote ratio for viewing only). If the ratio function is not required, set ratio value to 1. For local A/M Ratio Bias, this value represents the initial value and can be changed in Level 1.

Bias Value. Set bias value (–999 to 9999) applied to the remote set point or local bias applied to the process variable for A/M Ratio Bias (remote bias for viewing only). If bias is not required, set bias value to 0. For local A/M Ratio Bias, this value represents the initial value and can be changed in Level.

Cycle Time. Set cycle time (1.0 to 300.0 sec). Cycle Time value determines the period of oscillation for the output relay when time proportioning control is used. For On/Off control, cycle time applies only to manual operation.

2.5.7 Level 7 – Diagnostics and Temperature Calibration

LEU7
dIRG

Scroll to access diagnostic tests and temperature calibration procedure.

↓
L.tSt
no
YES

Lamp Test. Scrolling starts the lamp test (lamps are illuminated temporarily).

↓
brGt
AJSt

Brightness Adjustment. Use ▲ / ▼ to adjust the display brightness.

↓
t.CAL
no
YES

Temperature Calibration. Scrolling from 'YES' allows a temperature calibration correction.

↓
32.0
xx

Process temperature (main display) and calibration correction (secondary display). Use reference standard thermometer or ice bath for reference temperature (+15° to -15°). Select correction that eliminates error to reading on main display. Apply correction input gradually and allow response interval after each input change. Scroll to save correction.

**Notes.**

1. Allow controller with thermocouple to warm up for at least ½ hour to ensure that the cold junction compensator has reached a stable temperature.
2. Ensure that any length of thermocouple extension wire, or RTD lead wire, which is to be used in the installation is connected for this procedure. If it is not possible to use the extension or lead wire, an equivalent resistor must be used.
3. When using a melting ice bath as a temperature standard, put melting ice and water mixture in a thermos to establish a precise 32°F (0°C) which is within the range of most thermocouples and RTDs used with the controller.
4. An alternative method for an RTD is to connect a 100Ω 0.1% resistor to the RTD lead wires in place of the actual RTD. The Primary display should read 32°F (0°C) since a standard RTD (DIN 3760) has a resistance of 100Ω at 32°F.

2.5.8 Level 8 – RS485 Interface

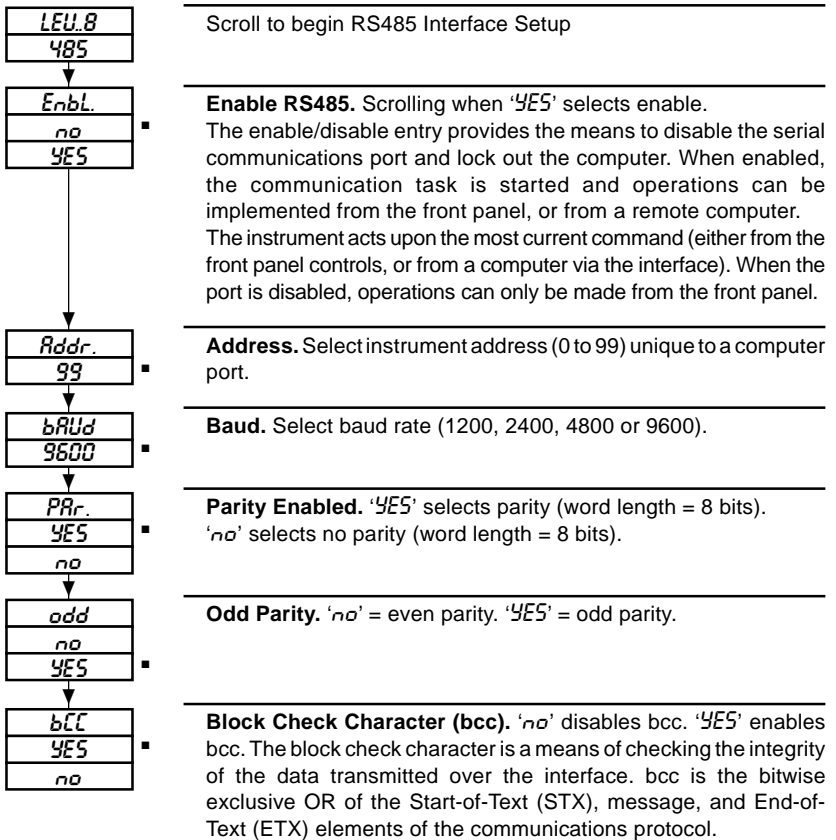

3 OPERATION

3.1 Control Keys

There are four operator control keys.

Scroll: Press as directed in instructions to advance through setup displays or Level 1 displays. Used in Level 1 to switch between local and remote or dual set point, or access autotune.

Up: Press to move to higher level when *LEU*. (Level) display is present. Used in conjunction with the key to enter setup values, enter access codes and adjust operating values. Used to enter a 'YES' response during some setup and operating procedures. Used to increase output when controller is in manual. Used in Level 1 to acknowledge alarms.

Down: Press to move to lower level when *LEU* display is present. Used in conjunction with the key to enter setup values, enter access codes and adjust operating values. Used to enter a 'no' response during some setup and operating procedures. Used to decrease output when controller is in manual.

Auto/Manual: Press to change operating mode between automatic and manual control. key may be disabled in Level 4 when external toggle digital input and lockout are enabled. 'MAN' indicator is illuminated in manual mode and is extinguished during automatic mode.

3.2 Startup

When a.c. power is applied, the controller starts at Level 1 in the mode defined during setup (manual, auto or last). The power-up message *R.C./FAIL* appears, as enabled during setup, indicating that power has been off. If diagnostic messages are present, then these messages are shown next.

3.3 Operation in Automatic

The operating sequence begins as shown in Fig. 3.1 for local set point with alarms and autotune enabled or Fig. 3.2 for A/M ratio bias, or Fig. 3.3 for remote set point operation. The figures show where a scroll action is used to advance to the next display and where the and keys are used for set point adjustment, password entry, level change and to designate the remote or dual set point source.

Variations on these basic loops depend upon configuration and alarm conditions. The process/set point (or process/ratio and/or bias for A/M ratio bias station) and process/output displays are always available. When the controller is set up for on/off control, the output can have only two values, either 0% or 100%. The alarm acknowledge displays appear only if alarm acknowledge has been enabled and an alarm is active. For remote or dual set point, if enabled during setup, the sequence of progression through the set point and balance displays depends on whether the controller is in the local or remote or dual set point mode. If the digital input function is used, it can be enabled in level 1 *d.EbL /YES*. Once enabled, the display does not appear again unless the level 4 action is changed or an input failure occurs when recovery option is manual.

The code display asks for operator entry of a predetermined password. A correct password entry, per the secondary display, permits tune (or configure) access to higher levels. In addition, a correct password permits access to the autotune routine if enabled in Level 6. An incorrect entry allows read only access to higher levels.

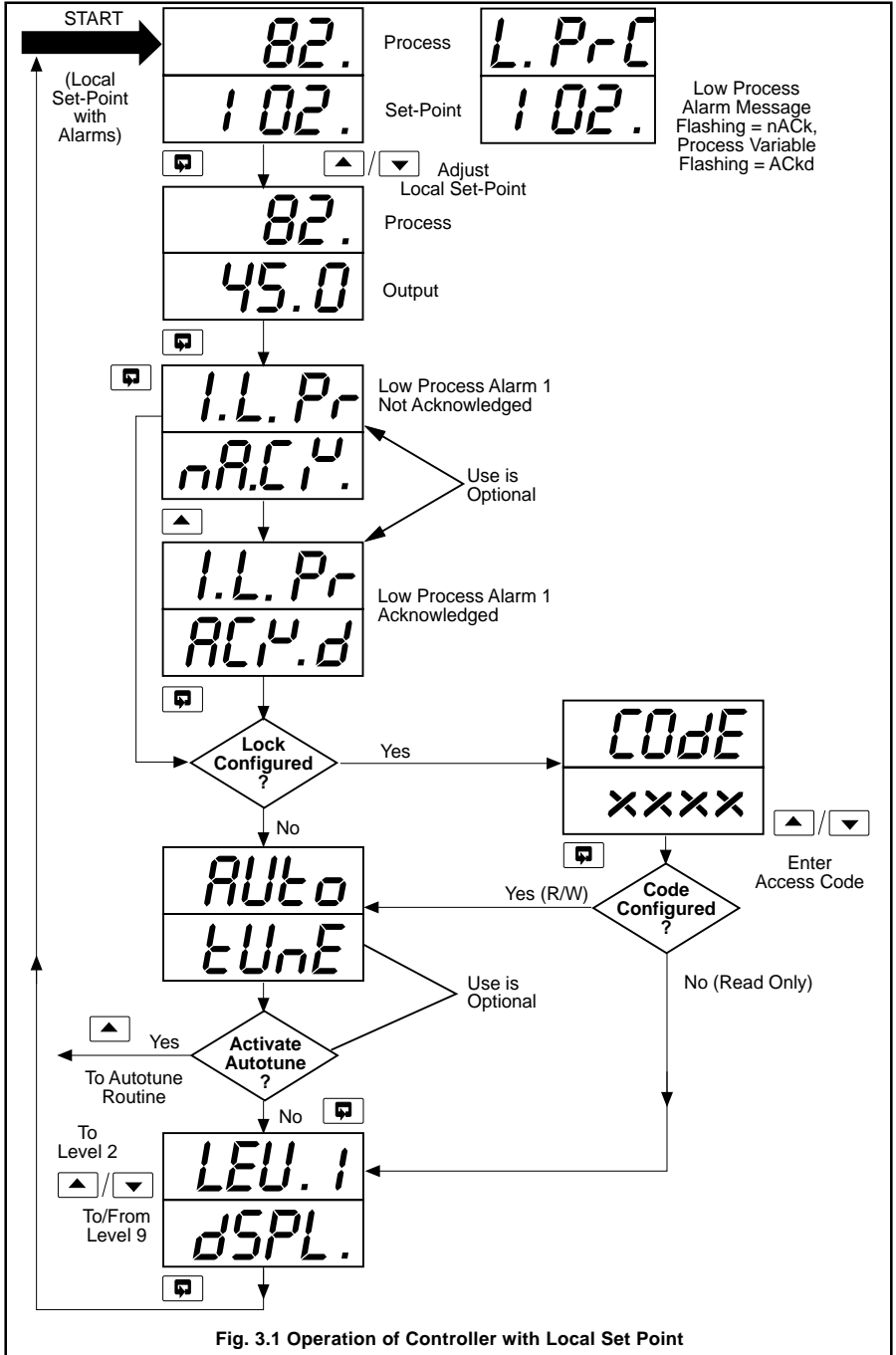

Fig. 3.1 Operation of Controller with Local Set Point

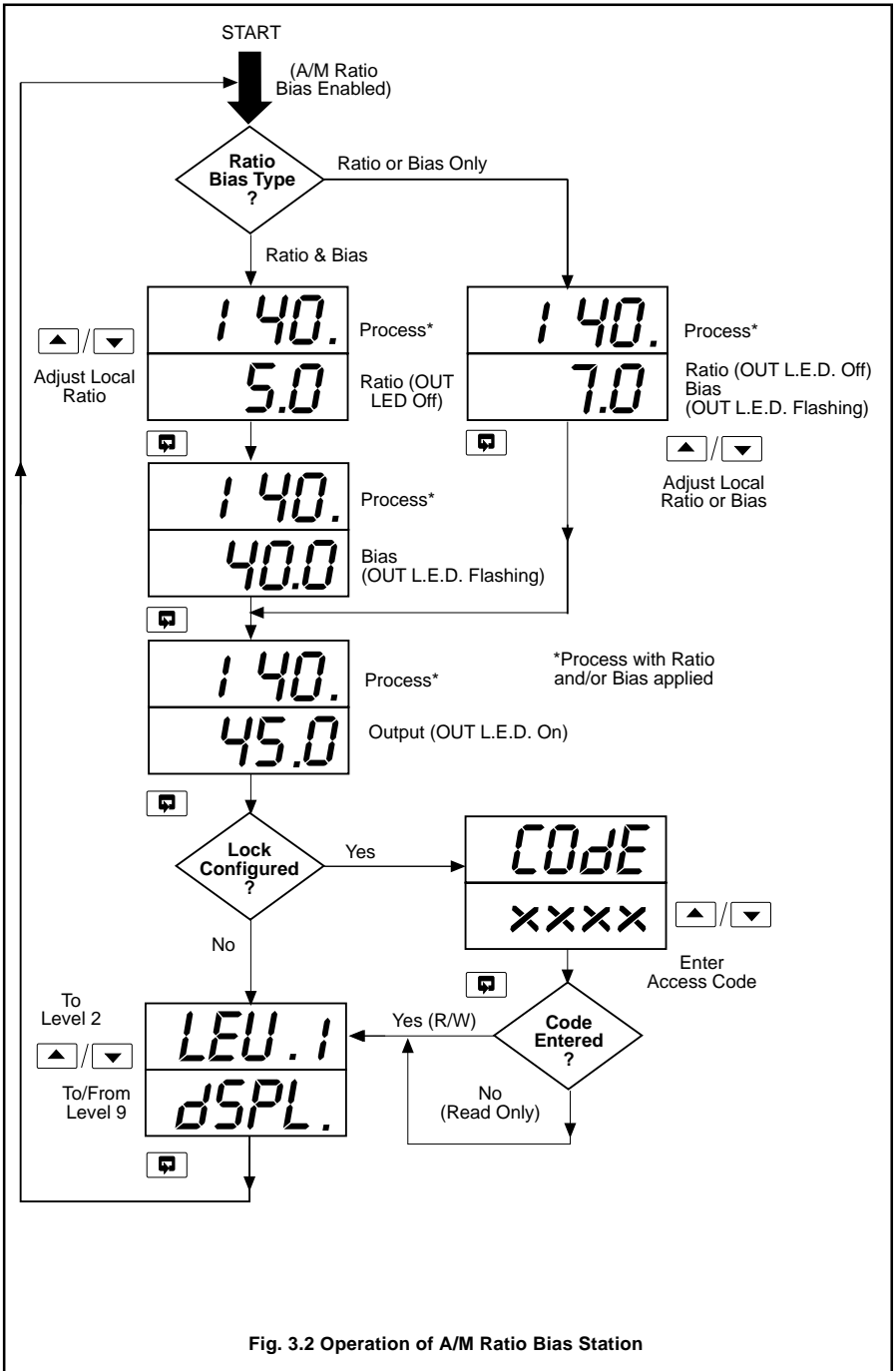

Fig. 3.2 Operation of A/M Ratio Bias Station

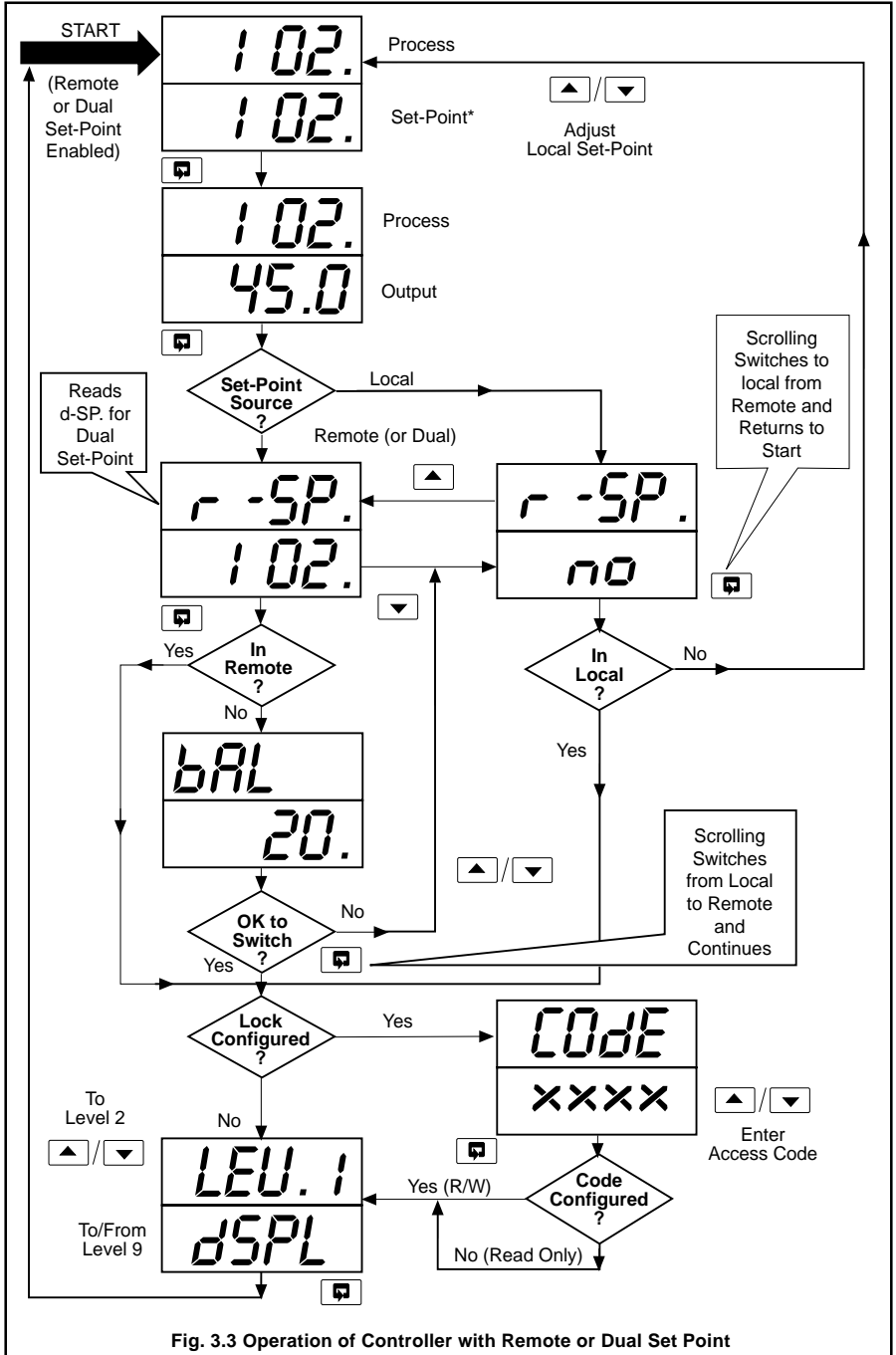

Fig. 3.3 Operation of Controller with Remote or Dual Set Point

3.4 Auto/Manual Transfer

Transfers from automatic to manual or manual to automatic are made by pressing the key, or by using the digital input, if setup. The 'MAN' indicator is illuminated in the manual mode, and is off in the automatic mode.

3.4.1 ...with Local Set Point

When the controller is operating on local set point, transfers from automatic to manual and from manual to automatic are always bumpless. After switching from local manual to local automatic, the process variable is under automatic control in response to the adjustment of local set point in the controller.

3.4.2 ...with Remote Set Point

When the controller is operating on remote set point (RMT indicator light is on), the key must be pressed twice (or digital input toggled twice) to switch to manual control. The first switch is made to automatic with local set point. The second switch is to manual operation.

3.4.3 ...with Dual Set Point

If the controller has been configured for dual set point, press the key once to switch the controller to manual operation.

3.4.4 ...with Local Set Point Tracking

If the controller has been configured for local set point tracking, the local set point tracks the process value when the controller is in manual, and the process is always at the local set point when a transfer to automatic is made regardless of set point limits.

3.4.5 ...without Local Set Point Tracking

If the controller does not have local set point tracking, the local set point and process may not be at the same value at the time of transfer from manual to automatic. The transfer is bumpless, but the response following the transfer depends on the controller setup. If the controller has integral response, the process ramps towards the local set point at the reset rate. If the controller does not have integral, the local set point/process deviation at the time of transfer is maintained. This deviation can be eliminated by using a fixed manual reset value or a calculated manual reset value, by returning to manual, adjusting output to eliminate the deviation, then switching bumplessly back to automatic with local set point.

3.4.6 ...for On/Off Control

If the controller is setup for on-off control, the bumpless transfer feature does not apply when switching from automatic to manual. When switched to manual, the on-off controller output is always initialized at 0%. The transfer is bumpless only if the automatic output happens to be at 0% when switched. Operation in manual is the same as for a time proportioning controller. When switching from manual back to automatic, operation is the same as for all other types of control.

3.5 Operation in Manual

When the controller is switched to manual, the first display seen is process/output. Output can be adjusted using the \leftarrow / \rightarrow keys. The scrolling sequence is the same as for the automatic mode as shown in Fig. 3.1 for local set point only or Fig. 3.2 when A/M ratio bias is used. The displays related to remote or dual set point do not appear in the manual mode. The controller cannot be switched to remote or dual set point from manual.

When the controller is set up for on-off control, the manual output is a time proportioning signal. This makes output continuously adjustable between 0 and 100% rather than limited to the two-state 0 and 100% values of the automatic mode. In manual, the output can be adjusted to any value needed to maintain the process at the set point.

When the controller is set up for manual reset, $r-SP$ values entered in auto or manual take effect when switching from manual to auto.

3.6 Remote/Local or Dual/Local Set Point Transfer

Remote or dual/local set point transfer is made by scrolling (press, then release key) at the points indicated on Fig. 3.3, or by using the digital input, if setup.

The transfer from local to remote (or dual) set point, using the level 1 displays, is preceded by a balance display, which shows the difference between the two values, so that a balancing adjustment may be made prior to switching. Digital input switching is immediate.

When the controller is operating on local set point the remote set point no ($r-SP$ no) and then the dual set point no ($d-SP$ no) display appears during the scrolling sequence. Only one remote source is allowed (remote or dual set point). The switch between remote/local and dual/local is the same, except dual set point can be selected and used in manual

(SP2 tracks in manual if enabled). The following description uses the remote/local switch as an example.

To prepare to switch to remote, press the key and scroll after the remote set point yes SP YES display appears. The balance display BAL xx then indicates the difference between the remote and local set points in engineering units. If the difference is acceptable, scroll switches to remote. The RMT indicator light is illuminated and the display increments to the next prompt with the controller operating on remote set point. If the balance value is not acceptable, adjustments in either the local or remote set point can be made to obtain the required balance value. To adjust the local set point, press either the \leftarrow or \rightarrow key to return to the remote set point no display. Operation can continue by scrolling to local set point.

When the controller is operating on remote set point, transfer to local is made by scrolling at the point indicated in Fig. 3.3. In remote the remote set point yes display appears in the sequence. Operation in remote can be continued by scrolling from the remote set point yes display. Balance is bypassed and the operational sequence continues. To prepare to switch to local, press the key and scroll after the remote set point no display appears. The controller switches to local, the RMT indicator light is extinguished and the display returns to process/set point. The controller is now operating on local set point.

3.7 Control Output Limiting

High and low limits on the control output are entered in setup Level 4. The output limiting function applies only when the controller is operating in automatic. In manual, the output can be adjusted to its maximum or minimum value regardless of the limit settings.

If the controller is switched to automatic after the output has been manually adjusted to exceed a limit, operation in automatic begins with an excessive output value. If the control algorithm then acts to move the output further from the limit, the limiter forces the output to remain constant. If the algorithm acts to move the output closer to the limit, the limiter allows it to act uninhibitedly. At the point where the control output is at or within the limit, the limiter function returns to normal; it simply prevents the output from exceeding either the high or low limit.

3.8 Alarms

Four display alarms and up to two alarm relays may be configured to respond to alarm conditions. The trip action on the relays may include any combination of the four display alarms. Monitoring and acknowledging alarms are basic operator activities. Acknowledgment may or may not be required depending on the alarm setup in Level 3. During power-up, the alarm relay(s) remain powered-down until an accurate process input reading is made (about 2 seconds).

3.8.1 Alarm Messages

An alarm is active when the process input ($P_r I$), control output (σU_t), or deviation value (dEU) exceeds its configured alarm limit. The front panel alarm message for the appropriate high (H) or low (L) alarm turns on and flashes alternately with the process display. Any configured alarm output relay is also activated. The alarm remains on until the process input returns to a value within the preset limits; it is then extinguished. The possible alarm messages are: $H.\sigma U_t$, $L.\sigma U_t$, $H.P_r I$, $L.P_r I$, $H.dEU$ and $L.dEU$.

3.8.2 Alarms with Acknowledgment

An alarm message flashes until the alarm is acknowledged if acknowledgment is enabled. Alarm messages are a combination of the alarm message set number (1 to 4), the high or low condition (H or L), the type (P_r for process, σP for output, and dU for deviation) and the acknowledged condition. A sample message that has not been acknowledged would read as $i.H.P_r n.ACK$. If the alarm condition still persists at the time of acknowledgment, the message flashing mode changes to a process variable flashing mode to show that the alarm has been acknowledged but is still present. When the alarm condition finally stops, the display stops flashing and returns to normal.

If there is an alarm at one limit that has not been acknowledged (e.g. high), and then the process subsequently trips the alarm at the other limit (low, high-high, or low-low), only the latest alarm flashes. If the low alarm remains when the alarm is acknowledged, the high alarm is extinguished and the low alarm assumes a steady-on condition. Acknowledgment of an alarm does not change the alarm output. The alarm output follows the alarm state; it turns on when the alarm is tripped and turns off when the alarm state ceases.

With latch, the alarm output can be turned off only by acknowledgment of the alarm. If the alarm state ceases before acknowledgment, the alarm output remains on until acknowledged.

3.8.3 Acknowledgment Procedure

Operate the \square key until the $i.H.P_r n.ACK$ display (or equivalent) appears. Press the \square key to acknowledge the active alarm or use the digital input if available. At that point, the display changes to $i.H.P_r ACKd$. Press the \square key to pass over the alarm without acknowledging it.

3.9 Manual Tuning – Fig. 3.4

The following procedure for tuning a controller is applicable to controllers set up for P (Proportional), P.I. (Proportional plus Integral), P.D. (Proportional plus Derivative), and P.I.D. (Proportional plus Integral plus Derivative) responses. If a recorder is available to record the process variable, it is helpful in determining optimum controller settings.

- 1) Start-up controller in manual mode.
- 2) When process and set point are together, switch to automatic mode.
- 3) For P.I., P.D. and P.I.D. controller, turn off integral and derivative responses as follows:
 - a. Access Level 2 using `↑` and `↓` keys.
 - b. In Level 2 scroll to `P.band` and use `←` / `→` keys to set value at `100%` (gain of 1).
 - c. Scroll to `Int.r` and select `no` to turn off integral response.
 - d. Scroll to `dr.der` and set value at 0 to turn off response
 - e. Return to Level 1. This procedure has removed all but proportional response from the system.

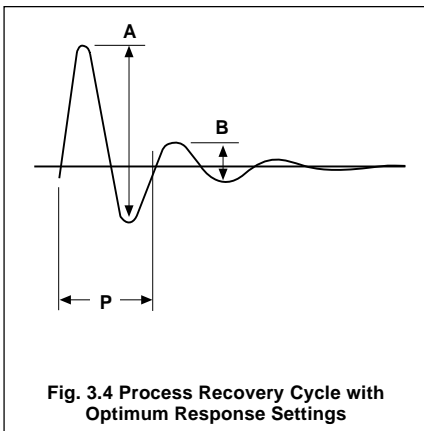

- 4) Create a disturbance in the system by adjusting the set point a small amount either up or down. The resulting disturbance must be large enough to observe, but not so large that it causes signal saturation at any point in the control loop. This means that the controller output should be within its working range of 0 to 100% (4 to 20mA) at all times during the recovery and the process variable change during recovery should be small enough to be considered linear about the set point.
- 5) Hold the set point at this value until the process variable begins to move, then return the set point to its original value.
- 6) Compare the recorded oscillation with Fig. 3.4. Cycle B should be approximately $\frac{1}{4}$ of cycle A as shown in the figure. If it is not, change the proportional band setting and repeat Steps 4 and 5. Decreasing the proportional band setting (increasing gain) increases cycle B relative to cycle A. If the controller has proportional response (P) only, no further adjustment is required. If the controller has two or three responses, proceed to Step 7.
- 7) Measure the period (P) of oscillation in minutes. The period is the time required for one complete cycle.
- 8) Calculate I (integral) and D (derivative) values as follows:
 - a. Controller with P and I responses:
 $I = P$ (Minutes)
 - b. Controller with P and D responses:
 $D = P$ (Minutes) / 8
 - c. Controller with P, I, and D responses:
 $I = 1.5 / P$ (Minutes)
 $D = P$ (Minutes) / 6.
- 9) Access Level 2 and adjust settings to values determined in Step 8.
- 10) Repeat Steps 4, 5, and 6 to obtain optimum gain setting.

3.10 Automatic Tuning – Fig. 3.5

Automatic tuning (autotune) is an on-demand user activated feature which automatically calculates either P.I. or P.I.D. response values based on process reaction during an autotune cycle. This is accomplished by manipulating the controller output to effect a periodic response by the intended process. The autotune cycle requires 6 process oscillations to determine the tuning parameters. The controller output and a typical process response are as shown in Fig. 3.5. After successful completion of the autotune cycle, calculated response values are entered into the control algorithm calculations and the controller is operational in the automatic mode with the new values. The parameter values may be observed and/or changed in Level 2. Automatic tuning is not applicable to on-off control.

3.10.1 Setup Procedure

In order to use the autotune feature it must be enabled for use in Level 6. Section 3.10.2 explains various rules and guidelines which apply to autotune setup. Autotune setup also requires user input to define certain operating parameters and constraints. Section 3.10.2 provides a detailed description of the five setup parameters.

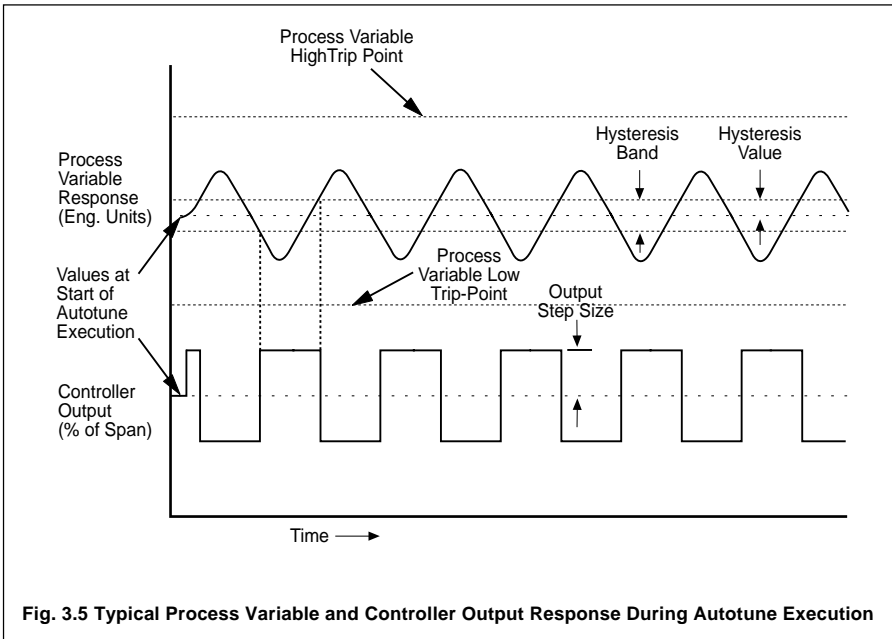
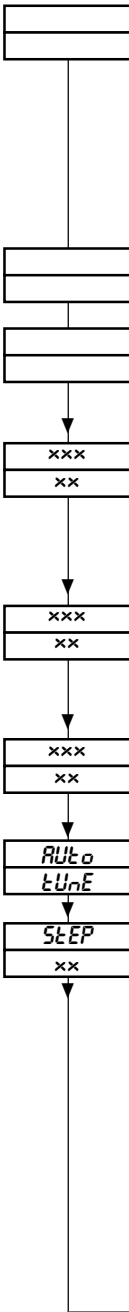

Fig. 3.5 Typical Process Variable and Controller Output Response During Autotune Execution

3.10.2 Autotune Setup Procedure



Installation and Setup Check. Installation and Setup must be completed before executing autotune. Note the following:

- Output limits entered in setup Level 4 are applied during autotune execution.
- Digital input must be set to Nothing (*noth*) in setup Level 4 or not enabled in Level 1 to make autotune visible in Level 1.
- Correct control action is essential for successful autotune execution.

Control Action Check. Check that control action (direct or reverse) is properly defined for the application, and properly set per Level 6.

Operating Mode. If automatic mode is selected, advance to auto tune activation. The output and process values must be as stable as possible before activating.

Adjust Starting Output (manual only). Scroll in Level 1 to obtain process/output display. Use / to adjust output to a safe starting value for the process. Ramping the output should be slow enough to allow process response to the change without overshooting the set point.

Make Process Available. If necessary, open block valve ahead of control valve or perform any other procedure required to make the process available, such as starting a pump, turning on a power supply, etc.

Set Final Output Value. With control in manual, adjust output to bring process value to the normal operating set point. The closer the process is to the set point, the more effective the autotune cycle.

Autotune Activation. Scroll in Level 1 to obtain *AUT0/tUNE* display, then use to enter autotune cycle.

Output Step Size. Set output step size (0.1 to 50.0). Scroll to continue.

The controller output changes by plus and minus the output step size from its initial starting value when autotune is executed (refer to Fig. 3.5). This value should be large enough so that the amplitude of the process variable excursions is at least 4 times larger than the hysteresis parameter. This allows the best possible response data. The output step size should also be small enough to avoid crossing either of the process variable trip-points.

Continued on the next page...

...3 OPERATION

...3.10.2 Autotune Setup Procedure

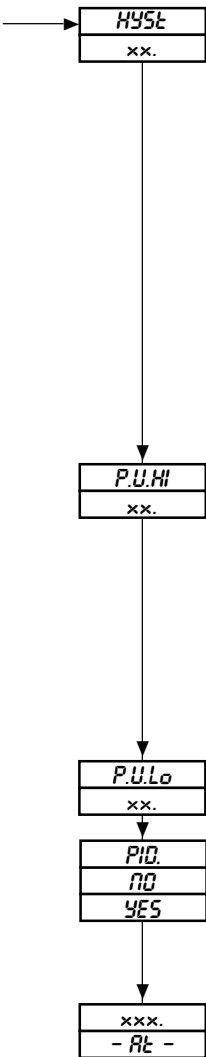

Hysteresis Value. Set hysteresis value (0.1 to 999.9, 0.01 to 99.99 or 0.001 to 9.999). Scroll to continue or press and the key to return to *SEtEP*.

The hysteresis value is used in determining when to change the controller output value (refer to Fig. 3.5). When the process variable crosses the hysteresis band (plus and minus the *HYSE* value), the controller output changes by plus and minus the *SEtEP* value from its initial starting value. The hysteresis value must be set so that it is larger than the noise in the process variable signal, allowing the best possible response data.

Caution. The value of the hysteresis parameter must be greater than the process noise value, including any contribution of time proportioning cycling to process signal noise. If hysteresis does not exceed noise, the autotune calculations may be inaccurate.

Process High Trip Point. Set high process trip point. Scroll to continue or press and hold the key to return to *SEtEP*. (Remember: the range shown is for the units decimal position.)

The process value must be between the high and low trip point values when autotune is activated. If the process value exceeds one of these, the autotune cycle shuts itself off by going to the manual mode and returning the controller output to the value it was at when autotune was activated. These high and low values are desired trip points for canceling autotune execution.

Process Low Trip Point. Use / to set low process trip point. Scroll to continue or press and hold the key to return to *SEtEP*.

Parameter Tune Selection. = *NO* (P.I. tuning). = *YES* (P.I.D. tuning).

Scroll to start autotune execution and continue. Autotune can be canceled by pressing the key.

Autotune Execution. Autotune execution proceeds automatically. No operator activity is required unless a failure or caution message appears.

3.10.3 Autotune Completion

Generally, autotune results in successful calculation of tuning constants. When a completely successful autotune cycle is completed, the controller is in the automatic mode using the newly calculated tuning constants, and displays the process variable and the controller set point on the digital displays. If autotune was activated while in the automatic mode, or in manual without set point tracking, the set point is at the same value it was at prior to autotune. If autotune was activated while in the manual mode and set point tracking is enabled, then the set point is at the last process value before the execution of the autotune cycle. The calculated tuning constants may be reviewed and manipulated by entering Level 2.

Autotune completion may be successful but a warning message ("ΕΠΙΣΤΑΣΗ") may be displayed. The controller functions as if a completely successful autotune occurred except for the warning message.

Autotune execution may result in a cancellation error message. In this case, the controller is put in the manual mode and the output value is the starting value at the execution of autotune. An error message is displayed on the digital displays.

3.10.4 Manual Cancellation During Setup

Pressing the **ESC** key at any time during setup of the autotune parameters cancels the cycle and makes a bumpless auto/manual mode change. If the controller is in manual when the cancellation is executed, the controller stops the autotune cycle and switches to automatic. If automatic is not acceptable at this time, pressing the **ESC** key again bumpless transfers back to manual and the controller output can be manipulated with the **NUM** / **KEY** keys. If placing the controller in automatic is totally undesirable at this time, continue autotune setup and cancel (press the **ESC** key) immediately after execution. A cancellation during execution places the controller in manual.

If the controller is in automatic mode when the cancellation is executed, the controller cancels the autotune cycle and changes to manual mode. The controller output value is at the last automatic calculated value prior to the cancel execution. The controller output can be manipulated with the **NUM** / **KEY** keys, or pressing the **ESC** key again bumplessly transfers back to automatic mode and the controller uses the tuning constants that existed prior to autotune activation.

3.10.5 Manual Cancellation During Execution

Pressing the **ESC** key to cancel the autotune cycle during execution by the controller, prevents completion and places the controller in manual. The controller output is changed to the starting output value prior to the execution of autotune. The output can be manipulated using the **NUM** / **KEY** keys, or the controller can be placed in automatic by pressing the **ESC** key again. If placed in automatic, the controller uses the tuning constants that existed prior to autotune activation.

3.10.6 Autotune Restart

Autotune can be reactivated at any time after a cancellation. Repeat the setup procedure in Section 3.10.2.

3.10.7 Automatic Cancellation and Diagnostics

The controller may cancel the completion of an autotune execution or may allow successful completion while providing a caution prompt to the operator. There are a series of two display prompts on the digital displays. The first prompt informs the operator that either an autotune cancellation (failure) or a caution has occurred. Pressing the **ESC** key when this first prompt occurs provides a second prompt that allows the operator to determine what should be done to obtain a completely successful autotune. Refer to Section 3.10.8 for these prompts and their definitions. Refer to Section 3.10.9 for restart or caution instructions.

...3 OPERATION

3.10.8 Autotune Diagnostic Displays and Definition

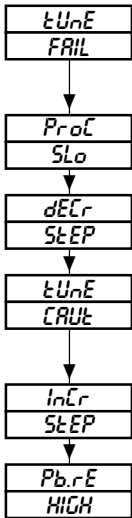

Autotune Failure. Autotune execution has been canceled, the controller is in manual, and the output is at the starting output value. A *Proc SLo* or a *dECr StEP* message follows.

Process Slow. Autotune does not work on this process because it is too slow.

Decrease Step. The process has exceeded one of the configured process trip points.

Autotune Caution. Autotune execution completed and new turning constants are being used, but an *InCr StEP* or a *Pb.rE HIGH* message follows.

Increase Step. The ratio of process oscillation to hysteresis value is too small for best results.

Proportional Band or Reset High. The controller is using the high limit for proportional band or reset.

3.10.9 Autotune Restart Instructions

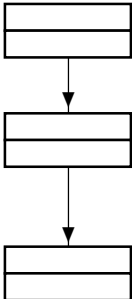

Decrease Step (Autotune Failure). Restart autotune with a smaller output step size or expand the high and low trip point of the process variable.

Increase Step (Autotune Caution). Check tuning constants in Level 2 setup. If desired, restart autotune with a larger output step size or a smaller hysteresis value. Hysteresis must be at least equal to, and preferably greater than, process noise.

Proportional Band or Reset High (Autotune Caution). Check tuning constants in Level 2 setup. The controller is using the newly calculated constants. Because of process characteristics, restart is not likely to improve tuning constant calculations.

4 DIAGNOSTICS

4.1 Input Failure and Power Failure Detection

The fault detection level for volt inputs is determined by the percent of volt input span value entered in Level 4. If there is a process input signal failure (terminals 1, 2 and 3), the controller responds as follows:

- If the recovery option is manual, the controller in the automatic mode is forced to manual with local set point and the output value is switched to the fault output value. The input failure must be corrected and acknowledged in Level 1 before the controller can be placed back into auto.
- If the recovery option is last, the controller in the automatic mode is forced to manual with local set point and the output value is switched to the fault output value. The input failure, when corrected, is cleared and the controller is automatically placed back into auto.
- In the manual mode, the controller is not forced to a fault output. The ramp keys remain functional. The input failure must be corrected and acknowledged in Level 1 before the controller can be placed back into auto.
- Displays flash and a diagnostic message is generated. Refer to Section 4.3. If the digital input function was enabled in Level 1, it is reset back to *d.EbL no.*

If there is a power failure or shutdown, the relays fail-safe by going to their alarm state. Upon restart, the displays show *R.C. FAIL* if the message was enabled in Level 6. Refer to Section 4.4. During power-up, the relays remain in their alarm state until an accurate process input reading is made (about 2 seconds), after which the relays follow their configured action.

The fault detection level for a remote input is determined by the percent of milliamp input span value entered in Level 6. Detection levels function up to 25%. If a digital input is used for local/remote switching, the detection level is 0% regardless of the configured value. The controller responds to a remote input signal failure (terminals 6 and 7) using the fault action defined in Level 6, *LDC* (Local) or *NDLH* (Nothing). If the recovery option in Level 4 is *_MAN* (Manual), the failure must be fixed and acknowledged. If the recovery option in Level 4 is *LAST*, the failure must be fixed before continuing normal operation.

4.2 Diagnostic Messages

The controller provides several diagnostic messages which alert the user to input failures or operational problems. The diagnostic messages and responses are described opposite.

4.3 Input Failure Messages and Responses

The input failure messages listed below flash alternately with the process and set point displays. When a flashing input failure message is observed; pressing the key acknowledges the message and increments the display to a non-flashing *ACP: FAIL* display. Scrolling from this display advances through the other operational displays in Level 1 which are not affected by the failure message. Scrolling through the complete operating display sequence returns to the process/set point display and restarts the flashing failure message as long as the failure conditions persist. After the failure is corrected (i.e. repair of an open thermocouple), scrolling clears the failure message and display operation returns to normal.

- *FAIL F.t.C* Failed Thermocouple (upscale burnout)
- *FAIL F.r.t.d* Failed RTD (any two leads open or no sensor present).
- *FAIL F.r.t.L* Failed RTD, Low (active lead shorted against another lead).
- *FAIL F.r.t.H* Failed RTD, High (any one lead open).
- *FAIL F.C.J.C* Failed Cold Junction Compensating Resistor.
- *FAIL F._R.L* Failed 4 to 20mA Input, Low.
- *FAIL F._R.H* Failed 4 to 20mA Input, High.
- *FAIL F.L.o* Under Voltage Failure.
- *FAIL/F.H.i* Over Voltage Failure.
- *FAIL F.r.S.L* Failed Remote Set Point, Low.
- *FAIL F.r.S.H* Failed Remote Set Point, High.

Note. Turn off power to the unit before replacing controller or repairing wiring. Failure to do so may cause a loss of calibration.

4.4 Operational Failure Messages

Failures in the general operation of the instrument are indicated by the following diagnostic messages:

- *R.C. FAIL*
This is the first display to appear after power-up if the power-up message was not suppressed in Level 6. It provides indication that the power has been off due either to a normal shut down or an accidental power failure. Pressing any key clears this message and starts the operating display sequence.
- *FAIL F.bdC*
This message appears if the A/D converter on the processor board failed its diagnostic checks. Replace controller with good unit and return bad unit for repair if this message appears.
- *FAIL F.bc.o*
This message appears if the A/D converter on the option board failed its diagnostic checks. Replace controller with good unit and return bad unit for repair if this message appears.
- *CFG CHG*
This message appears if the instrument configuration is changed while power was off. Default setup values are loaded as a result of this failure. The next scroll clears the message and allows operation and setup activity to continue.

5 DATABASE RECORD

MAIN DISPLAY	SEC. DISP. ENTRY	MAIN DISPLAY	SEC. DISP. ENTRY	MAIN DISPLAY	SEC. DISP ENTRY
LEU.2	tUnE	d.GRP		P.bnd	
				Intr	no/YES
l.r.AE.					
..r.En	no/YES	..rSt		drIU	
rAtO		bIRS		d.bnd	
CYC.t					
LEU.3	ALr5.	dISP	ALr5.	====	====
ALr1	SEt	tYPE			
t.rIP		Prty		HYS.t.	
ALr2	SEt	tYPE			
t.rIP		Prty		HYS.t.	
ALr3	SEt	tYPE			
t.rIP		Prty		HYS.t.	
ALr4	SEt	tYPE			
t.rIP		Prty		HYS.t.	
rELY	SEt	rLY.R	SEt	CntL not	rELY InSt
rLY.b	SEt	r.ACt		t.ACt	
rLY.C	SEt	r.ACt		t.ACt	
ACK-	ALr5.	ACK. 1	no/YES	ACK.2	no/YES
LEU.4	HI.Lo	oP.HI			
oP.Lo				SP-H	
SP-L		d.SP2.E	no/YES	SP.2.H	
SP.2.L		SP.2		dIG.	InPt
Lk.ob	no/YES	dLFC		C.oUt	no/YES
CFo.d		F.SP.1		F.SP.2	
t.oGL	no/YES	d.ACt		r.t.En	no/YES
P.U.HI		P.U.Lo		F.oUt	
F.PEr		r.oPt		=====	=====

...5 DATABASE RECORD

MAIN DISPLAY	SEC. DISP. ENTRY	MAIN DISPLAY	SEC. DISP. ENTRY	MAIN DISPLAY	SEC. DISP ENTRY
LEU.5	InPt.	TYPE		dEG.C	no/YES
InP.H		InP.L		d.P.—	
SC-L	no/YES	EnG.H		EnG.L	
SPAn		A..rb.	no/YES	r.b.tY	
SrC		bAL		r.SrC	
b.SrC		r.bAL		b.bAL	
LEU.6	EnbL.	AUto	tUnE n/Y	t.PAS.	
C.PAS.		P.UP..	no/YES	P..dE	
P.oUt		a.UAL		SP.tk	no/YES
drCt	ACtG n/Y	drCt	n/Y	r.U.oP.	no/YES
r.SP.E	no/YES	r.SPH.		r.SPL.	
r.F.R.		F.SPt.		F.PEr.	
LEU.7	dirG				
L.tSt	no/YES	t.CAL	no/YES	xx.x	
LEU.8	485	EnbL.	no/YES	Addr.	
bAUd				PAR.	no/YES
odd	no/YES	bCC	no/YES	=====	=====
LEU.9	CntL	HrEt		CntL.	
InPt.					
		=====	=====	=====	=====

PRODUCTS & CUSTOMER SUPPORT

A Comprehensive Product Range

Analytical Instrumentation

- **Transmitters**
On-line pH, conductivity, and dissolved oxygen transmitters and associated sensing systems.
- **Sensors**
pH, redox, selective ion, conductivity and dissolved oxygen.
- **Laboratory Instrumentation**
pH and dissolved oxygen meters and associated sensors.
- **Water Analyzers**
For water quality monitoring in environmental, power generation and general industrial applications including: pH, conductivity, ammonia, nitrate, phosphate, silica, sodium, chloride, fluoride, dissolved oxygen and hydrazine.
- **Gas Analyzers**
Zirconia, paramagnetic, infrared, thermal conductivity.

Controllers & Recorders

- **Controllers**
Digital display, electronic, pneumatic. Discrete single-loop and multi-loop controllers which can be linked to a common display station, process computer or personal computer.
- **Recorders**
Circular and strip-chart types (single and multi-point) for temperature, pressure, flow and many other process measurements.

Electronic Transmitters

- **Smart & Analog Transmitters**
For draft, differential, gauge and absolute pressure measurement. Also, liquid level and temperature.
- **I to P Converters and Field Indicators**

Flow Metering

- **Magnetic Flowmeters**
Electromagnetic, insertion type probes and watermeters.
- **Turbine Flowmeters**
- **Wedge Flow Elements**
- **Mass Flow Meters**
Transmitters, sensors, controllers and batch/display units.

Level Control

- **Submersible, Capacitance & Conductivity.**

Pneumatic Instrumentation

- **Transmitters**
- **Indicating Controllers**
- **Recording Controllers**

Customer Support

ABB Instrumentation provides a comprehensive after sales service via a Worldwide Service Organization. Contact one of the following offices for details on your nearest Service and Repair Centre.

United Kingdom

ABB Instrumentation Limited
Tel: +44 (0)1480 475321
Fax: +44 (0)1480 470787

United States of America

ABB Automation Inc.
Instrumentation Division
Tel: +1 215-674-6000
Fax: +1 215-674-7183

Italy

ABB Instrumentation SpA
Tel: +39 (0) 344 58111
Fax: +39 (0) 344 58278

Client Warranty

Prior to installation, the equipment referred to in this manual must be stored in a clean, dry environment, in accordance with the Company's published specification. Periodic checks must be made on the equipment's condition.

In the event of a failure under warranty, the following documentation must be provided as substantiation:

1. A listing evidencing process operation and alarm logs at time of failure.
2. Copies of operating and maintenance records relating to the alleged faulty unit.



ABB Instrumentation Ltd
St. Neots
Cams.
England, PE19 3EU
Tel: +44 (0) 1480 475321
Fax: +44 (0) 1480 217948

**ABB Automation Inc.
Instrumentation Division**
125 E. County Line Road
Warminster, PA 18974 USA
Tel: +1 215-674-6000
Fax: +1 215-674-7183

ABB Instrumentation SpA
22016 Lenno
Como
Italy
Tel: +39 (0) 344 58111
Fax: +39 (0) 344 58278

The Company's policy is one of continuous product improvement and the right is reserved to modify the information contained herein without notice.

© ABB 2000

Printed in UK (03.00)