

Specification DataFile

- **1 to 4 pens**
 - full application flexibility
- **NEMA 4X/IP66 construction**
 - hose-down protection
- **Analog, relay outputs, digital inputs and transmitter power supply as standard**
 - range of inputs and outputs built in
- **Multiple 6-digit indicator panels**
 - continuous display of all signal values
- **0.1% measurement accuracy**
 - precise process information
- **High noise immunity**
 - robust, dependable operation
- **RS485 MODBUS serial communications**
 - open systems compatibility
- **Totalizers and math functions built-in**
 - fully integrated solutions

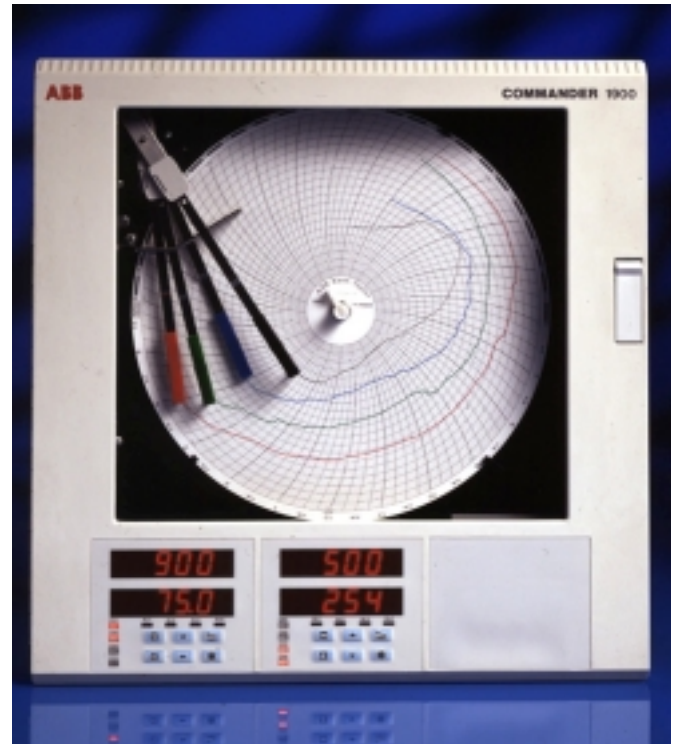

COMMANDER 1900 – a rugged, reliable recorder with the full capability to meet your application needs

COMMANDER 1900

The COMMANDER 1900 is a fully programmable circular chart recorder for up to four process signals. The COMMANDER's straightforward operator controls and robust construction make it suitable for a variety of industrial environments. Excellent standard facilities are complemented by a powerful range of options to give the flexibility to match your application.

Simple Operation



Comprehensive Process Information

The COMMANDER lets you see the status of your process at a glance: **high visibility 6-digit displays** provide a clear indication of up to four process values simultaneously and active alarms are signalled by flashing LED's below the main display.



The clearly-labelled **tactile keypad** gives direct access for operator adjustments and configuration programming, without the need to open the recorder's door. Clear text prompts on the digital displays guide the user around the various menus. A **password-protected security system** prevents unauthorized access to configuration adjustment menus.

The **chart** is easily set up to show the information you need in the way you want. Pen ranges are individually set to give the best resolution for each signal; the time per revolution can be selected between 1 hour and 32 days. Additionally a **true time event pen** facility enables one pen to be set up as a 3-position event marker on the same time line as Pen 1.

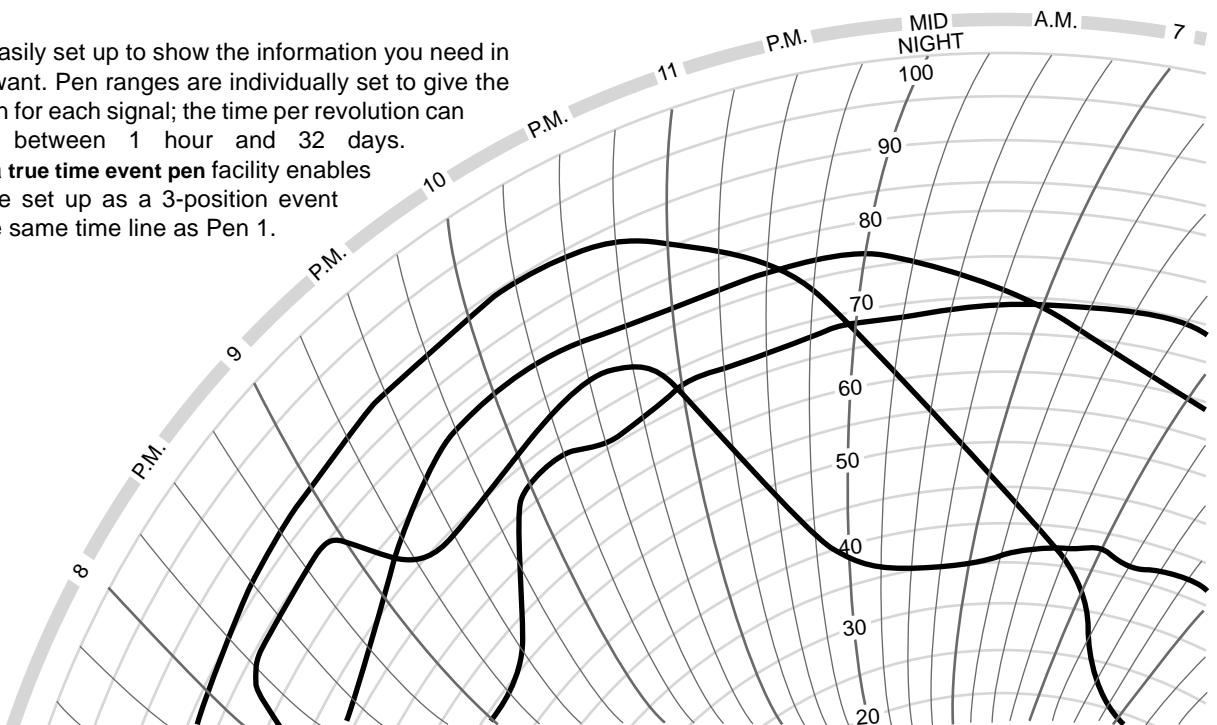

Flexibility to Solve Problems

The COMMANDER 1900 offers seamless integration of loop functionality to solve process problems, eliminating the need for auxiliary devices.

User configurable **math functions**, mass flow calculations and RH tables are all fully supported.

Totalizers, Math and Logic

Integrating fluid flow to calculate total volume is performed by the **built-in totalizers** available for each channel. Relays can be assigned to increment or reset external counters to match the recorder's totalizer values.

Logic capability allows interlocking and integration of discrete and continuous functions to solve a wide range of process problems.

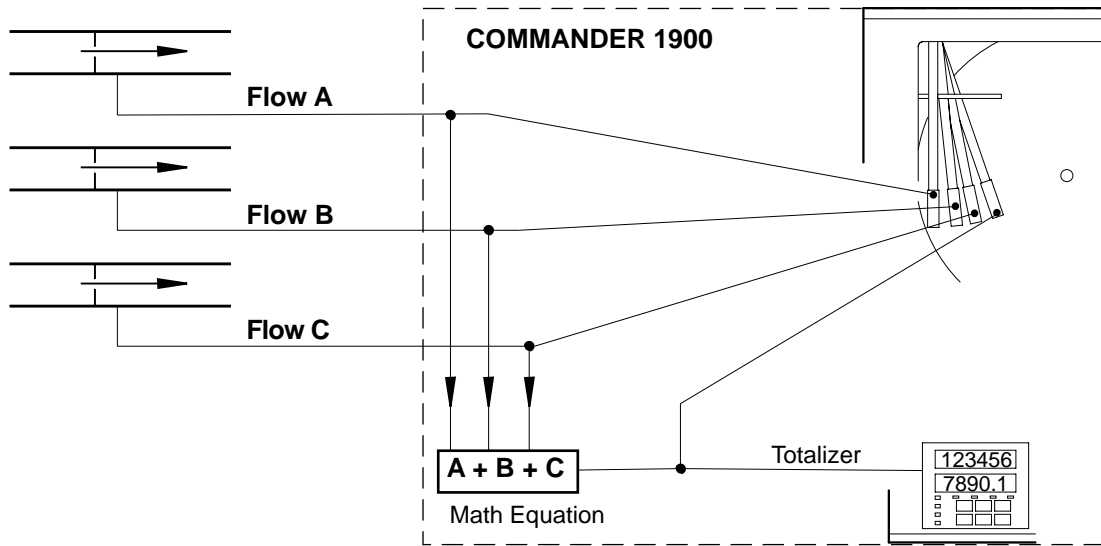

Summation of Three Flows

Timers and Clock

The COMMANDER offers two event timers driven by the recorder's **real-time clock**. The timers can be configured to operate relays, start/stop the chart or trigger other actions within the recorder.

MODBUS RS485 Communications

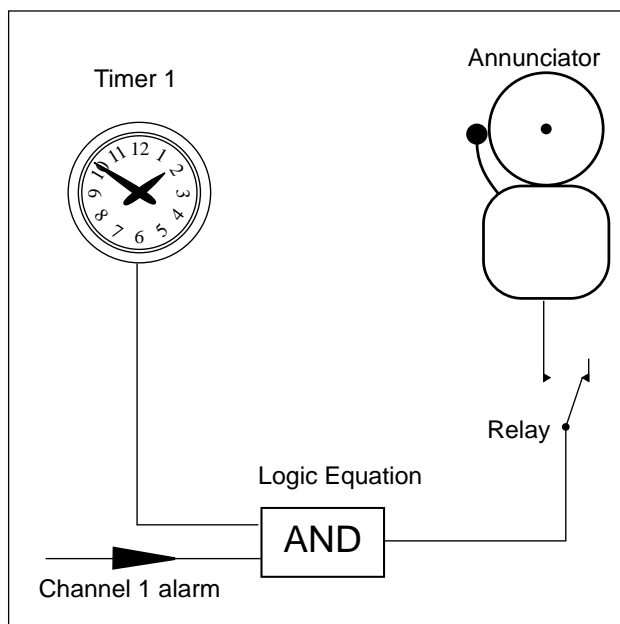

Alarm annunciation enabled during night hours only.

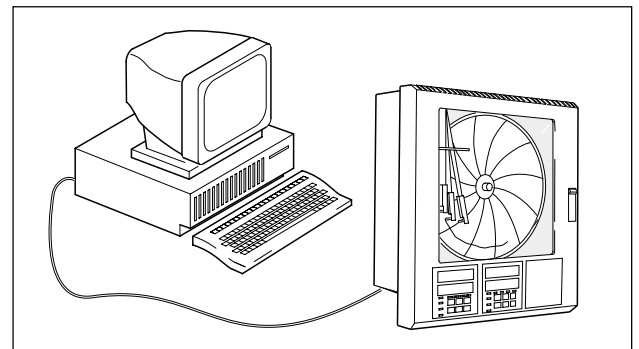

Communications with PCs or PLCs are achieved via the **RS485 serial communications** link, enabling the COMMANDER to serve as the front end of plant-wide data acquisition systems. Using MODBUS RTU protocol all process inputs and other variables can be continuously read by a host PC running any of a wide variety of standard SCADA packages.

Built to Meet Your Needs

The COMMANDER's modular architecture gives rise to a high level of hardware choice: up to five i/o modules can be added to the basic instrument.

The **standard input/output module** supplied with every pen comes complete with a fully isolated analog input, a relay output, transmitter power supply, isolated analog retransmission and two digital inputs. Further input and output capability is provided by a **range of plug-in modules**:

- **Analog input and relay** – for use with math functions
- **Four relays** – channel alarm outputs
- **Eight digital inputs** – linked using logic equations
- **Eight digital outputs** – TTL level alarm outputs
- **MODBUS RS485 communications** – interfaces with P.C.s

Expandable for the Future

The COMMANDER may be quickly upgraded to meet your changing process requirements.

Additional recording channels, math capability or input and output functions can be retrofitted on-site using **plug-in cards** and easily fitted pen arms. Input calibration data is stored on each card, allowing quick changes to input cards without the need for recalibration.

Changes to input sensors or recording procedures are accommodated by reconfiguration using the main keypad.



Designed to Survive

NEMA 4X protection ensures the COMMANDER can survive in the harshest environments and makes the recorder ideal for use in panels which are regularly hosed down. The **tough, acid-resistant case** and secure cable-entry glands maintain the NEMA 4X rating for wall-mounted or pipe-mounted instruments.

Noise Immunity

Recording accuracy is maintained in noisy industrial environments due to the **advanced EMC shielding** within the recorder. The power supply has been designed to give excellent protection from power spikes and brownouts and all configuration and status information is held in nonvolatile memory to ensure rapid recovery after a power failure.

Easy to Install

A choice of mounting options enables simple installation of the recorder in a panel, on a wall or on a pipe. **Detachable terminal blocks** allow for trouble-free connection of input and output wiring, with mains isolation provided by a power switch within the instrument.

Minimal Maintenance

Excellent long-term stability keeps recalibration to a minimum, cutting the costs of ownership. User-selectable chart speeds and long-life pens combine to limit usage of consumables.

Built-in Quality

The COMMANDER 1900 is designed, manufactured and tested to the highest quality standards, including ISO 9001, and is guaranteed by a 2 year parts and labour warranty.

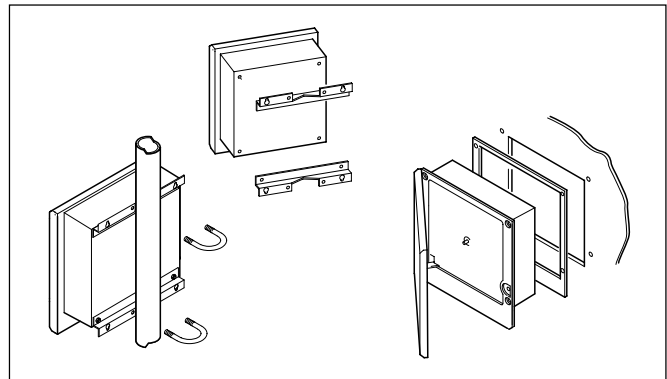

Summary

1, 2, 3 or 4 pens
 10" Chart size
 Standard i/o with each pen includes:
 Analog input, analog output, transmitter power supply,
 relay output and 2 digital inputs.

General Specification

Construction

Size: 15.23" (h) x 15.04" (w) x 5.57" (d)
 (386.8 x 382.0 x 141.5mm)
 Weight: 18lb (8.2kg)
 Case material: Glassfiber-filled reinforced polyester
 Window Material: Polycarbonate
 Door latch: High-compression with optional lock

Environmental

Operational temperature range: 32° to 130°F (0° to 55°C)
 Operational humidity range: 5 to 95%RH
 (non-condensing)
 5 to 80%RH (chart only)
 Case sealing: NEMA 4X (IP66)
 Fast transients: IEC 801-4 Level 3

Installation

Mounting options: Panel, wall or pipe
 Terminal type: Screw
 Wire size (max): 14 AWG (i/o), 12 AWG (power)

Operation and Configuration

Programming method: Via front panel keys
 Security: Password protected menus

Safety

General safety: IEC348
 Dielectric: 500V dc (channel/channel)
 2kV dc (channel/ground)
 Memory protection: Nonvolatile EEPROM
 Approvals: CSA (optional)
 CE

Power Supply

Voltage: 115/230V ac ±15%, 50/60Hz
 Consumption: < 40 VA (typical for full spec.
 unit)
 Line interruption: Up to 60ms

Process Inputs and Outputs

General

Noise Rejection: Common mode > 120dB at 50/
 60Hz
 Normal (series) mode > 60dB at
 50/60Hz
 CJC rejection ratio: < 0.05°C/°C
 Sensor break protection: Upscale or downscale drive
 Out of range detection: 0 to 100% of engineering span
 Temperature stability: < 0.02% of reading/°C or 1µV/
 °C
 Long-term drift: < 0.01% of reading 10µV
 annually
 Input impedance: > 10 MΩ (mV and V inputs)
 100 Ω (mA input)

Analog Inputs

Signal types: mV, V, mA, Ω
 Thermocouple types: B, E, J, K, N, R, S, T
 Resistance Thermometer: Pt 100
 Other linearizations: x^{1/2}, x^{3/2}, x^{5/2}, linear
 Sample interval: 250ms per channel
 Dielectric: 500Vdc channel/channel
 Digital Filter: 0 to 60s programmable

2-Wire Transmitter Power Supplies

Number: 1 per channel
 Voltage: 24Vdc nominal
 Drive: Up to 25mA
 Isolation: 500Vdc channel/channel

Type	Range Lo	Range Hi	Min. Span	Accuracy
mV	0	150	5	±0.1% reading or 10µV
V	0	5	0.1	±0.1% reading or 20µV
mA	0	50	1	±0.2% reading or 0.2µA
Ohms (low)	0	750	20	±0.2% reading or 0.1Ω
Ohms (high)	0	10k	400	±0.5% reading or 10Ω

Type	°C		°F		Accuracy (excl. CJC)
	Range Lo	Range Hi	Range Lo	Range Hi	
B	-18	1800	0	3270	±2.0°C (above 200°C)
E	-100	900	-140	1650	±0.5°C
J	-100	900	-140	1650	±0.5°C
K	-100	1300	-140	2350	±0.5°C
N	-200	1300	-325	2350	±0.5°C
R	-18	1700	0	3000	±1.0°C (above 300°)
S	-18	1700	0	3000	±1.0°C (above 200°C)
T	-250	300	-400	550	±0.5°C
PT100	-200	600	-325	1100	±0.5°C

Analog Outputs

Type: 4 to 20 mA
 Accuracy: $\pm 0.1\%$
 Maximum load: 750 Ω
 Dielectric: 500V dc

Relay Outputs

Type: SPDT
 Rating (with non-inductive load): 5A at 115/230Vac

Digital Inputs

Type: TTL or volt-free
 Minimum pulse: 250ms
 Dielectric: 500Vdc between modules, no isolation within module

Digital Outputs

Type: 5V TTL
 Rating: 5mA per output
 Dielectric: 500Vdc between modules, no isolation within module

Serial Communications

Connections: RS485, 4 wire
 Protocol: MODBUS RTU

Pneumatic inputs/outputs

Type: 3 to 15 psig I/P, 3 to 15 psig P/I
 Mounting: External DIN rail on rear of unit

Recording System

Pens

Number: 1, 2, 3, or 4 (red, blue, green, black)
 Response: 7 seconds (full scale)
 Resolution: 0.1% steps
 Pen lift: Motor-driven, with optional auto-drop

Event Pens

Standard: 3-position event recording on any channel
 Real time: 3-position event recording on the same time line as Pen 1

Chart

Chart size: 10 in. or 105mm
 Chart speed: 1 to 167 hours or 7 to 32 days per revolution

Display and Operator Panels

Displays

Number: 2 (1 or 2 pens) or 4 (3 or 4 pens)
 Type: 6-digit red LED, 0.56 in. (14mm) high
 Status indicators: Indicate channel number on display
 Alarm indicators: Indicate channel with active alarms

Panel keys

Function: Programming access, increment/decrement, pen lift and user-defined function key.

Alarms and Logic

Alarms

Number: 4 per channel
 Type: High/low process, fast/slow rate of change
 Adjustments: Hysteresis, time delay

Logic Equations

Number: 4
 Function: OR, AND
 Inputs: Alarm states, digital inputs, totalizers, logic
 Outputs: Relays, digital outputs, chart stop, alarm acknowledge

Advanced Software Functions

Totalizers

Number: 1 per pen
 Size: 99,999,999 max.
 Output: External counter driver, "wrap" pulse signal

Math

Number of eqns.: 4
 Type: +, -, x, \div , low & high select, max, min, average, mass flow, RH

Timers

Number: 2
 Type: Real-time clock driven event, adjustable duration
 Output: Relay, digital output, logic equation

Option Module

Number: 5 plus 1 x standard input/output module
 Connection: Plug in cards with detachable connection blocks

Option Module Types	i/o per module							Max. No. per instrmt
	Analog i/p	Analog o/p	Trans. PSU	Relays	Digital i/p	Digital o/p	Comms.	
Standard i/o	1	1	1	1	2			3
Analog i/p + relay	1			1				5
4 relays				4				2
8 digital i/p					8			3
8 digital o/p						8		3
RS485 comms.							1	1
1901J (non-upgradeable)	1							

Ordering Guide

PART 1

COMMANDER 1900 Recorder		19XX	X	X	X	X	X	X	X	X	X	X	X	X	XXX
Recorders †	One Pen (Red)	11													
	Two Pens (Red & Green)	12													
	Three Pens (Red, Green, Blue)	13													
	Four Pens (Red, Green, Blue, Black)	14													
Chart Type	Standard		J												
	KPC 105 PX and PXR type charts		K												
	Chessell Brand charts		C												
Electrical Code	Standard			A											
	CSA approval			B											
	UL approval			U											
	CSA/FM Class 1 Div. 2			F											
Option Module	None					0									
	Additional Modules –	<i>Complete PART 2</i>													A
Options	None														0
	Totalizer														3
	Totalizer, Maths & Timer														B
Door Lock	Not Fitted														1
	Fitted														2
Power Supply	115V A.C.														1
	230V A.C.														2
	24V A.C.														3
	115V A.C. with On/Off Switch														4
	230V A.C. with On/Off Switch														5
	24V A.C. with On/Off Switch														6
Special Settings	Company Standard														STD
	Customer Setting														CUS
	Special														SXX

† Each pen fitted has an associated standard Input/Output module comprising Analog input, Analog output, Relay, Transmitter Power Supply and Two Digital Inputs. Additional Input/Output modules may be fitted in the unused Module Positions as required. These additional modules should be specified in PART 2 of the Ordering Guide

PART 2 Additional Modules

	Module Type							
Module Position 2 / Channel 2 Input*	0	1	2					
Module Position 3 / Channel 3 Input*	0	1	2					
Module Position 4 / Channel 4 Input *	0	1	2	3	4	5	6	
Module Position 5	0	0	2	3	4	5		
Module Position 6	0	2	4	5	8			

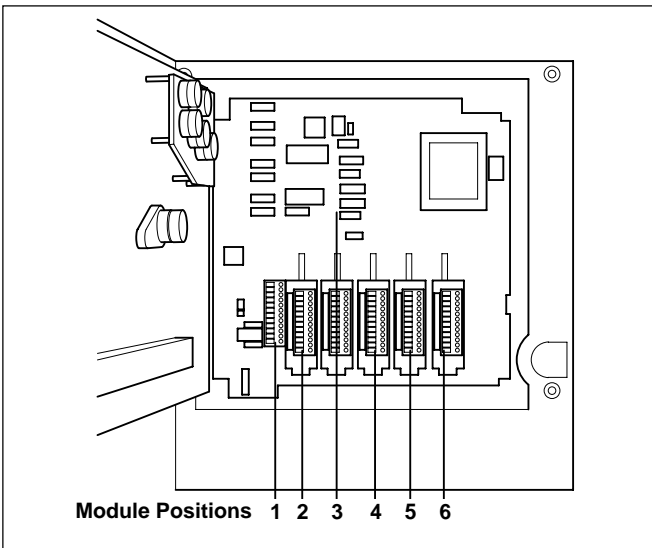

Key to Module Types

- 0** No module fitted / Pen input channel *
- 1** Standard Input/Output
- 2** Analog Input (Math input) + Relay
- 3** Four Relays
- 4** Eight Digital Inputs
- 5** Eight Digital Outputs
- 6** True Time Event Pen (Violet)
- 8** MODBUS RS485 Communications

* On 2, 3 or 4 pen instruments a standard I/O module is always fitted in the corresponding module position (enter '0' in the corresponding order code field).

Example 1 9 1 3 J A A 0 1 1 0 0 3 0 8 STD
 3 pen _____
 4 relays _____
 Module RS485 communications _____

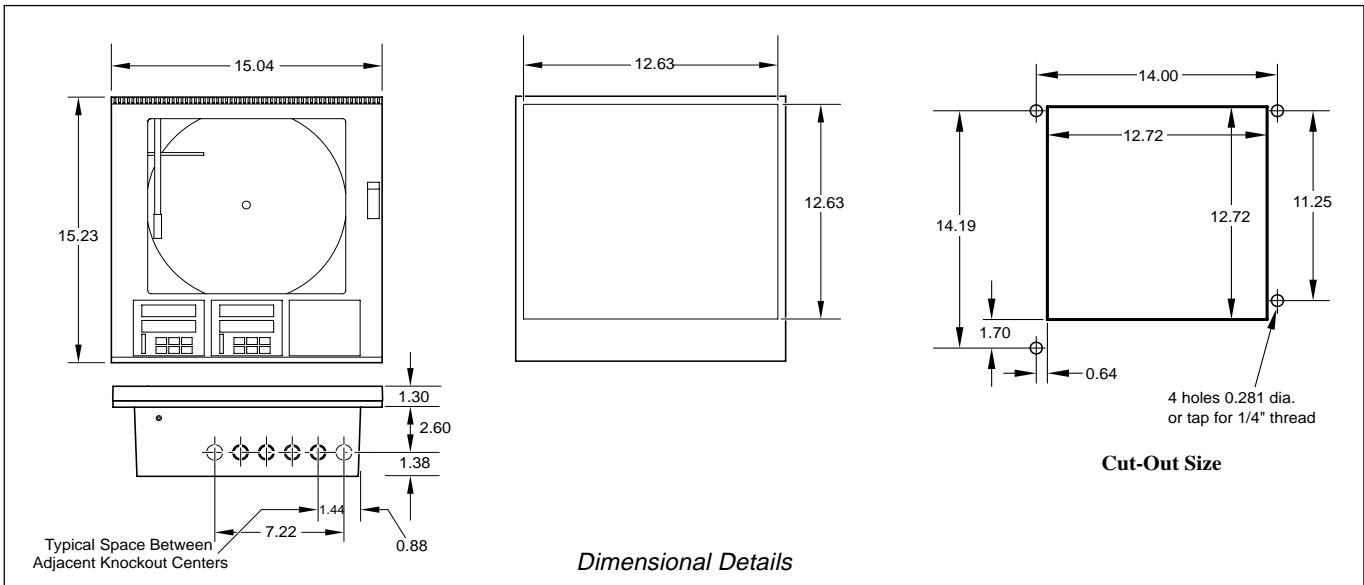
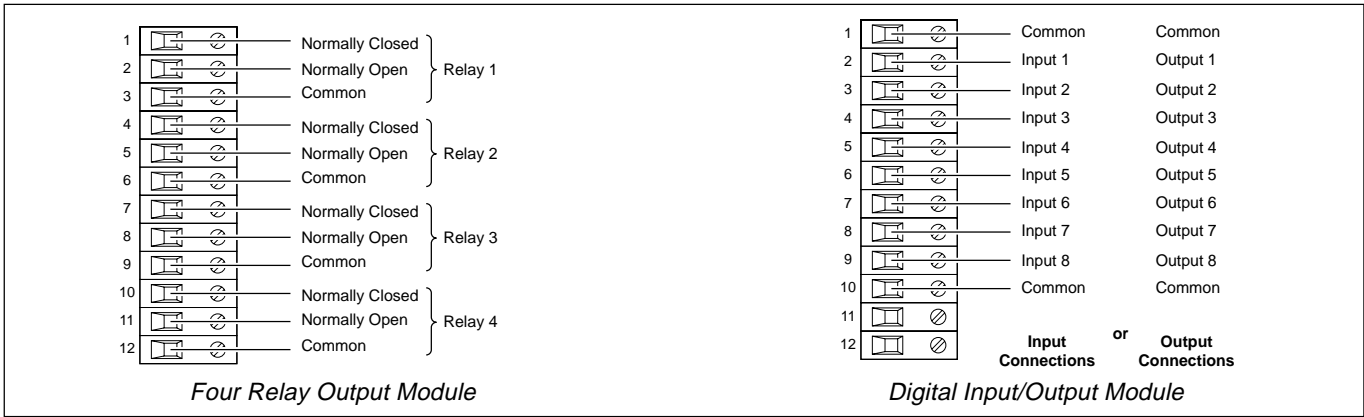
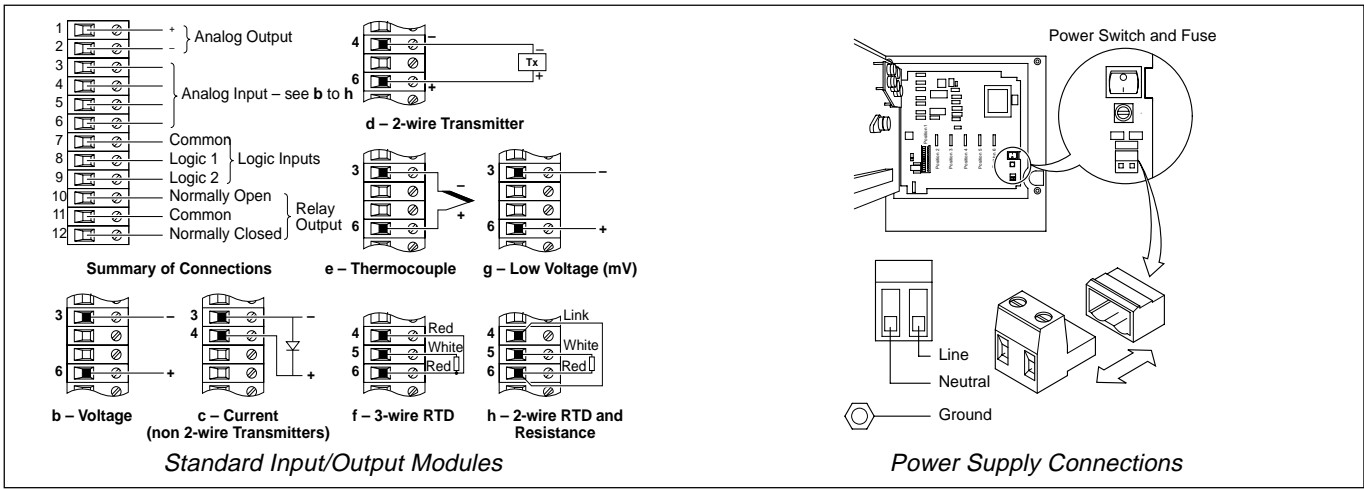

The Company's policy is one of continuous product improvement and the right is reserved to modify the information contained herein without notice.
© ABB 1999 (6.99)

ABB Instrumentation Ltd
Howard Road
St. Neots, Cambs.
England, PE19 3EU
Tel: +44 (0)1480-475-321
Fax: +44 (0)1480-217-948

**ABB Automation Inc
Instrumentation Division**
125 E. County Line Road
Warminster, PA 18974 USA
Tel: +1 215-674-6000
Fax: +1 215-674-7183

ABB Instrumentation
22016 Lenno
Como
Italy
Tel: +39 (0)344-58111
Fax: +39 (0)344-58278